



CROWN

HIGH-WALL DUCTLESS AIR CONDITIONING & HEATING SYSTEM OWNER'S MANUAL

Models:

CROWN09HP230V1A

CROWN12HP230V1A

CROWN18HP230V1A



Thank you for choosing a Crown High-Wall Air Conditioning & Heating System!

You can feel confident in your selection because the same pride in craftsmanship and engineering knowledge that goes into millions of other Gree installed products worldwide has gone into your unit.

Please read this owner's manual carefully before operation and retain it for future reference.

Table of Contents

<i>Introduction</i>	<i>2</i>
<i>Nomenclature</i>	<i>2</i>
<i>Safety Precautions</i>	<i>3-4</i>
<i>System Parts</i>	<i>5</i>
<i>System Functions</i>	<i>6-7</i>
<i>Operation of Wireless Remote Controller</i>	<i>8-16</i>
<i>Operation of Smart Control</i>	<i>17-21</i>
<i>Troubleshooting</i>	<i>22-23</i>
<i>Care and Cleaning</i>	<i>24</i>
<i>Energy Saving Tips</i>	<i>25</i>
<i>Warranty</i>	<i>Back</i>

INTRODUCTION

Superior Design for Superior Performance

Gree's Crown High-Wall Ductless Heat Pumps and Air Conditioners are beautifully designed to deliver effective cooling or heating, while fitting unobtrusively into any decor.

Your Crown unit offers quiet, energy-efficient comfort for one room or one individual area of any living space. To speed the process of bringing conditioned air exactly where you want it, the unit features both horizontal and vertical air flow control. Customizable mode controls allow you to adjust fan speeds, special sleep-time settings and more, all through the easy-to-use wireless remote controller.

There's even an X-fan feature, Power Failure Memory and other advanced capabilities to make the Crown system even more versatile, for year-round comfort. Flexibility, intelligent design and Gree innovation make the Crown your best choice for creating ideal climate conditions.

The Crown series is WiFi enabled. It allows you to monitor and change settings through on-screen virtual controls from smart phones or tablets with Gree-Smart App.

NOMENCLATURE

Example: CROWN12HP230V1A O

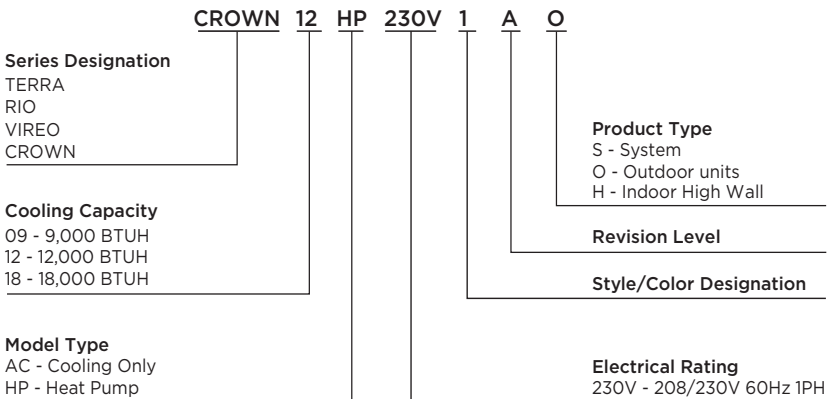

SAFETY PRECAUTIONS

Please read the following before operation.

Recognize safety information.  This is the safety-alert symbol. When you see this symbol on the unit and in instructions or manuals, be alert to the potential for personal injury. Understand these signal words: **DANGER**, **WARNING**, and **CAUTION**. These words are used with the safety-alert symbol.

DANGER identifies the most serious hazards which will result in severe personal injury or death.

WARNING signifies hazards which could result in personal injury or death.

CAUTION is used to identify unsafe practices which may result in minor personal injury or product and property damage.

NOTE is used to highlight suggestions which will result in enhanced installation, reliability, or operation.

NOTE: Your actual air conditioning & heating system and related devices may differ from the images shown in this manual.

WARNING

This appliance is not intended for use by children without responsible adult supervision. Proper care should be taken to ensure safety.

WARNING

Heat pumps, air conditioners & heating equipment should be installed, started up, and serviced only by qualified installers and service technicians. Air conditioning, heat pumps and refrigeration systems are hazardous due to high voltage electrical components, high refrigerant pressures, and moving parts.

SAFETY PRECAUTIONS

Please read the following before operation.

WARNING

- *Disconnect electrical power to the indoor and outdoor units before performing any maintenance or cleaning.*
- *Do not attempt to repair the Gree system yourself. Incorrect repairs may cause electric shock or fire. Contact a qualified service technician for all service requirements.*
- *Keep combustible materials away from the unit.*

CAUTION

- *Do not put hands or any objects into the air inlets or outlets. This may cause personal injury or damage the unit.*
- *When cleaning, be careful not to splash water on the unit. Doing this may cause electric shock or damage to unit.*
- *Do not use or place any flammable, combustible or noxious substance next to the unit.*
- *In the event of a failure (burning smell, etc.), immediately disconnect all electrical power to indoor and outdoor units.*
- *Never try repairing the system yourself; contact a qualified service technician for all repairs.*

SYSTEM PARTS

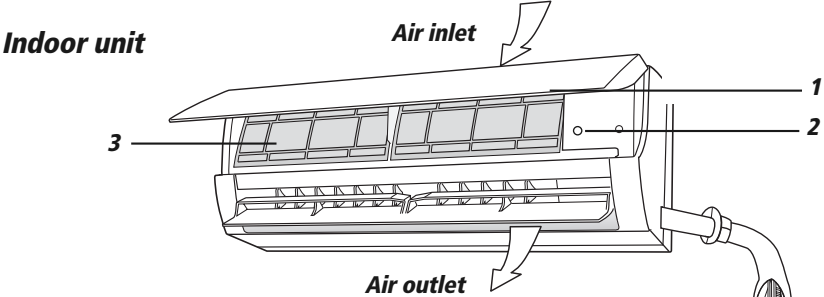

Part Name

- 1. Front Panel
- 2. Aux Button
- 3. Filter
- 4. Remote Controller
- 5. Inter-Connection Wire
- 6. Drain Hose
- 7. Refrigerant Lines



Outdoor unit

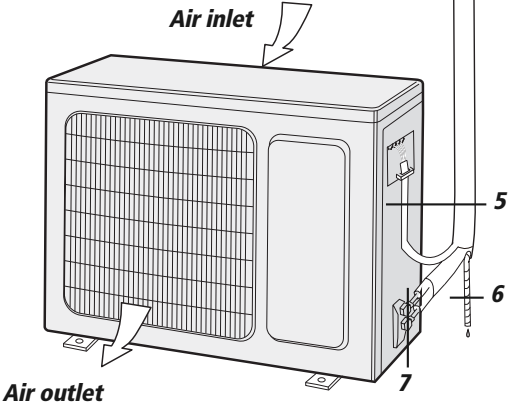

SYSTEM FUNCTIONS

WHISPER QUIET

Not only are the Gree systems energy efficient but they are quiet too. Crown High-Wall units operate with sound pressure levels starting as low as 22 dB(A).

MULTI FAN SPEEDS

Whether operating in either Cooling or Heating mode, the indoor fan can be set to your choice of seven different speeds (Ultra-Low, Low, Low-Medium, Medium, Medium-High or High) to achieve maximum comfort.

INTELLIGENT PRE-HEATING

The Crown system guards against the annoying cool air blown into the room in heating mode. The system constantly monitors the discharge air temperature. It will delay the indoor fan until the indoor coil has warmed up to prevent blowing uncomfortable cool air into the room.

I FEEL MODE

The unit will sense room temperature at the remote controller instead of at the indoor unit. It then adjusts airflow and temperature accordingly for the ultimate in personal comfort control and energy savings.

SWING LOUVER

The unit has adjustable swing louvers which can be controlled from the wireless controller. Vertical and horizontal swing louvers allows five different air discharge directions including Continuous Sweep. Maximize comfort by adjusting the direction of airflow in the room by moving the louvers up or down, right or left.

TIMER MODE

The unit can be programmed to turn ON or OFF after a specific amount of time. The time period is adjustable between one half and 24 hours.

SYSTEM FUNCTIONS

MODE BUTTON

The unit can be set to five different operating modes: HEAT, COOL, DRY, FAN ONLY and AUTO.

NOTE: AUTO MODE has fixed setpoints of 68° F heating and 78° F cooling, which are not adjustable. The system will automatically select heating or cooling to maintain room temperature within this band.

SLEEP MODE

The Crown offers four selectable sleep modes for your comfort. The unit will automatically adjust room temperature during your sleep time. This slight change in temperature will not affect your comfort level due to the natural effects that sleeping has on the body, but it will save on energy consumption and will lower electric bills.

X-FAN MODE

When operating in humid areas, Crown has a Dry Coil function that will allow the indoor fan to run for a pre-determined amount of time after the unit is turned off (cooling or dry modes) to ensure that additional moisture is removed from coil.

FAHRENHEIT °F / CELSIUS °C

The remote controller and Crown indoor wall unit displays can be set to display in either °F or °C.

LOCK MODE

The wireless remote controller has a Lock feature. The Lock averts unauthorized access or tampering with system settings.

AGENCY LISTINGS

All systems are listed with AHRI (Air conditioning, Heating, and Refrigeration Institute) and are ETL certified per UL Standards.

OPERATION OF WIRELESS REMOTE CONTROLLER

REMOTE CONTROLLER

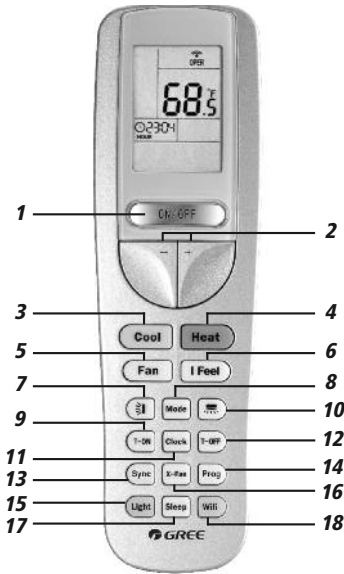

Part Name

1. ON/OFF Button
2. +/- Button
3. Cool Button
4. Heat Button
5. Fan Button
6. I Feel Button
7. Up & Down Swing Button
8. Mode Button
9. Timer-On Button
10. Left & Right Swing Button
11. Clock Button
12. Timer-Off Button
13. Sync Button
14. Prog Button
15. Light Button
16. X-Fan Button
17. Sleep Button
18. WiFi Button

INTRODUCTION FOR ICONS ON DISPLAY SCREEN

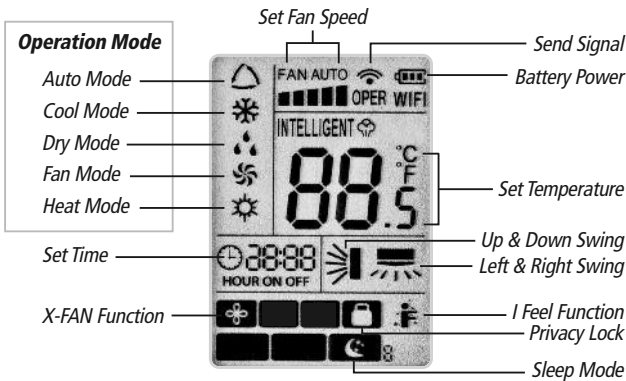

OPERATION OF WIRELESS REMOTE CONTROLLER

MATCHING INSTRUCTIONS

The Crown models require the wireless remote controller to be matched to the indoor wall unit before beginning any operations, otherwise the Crown indoor wall unit will not accept commands from the remote controller. Follow the instructions below to automatically match the remote controller to the Crown indoor wall unit:

1. Turn on electrical power to the Crown indoor and outdoor units. The Crown indoor wall unit will power up in Off (or Standby) mode.
2. Hold the remote controller 5 to 6 feet from the Crown indoor wall unit.
3. Point the remote controller at the Crown indoor wall unit and press the "Sync" button for 3 seconds.
4. The Crown indoor wall unit will provide 3 beeps to signal a successful match.
5. Press the Power ON button on the remote controller. The green indicator light will display on the Crown indoor wall unit.
6. The remote controller is matched and ready for use.

If the Crown indoor unit and remote controller fail to match, then check the remote controller batteries, move closer and repeat the matching process again.

NOTE: This is a one-time requirement only. The remote controller and Crown indoor wall unit need to be successfully matched only once.

REMOTE CONTROLLER OPERATIONS

The wireless remote controller is sleek, versatile and allows you to change room temperatures and functions on your Crown system from the palm of your hand. The large LCD display and buttons make it easy-to-understand and easy-to-use.

The remote controller is set from factory to display temperatures in °F. If °C is desired, turn the remote controller **OFF** with the **ON/OFF** button and then press "**MODE**" and "**—**" buttons on the remote simultaneously for 5 seconds.

ON/OFF BUTTON

When the system is in **OFF** mode, the remote controller will display the time and last room setpoint. When you press the **ON/OFF** button, the unit will start in the last operating mode and room setpoint.

NOTE: If the **ON/OFF** button is pressed too soon after a stop, the compressor will not start for 3 to 5 min. due to the inherent protection against frequent compressor cycling.

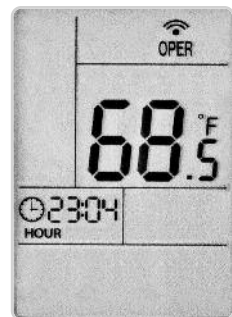

ON Mode Display

OPERATION OF WIRELESS REMOTE CONTROLLER

LOCK MODE

The Privacy Lock prevents unauthorized access to the unit controls and prevents tampering with system settings. The remote controller can be locked by pushing the "+" and "-" buttons simultaneously for 5 seconds. The Privacy Lock icon will be displayed on the remote controller. Repeat the process to unlock the remote controller.

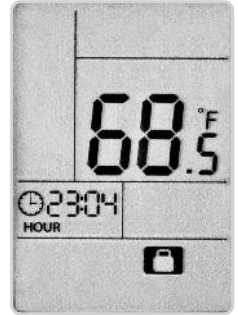

Privacy Lock Display

MODE BUTTON

Use the "MODE" button to select one of the available modes. The selected mode will be displayed on the remote controller and the appropriate light will illuminate on the front display panel.

AUTO – Unit will automatically select heating or cooling to maintain room temperature between 68°F and 77°F. The remote controller will display the Auto Mode icon with no setpoint. The front panel display will show "77."

COOL – To cool to selected setpoint and remove moisture. System varies compressor speed to maintain desired temperature.

HEAT – To heat to selected room setpoint. System varies compressor speed to maintain desired room temperature.

FAN ONLY – To circulate air without heating or cooling. Use Fan Speed button to select speed from low to high.

DRY – Select **DRY MODE** to increase moisture removal during warm humid conditions.

1. If the Room Temperature is more than 4°F above the set temperature, the system will be operating in cooling mode with low fan speed.
2. If the Room Temperature is between 4°F higher than, and 4°F less than, the set temperature, the system will cycle 6 minutes **ON** and 4 minutes **OFF** in cooling mode. The indoor fan will be at low speed.
3. If the Room Temperature is more than 4°F below the set temperature, the system will be **OFF** and the indoor fan will be at low speed.

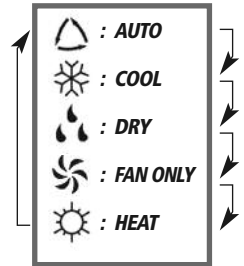

Icons Displayed

OPERATION OF WIRELESS REMOTE CONTROLLER

VERTICAL SWING LOUVERS

Press the Vertical Swing Louver button to select continuous air sweep up and down. The Swing Louver icon  will be displayed. Press this button again to cancel.

For fixed air direction mode, press the OFF button to turn the unit OFF. Press the Vertical Swing Louver and the + buttons simultaneously until the Vertical Swing Louver icon  flashes. Press the ON button to turn the unit ON. Press the Vertical Swing Louver button to select air discharge direction as shown below:

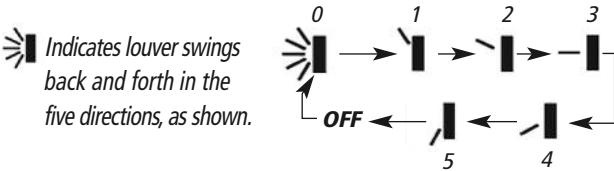

HORIZONTAL SWING LOUVERS

Press the Horizontal Swing Louver button to select continuous air sweep left to right. The Swing Louver icon  will be displayed. Press this button again to cancel.

For fixed air direction mode, press the OFF button to turn the unit OFF. Press the Horizontal Swing Louver and the + buttons simultaneously until the Horizontal Swing Louver icon  flashes. Press the ON button to turn the unit ON. Press the Horizontal Swing Louver button to select air discharge direction as shown below:

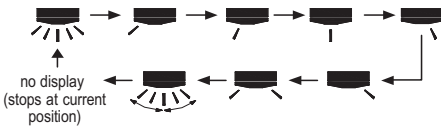

SLEEP MODE

The Crown system will automatically adjust room temperature during your sleep time. This slight change in temperature will not affect your comfort level due to the natural effects that sleeping has on the body, but it will save on energy consumption and will lower your electric bill. The Crown System has four Sleep Modes to select from. Press the SLEEP button to select Sleep 1, Sleep 2, Sleep 3, Sleep 4 modes or Cancel. The SLEEP  icon will appear.

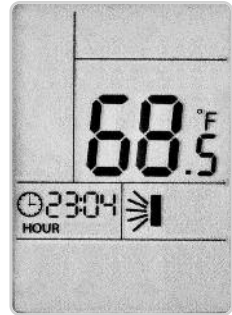

Vertical Louver Display

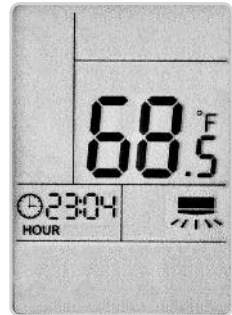

Horizontal Louver Display

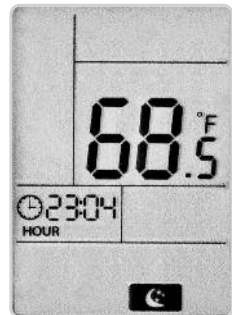

Sleep Mode Display

OPERATION OF WIRELESS REMOTE CONTROLLER

TRADITIONAL MODE - SLEEP 1

In Traditional Mode the unit will slowly relax the room set temperature by up to 4° F until Sleep Mode is cancelled.

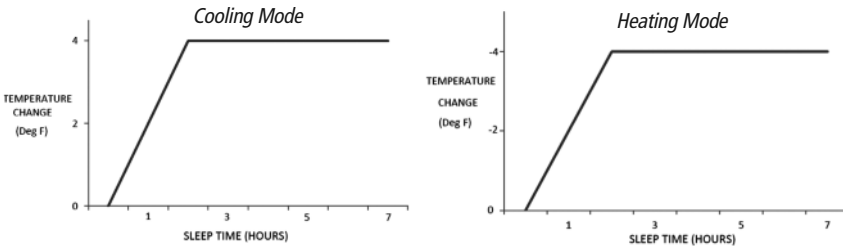

EXPERT MODE - SLEEP 2

In Expert Mode the unit will adjust the room set temperature at a rate based on the starting set temperature value. Sleep Mode will continue until cancelled.

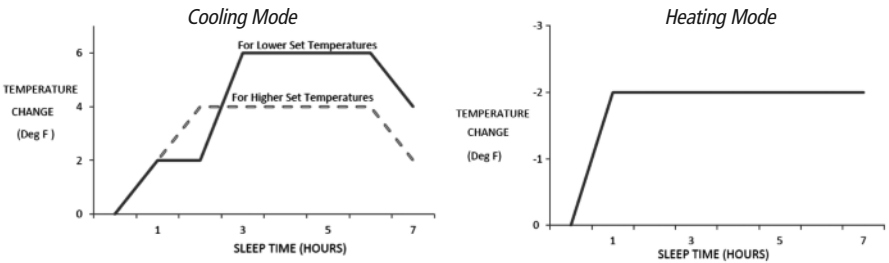

DIY MODE - SLEEP 3

You will be required to enter eight (8) room setpoint values for eight (8) hours of run time. The last room setpoint value will be maintained until sleep mode is cancelled.

In Sleep Mode 3, press "Prog" button to enter setup mode. The remote controller will display "1:00" in the time location. Use the "+" and "-" buttons to select the desired room setpoint for the first hour of run time. Then press the "Prog" button to save the setpoint.

The remote controller time display will change to "2:00." Once again, use the "+" and "-" buttons to select the desired room setpoint for the second hour of run time, and press the "Prog" button to again save the setpoint.

Repeat this sequence for the eight (8) room setpoint values. After all eight (8) values have been entered, the remote controller will automatically revert to standard time and temperature display, and the Sleep 3 Mode will begin.

At any time, you may press the "ON/OFF," "Mode," "Timer" or "Sleep" buttons to cancel the Sleep 3 Mode.

OPERATION OF WIRELESS REMOTE CONTROLLER

NOTE: During this procedure, if no button is pressed within 10 seconds, remote controller will automatically exit the sleep curve setting and resume original display. If ON/OFF, MODE, TIMER, SLEEP, COOLING or HEATING button is pressed during the setting or inquiry procedure, remote controller will also exit the sleep curve setting.

SIESTA MODE - SLEEP 4

In Siesta Mode the Crown System will automatically change the room temperature every 30 minutes based on the room temperature setting. Sleep Mode will continue until cancelled.

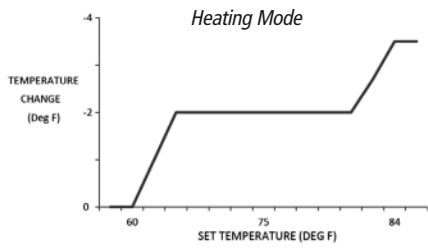
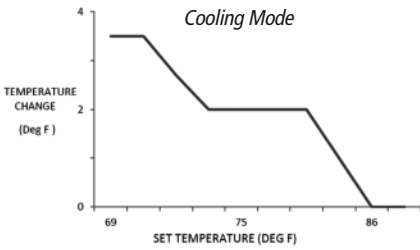

NOTE: Sleep function will be disabled if the air conditioner is restarted after power failure; Sleep function can not be set in AUTO mode.

I FEEL MODE

Press this button to use the I FEEL function, and the () icon will be displayed. The unit will sense room temperature at the remote controller instead of at the indoor unit. It then adjusts airflow and temperature accordingly for the ultimate in personal comfort control and energy savings. Press the button again to exit this function. For best performance, keep remote controller away from heat or cold temperature sources while using this function.



I Feel Mode Display

LIGHT BUTTON

Press this button to turn off display light on indoor unit. Press again to turn it back on.

WiFi BUTTON

Press and hold this button for three seconds to turn WiFi function on or off. See "Operation of Smart Control" section for more information.

OPERATION OF WIRELESS REMOTE CONTROLLER

X-FAN MODE

When operating in humid areas, the unit has a **DRY COIL** function called X-Fan that will allow the indoor fan to run for a pre-determined amount of time after the unit is turned off (cooling or dry modes) to ensure that additional moisture is removed from coil. Push the "X-FAN" button to enable this feature. The **X-FAN**  icon will be displayed on remote controller. To deactivate this feature, push the "X-FAN" button again.

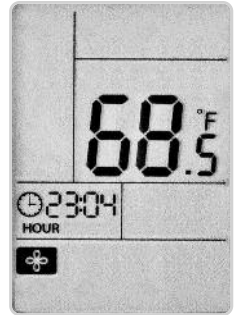

X-Fan Mode Display

DISPLAYING SETPOINT ON FRONT PANEL

Only the setpoint temperature will be displayed on the front panel and on the remote controller.

TIMER SETTING

T-ON button (Timer ON)

To set when you want the unit to turn On at the end of a selected time period, use the button labeled "T-ON" on the remote controller. Press this button to make the clock icon disappear, replaced with the word "ON" (blinking). Press "+" or "-" buttons to adjust timer setting 1 minute at a time. Press and hold "+" or "-" button to set timer more quickly. Press "T-ON" button again to confirm setting, and the word "ON" will stop blinking. To cancel, press "T-ON" button again.

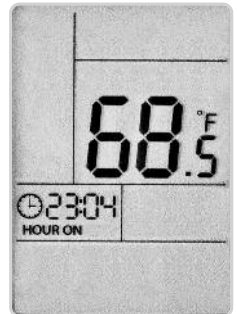

Timer ON Display

OPERATION OF WIRELESS REMOTE CONTROLLER

TIMER SETTING

T-OFF button (Timer OFF)

To set when you want the unit to turn Off at the end of a selected time period, use the button labeled "T-OFF" on the remote controller. Press this button to make the clock icon disappear, replaced with the word "OFF" (blinking). Adjust settings the same as with "T-ON" settings.

NOTE: Under Timer On and Off status, you can set T-ON and T-OFF simultaneously. Before setting timer, be sure to set clock to correct time.



Timer OFF Display

CLOCK SETTING

Press this button to set clock time. "⌚" icon on remote controller will blink. Within 5 seconds, press "+" or "-" button to set clock time. With each pressing of "+" or "-" buttons, clock time will increase or decrease 1 minute. To quickly adjust time setting, press and hold "+" or "-" button for 2 seconds. Release button when you have reached the desired time setting. Press "CLOCK" button to confirm the time, and "⌚" icon will stop blinking.

NOTE: Clock time adopts 24-hour mode. A 12-hour format is not available.



Clock Setting Display

FAN BUTTON

Press the FAN button to adjust the fan circulation indoor speed: Low (■), Low-Medium (■■), Medium (■■■), Medium-High (■■■■), High (■■■■■), Auto and Quiet (🔊).



Fan Display

OPERATION OF WIRELESS REMOTE CONTROLLER

CHANGING BATTERIES AND ADDITIONAL NOTES

To change batteries, slide cover off battery compartment on back of remote controller. Remove and safely discard old batteries. Insert two new AAA 1.5V dry batteries, using correct polarity. Reattach back cover.

NOTE:

- If the remote controller will not be used for a long time, remove batteries to prevent leakage damage.
- Be sure to aim the remote controller at the receiver of the main unit when operating.
- When remote emits a signal, icon will flicker; a tone will be heard when unit receives that signal.

CHANGING BATTERIES

Remove old batteries

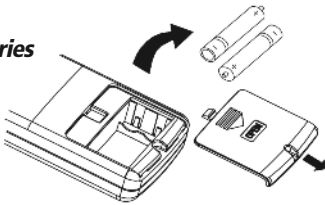

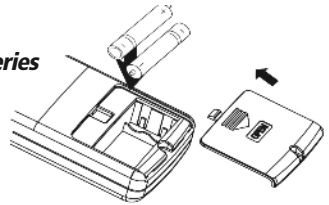

Install new batteries

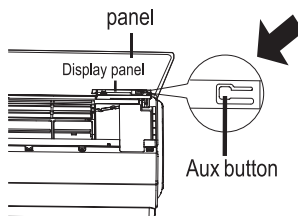

DAMAGED OR LOST REMOTE CONTROLLER

If remote controller is lost or damaged, the Crown system can be turned off directly from the indoor unit. Lift the front panel of the indoor wall unit, then press the AUX button to turn on or turn off. When the unit is on, it will operate in AUTO Mode.



 Warning: Use insulated object to press the auto button

OPERATION OF SMART CONTROL

FOR USE WITH YOUR SMART PHONE

For the ultimate in convenience, your Crown Heat Pump or Air Conditioner features a built-in intelligent WiFi capability and Smart Control function. This allows you to operate the unit through your smart phone. The system is compatible with devices using standard Android or iOS operating systems, and you can connect as many as four separate smart phones. Refer to application program for the specific version.

STEP 1. Download and install Gree-Smart App on your smart phone

METHOD 1: Go to www.gree.com/english/downloadcenter/ihome_jsp_catid_2840.shtml. In the "Download Center," follow instructions to download the "G-Life" Application.

METHOD 2: Scan this QR code and download the application directly.



METHOD 3: Download the "G-Life" Application directly from the Apple App Store (for iOS devices only). After successful installation, the app icon will appear as shown at right:



NOTE: The appearance on your device may vary. Please refer to actual application.

STEP 2. Turn on Indoor Wall Unit WiFi Interface

Using the remote controller, turn On the Crown System (making sure the remote controller is matched). Press and hold the "WiFi" button on the remote controller for at least 5 seconds. WiFi icon  will display when the WiFi function is on.



STEP 3. Connect Crown System to your smart phone/ tablet PC

Enter the WiFi setting of your phone and search for the wireless network named gree-xxxxxxx. For example, gree-E9D1.

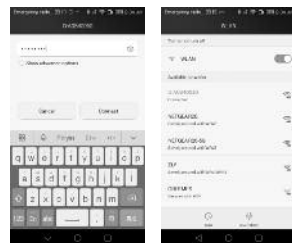

STEP 4. Enter password

Your default password is 12345 or 12345678.

OPERATION OF SMART CONTROL

STEP 5. Get started

Open the application software and click "Refresh."
The system will automatically link with the Crown unit.
Touch "  " to turn On the smart control function.



STEP 6. Set custom network name and password

Slide the bottom function bar to the left.
Select "Settings," then select "Network Setting."
Enter user name and password in the "Login" dialog box (the default user name and password is "admin").
Follow prompts to modify name and password, then click "OK" to finish.
The software app will revert to System Controller screen.

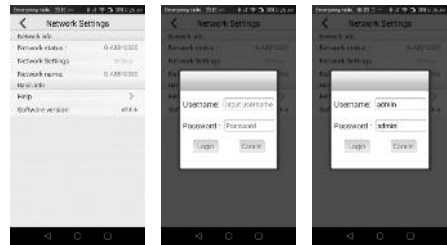

STEP 7. Disconnect from the Network

When you want to exit the app and disconnect from the network, enter your phone's WiFi Setting. Find and select the network you just renamed. Enter password to join – and disconnect from – the network.



STEP 8. Re-connect to the Network

To re-connect to the Crown System network, repeat steps 3, 4 and 5 using your new network name and password.

COMMON NETWORK SETTING PROBLEMS

If local WiFi control fails, check the following items one by one:

- Make sure electrical power is turned on to the outdoor and indoor units.
- Make sure WiFi function is turned On as normal
- Make sure your phone's or tablet's WiFi selects the corresponding Crown Indoor Wall Unit
- Reset with the remote controller and then start setting again from step 3

NOTE: Smart phones or tablets must be used within 25 feet of the Crown Indoor Wall unit.

OPERATION OF SMART CONTROL

TO RESET WiFi MODULE

Turn Crown unit Off with the remote controller and disconnect power to the unit. Re-connect power, wait one minute, then press "WiFi" and "Mode" buttons simultaneously. When the Crown unit emits a beep sound, WiFi module is successfully reset.

NOTE: "WiFi", and Mode buttons must be pressed within two minutes, or you will need to repeat the process.

SMART CONTROL FUNCTIONS

Mode: Select "Auto", "Cool", "Dry", "Fan" or "Heat."
See Remote Controller instructions for detailed operation of these modes.

Fahrenheit °F/Celsius °C Display:
The smart phone app will initialize to display temperatures in °C. To switch the display to °F, turn the Crown unit "ON" with the ON/OFF button and then select "COOL" mode. Press and hold the °C on the smart phone display for 3 seconds. Repeat the procedure to switch the display back to °C.

Temperature: Room temperature setting can be selected by scrolling to the desired room temperature icon.

Fan Speed: Fan Speed can be adjusted by selecting the fan icon and then selecting the speed. See Remote Controller instructions for detailed operation.

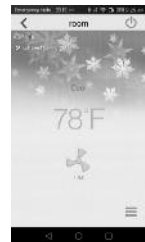

OPERATION OF SMART CONTROL

SOFTWARE FUNCTIONS

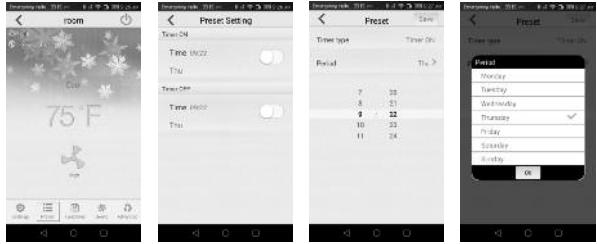

Timer On/Off: Set the Timer On or Off function by selecting the Preset icon. Then move the slider to the right to select either Timer On or Off. Scroll to the desired time period and press Save. See Remote Controller instructions for more details.

NOTE: In Settings interface, you can turn On or Off the various functions and control settings for the various modes. See Remote Controller instructions for details.

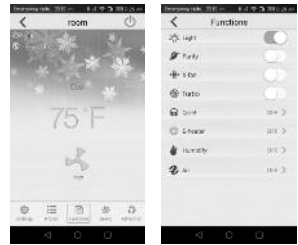

Swing Louvers: This allows you to adjust up/down and left/right swing. Adjust Swing Louvers by selecting the Swing icon. Then select the desired swing louvers positions.



Sleep Mode: Set Sleep Mode by selecting the Advanced icon.

Sleep Curve: This includes DIY mode, Traditional mode, Expert mode and Siesta mode. Under DIY mode, you can set temperature and time. Sleep modes cannot be used with Auto mode or Fan Only mode. See Remote Controller instructions for detailed operation of the Sleep modes.



OPERATION OF SMART CONTROL

Regional Swing: Press "Air flow position" button to adjust the fan coverage of a specific room area. Control this by moving the air conditioner icon left or right. You can then move the person icon among nine pane areas. The Regional Swing function can be turned off through up/down swing. (Up/down swing is only operational in cooling and heating modes.) There is also an "Avoid People" function, which can be turned on or off as desired.

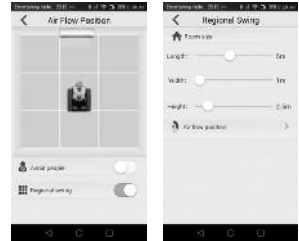

Noise Function: This will control the sound level of the indoor unit. Select "Noise" to enter the Noise setup screen. Set the desired noise level in Cooling. Then select the desired noise level in Heating. The Crown System will automatically adjust fan speed according to the selected noise setting.



Power Saving: In this mode, the unit will automatically detect indoor and outdoor temperatures, and will adjust frequency, fan speed and temperature for maximum energy savings. Use the slider to activate "Power Saving" Mode.



TROUBLESHOOTING

PROBLEM	CAUSE/SOLUTION
System does not restart.	<p>Cause: The system has a built-in three-minute delay to prevent short and/or rapid cycling of the compressor.</p> <p>Solution: Wait three minutes for the protection delay to expire.</p>
Indoor unit emits unpleasant odor when started	<p>Cause: Typically unpleasant odors are the result of mold or mildew forming on the coil surfaces or the air filter.</p> <p>Solution: Wash indoor air filter in warm water with mild cleaner. If odors persist, contact a qualified service professional to clean the coil surfaces.</p>
You hear a “water flowing” sound.	<p>Cause: It is normal for the system to make “water flowing” or “gurgling” sounds from refrigerant pressures equalizing when the compressor starts and stops</p> <p>Solution: The noises should discontinue as the refrigerant system equalizes after two or three minutes.</p>
A thin fog or vapor coming out of the indoor unit when system is running.	<p>Cause: It is normal for the system to emit a slight fog or water vapor when cooling extremely humid warm air.</p> <p>Solution: The fog or water vapor will disappear as the system cools and dehumidifies the room space.</p>
You hear a slight cracking sound when the system stops or starts.	<p>Cause: It is normal for the system to make “slight cracking” sounds from parts expanding and contracting during system starts and stops.</p> <p>Solution: The noises will discontinue as temperature equalizes after 2 or 3 minutes.</p>
The system will not run.	<p>Cause: There are a number of situations that will prevent the system from running.</p> <p>Solution: Check for the following:</p> <ul style="list-style-type: none"> • Circuit breaker is “tripped” or “turned off.” • Power button of remote is not turned on. • Batteries in the remote controller are low. • Remote controller is in sleep mode or timer mode. • Otherwise, contact a qualified service professional for assistance.
The unit is not heating or cooling adequately.	<p>Cause: There are a number of reasons for inadequate cooling or heating.</p> <p>Solution: Check the following:</p> <ul style="list-style-type: none"> • Remove obstructions blocking airflow into the room. • Clean dirty or blocked air filter that is restricting airflow into the system. • Seal around door or windows to prevent air infiltration into the room. • Relocate or remove heat sources from the room.
Water leakage from the outdoor unit.	<p>Cause: It is normal for the outdoor unit to generate condensate water in the reverse cycle heating and defrost mode.</p> <p>Solution: This is normal. No action is required.</p>

TROUBLESHOOTING

PROBLEM	CAUSE/SOLUTION
<p>Water leaking from the indoor unit into the room.</p>	<p>Cause: While it is normal for the system to generate condensate water in cooling mode, it is designed to drain this water via a condensate drain system to a safe location.</p> <p>Solution: If water is leaking into the room, it may indicate one of the following.</p> <ul style="list-style-type: none"> • The indoor unit is not level right to left. Level indoor unit. • The condensate drain pipe is restricted or plugged. All restrictions must be removed to allow continuous drainage by gravity. • If problem persists, contact a qualified service professional for assistance.
<p>Wireless remote controller does not work.</p>	<p>Cause: There are a number of possible reasons</p> <p>Solution: Check the following:</p> <ul style="list-style-type: none"> • The batteries might be low. Change the batteries. • The remote controller must be within 25 ft. (7.5 m) with no obstructions of the indoor unit. If remote controller needs to be replaced, contact a qualified service professional for assistance. In the meantime, use the Aux Button to operate the system.
<p>The unit will not deliver air.</p>	<p>Cause: There are a number of system functions that will prevent air flow.</p> <p>Solution: Check for the following:</p> <ul style="list-style-type: none"> • In heating mode, the indoor fan may not start for three minutes if the room temperature is very low. This is to prevent blowing cold air. • In heat mode, if the outdoor temperature is low and humidity is high, the system may need to defrost for up to 10 minutes before beginning a heating cycle. • In dry mode, the indoor fan may stop for up to three minutes during the compressor off delay. • Otherwise, you should contact a qualified service professional for assistance.
<p>Moisture or condensation on the discharge air louvers or outlet vents.</p>	<p>Cause: It is normal for the system to develop condensation or moisture on the discharge air louvers when cooling warm humid air for a long period of time.</p> <p>Solution: The condensation or moisture will disappear as the system cools and dehumidifies the room space.</p>

CAUTION

Stop operation and call for service in the following circumstances:

- You hear a harsh or unusual sound during operation.
- Unusually foul odor is emitted during operation.
- Water is leaking in the room.
- You notice a burning smell or see smoke.
- Circuit breaker trips frequently, or unit stops abnormally often.

CARE AND CLEANING

WARNING

Take notice of the following items before cleaning your Crown indoor wall unit.

- To avoid electric shock or injury, do not attempt to clean the unit unless it has been turned off and the indoor and outdoor units have been disconnected from the main power supply.
- Do not wash the unit with water; this may cause an electric shock.
- During cleaning, be sure to use a stable and safe standing platform.

FRONT PANEL CLEANING

Wash the front panel using warm water and mild detergent with a soft cloth or soft brush.

NOTE: Do not use bleach, abrasives or water above 110°F (45°C) as it may cause discoloration or damage to the surface of the unit.

AIR FILTER CLEANING

Changing your air filter on a regular basis prevents many problems. Dirty air filters will affect the performance and the longevity of your unit. It is recommended that air filters be cleaned every three (3) months.

To access and clean the filter:

1. Open Front Panel

Firmly grasp both sides of the front panel and pull upward to about 60 degree angle. (NOTE: do not force panel open).



2. Remove Filter

Remove the filter as indicated in the figure at right.



3. Clean Filter

Use vacuum to clean the filter.

When the filter is very dirty, use warm water (below 110°F) to clean it, and then dry filter before replacing.

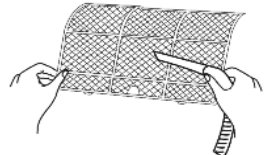

4. Reinstall Filter

Reinstall the filter and then close the panel cover tightly.

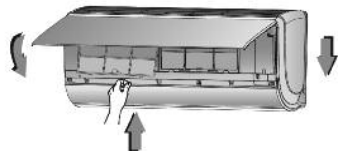

ENERGY SAVING TIPS

- 1. Reduce room setpoint at night:** During the nighttime hours you don't require the same level of conscious cooling or heating. Try using Sleep Mode to gradually relax room temperature and allow the unit to run less and save energy.
- 2. Curtains and shades:** In the summer, it is recommended to block the effects of the sun. Close window curtains and shades on the south and west side of your home to help block solar heat. In winter, the sun is your friend. Open curtains and shades to allow solar heat into your room.
- 3. Close doors:** If you don't need to heat and cool your whole home, confine the heating and cooling to one room by closing doors.
- 4. Service the unit:** Some basic maintenance might be all you need. The outdoor unit will greatly benefit from a good hosing off, especially in treed areas where seeds and other debris can stick to coil fins and make the unit work up to 15% harder!
- 5. Rearrange the room:** Furniture that obstructs airflow means you could be heating and cooling the back of a chair instead of the actual living space. Remove or rearrange obstacles blocking airflow.
- 6. Try 75 degrees:** 75°F is a good point for an air conditioner to run at its optimal performance level. Even a 5-degree change in temperature can make your unit use up to 40% more energy.
- 7. Lighting:** Turning lights off can help reduce your heat. Each light bulb is a tiny heater. Your air conditioner must waste energy overcoming the heat from your lights to reach and hold your desired room temperature.
- 8. Is anyone home?** If possible, while you're away turn your unit to Auto mode and make sure windows and curtains are closed. Although room temperature may be less than optimal for a few minutes when you return, the unit will soon have the room back to your desired temperature.
- 9. Don't forget the fan:** The fan is much like a car. The faster it runs, the more energy it uses. Sometimes we need the car to go fast, but slow is good enough most of the time. Try saving money by using the comfortable quiet low fan speed as much as possible.



GREE ELECTRIC APPLIANCES, INC.

www.greecomfort.com



LIMITED WARRANTY

GREE distributor (hereinafter "Company") warrants this product against failure due to defect in materials or workmanship under normal use and maintenance as follows. All warranty periods begin on the date of original installation. If the date cannot be verified, the warranty period begins one hundred twenty (120) days from date of manufacture. If a part fails due to defect during the applicable warranty period Company will provide a new or remanufactured part, at Company's option, to replace the failed defective part at no charge for the part. This limited warranty is subject to all provisions, conditions, limitations and exclusions listed below.

- Seven (7) years on compressor and Five (5) years on all parts to the original registered end-user.
- One (1) year warranty on remote controller unit.
- Proper installation – Limited warranty applies only to systems that are installed by a state certified or licensed HVAC contractor, under applicable local and state law in accordance with all applicable building codes and permits; GREE installation and operation instructions and good trade practices.
- Warranty applies only to products remaining in their original installation location.
- Defective parts must be returned to the distributor through a registered servicing dealer for credit.

LIMITATIONS OF WARRANTIES: ALL IMPLIED WARRANTIES AND/OR CONDITIONS (INCLUDING IMPLIED WARRANTIES OR CONDITIONS OF MERCHANTABILITY AND FITNESS FOR A PARTICULAR USE OR PURPOSE) ARE LIMITED TO THE DURATION OF THIS LIMITED WARRANTY, SOME STATES OR PROVINCES DO NOT ALLOW LIMITATIONS ON HOW LONG AN IMPLIED WARRANTY OR CONDITION LASTS, SO THE ABOVE MAY NOT APPLY TO YOU. THE EXPRESS WARRANTIES MADE IN THIS WARRANTY ARE EXCLUSIVE AND MAY NOT BE ALTERED, ENLARGED, OR CHANGED BY ANY DISTRIBUTOR, DEALER, OR OTHER PERSON, WHATSOEVER.

THIS WARRANTY DOES NOT COVER:

1. Labor or other costs incurred for diagnosing, repairing, removing, installing, shipping, servicing or handling of either defective parts, or replacement parts, or new units.
2. Normal maintenance as outlined in the installation and servicing instructions or Owner's Manual, including filter cleaning and/or replacement and lubrication.
3. Failure, damage or repairs due to faulty installation, misapplication, abuse, improper servicing, unauthorized alteration or improper operation.
4. Failure to start due to voltage conditions, blown fuses, open circuit breakers, or damages due to the inadequacy or interruption of electrical service.
5. Failure or damage due to floods, winds, fires, lightning, accidents, corrosive environments (rust, etc.) or other conditions beyond the control of the Company.
6. Parts not supplied or designated by Company, or damages resulting from their use.
7. Products installed outside USA and Canada.
8. Electricity or fuel costs, or increases in electricity or fuel costs from any reason whatsoever, including additional or unusual use of supplemental electric heat.
9. Any cost to replace, refill or dispose of refrigerant, including the cost of refrigerant.
10. Any special, indirect or consequential property or commercial damage of any nature whatsoever. Some states or provinces do not allow the exclusion of incidental or consequential damages, so the above limitation may not apply to you.

For additional warranty exclusions, visit www.GreeComfort.com.

This warranty gives you specific legal rights, and you may also have other rights which vary from state to state or province to province.

For warranty service or repair, contact your installing contractor. You may find the installer's name on the equipment or in your Owner's packet.

Complete product registration below and send back by e-mail at service@twclimate.com

PRODUCT REGISTRATION

Model No. _____

Serial No. _____ Date of Installation _____

Owner Name _____

Address of Installation _____

Installing Contractor _____

Address _____

Phone No. / E-mail _____