



evō

HIGH-WALL DUCTLESS AIR CONDITIONING & HEATING SYSTEM

OWNER'S MANUAL

Models:

GWH09AB-A3DNA1B

GWH12AB-A3DNA1B

GWH12AB-D3DNA1B

GWH18AB-D3DNA1B

GWH24AB-D3DNA1B

Thank you for selecting GREE evō High Wall Ductless Air Conditioner and Heating System. Please read this manual carefully before operation and keep it for further reference.

For more information, please visit our website at www.greecooling.com.



Table of Contents

Notices for operation.....	3	Installation service.....	15
Typical operation.....	5	Installation dimension diagram.....	16
Identifying major components.....	6	Installing the indoor unit.....	17
Wireless remote control operation.....	7	Installing the outdoor unit.....	19
Emergency operation.....	10	After installation and testing.....	20
Cleaning and caring for your unit.....	11	Circuit diagrams.....	20
Troubleshooting.....	12	Warranty.....	22

NOTE: Figures in this manual may differ from the appearance of the actual unit. Refer to the system itself or contact a qualified service professional for further information.

Recognize safety information. This is the safety-alert symbol . When you see this symbol on the unit and in instructions or manuals, be alert to the potential for personal injury. Understand these signal words: DANGER, WARNING, and CAUTION. These words are used with the safety-alert symbol. DANGER identifies the most serious hazards which will result in severe personal injury or death.



WARNING signifies hazards which could result in personal injury or death.



CAUTION is used to identify unsafe practices which may result in minor personal injury or product and property damage.



NOTE is used to highlight suggestions which will result in enhanced installation, reliability, or operation.

NOTICES FOR OPERATION

IMPORTANT OPERATING INFORMATION PLEASE READ CAREFULLY BEFORE OPERATING THE UNIT.

⚠ WARNING

Disconnect unit from power source when it will not be in use for long periods of time. Dust can accumulate in the unit, which could be a fire hazard.

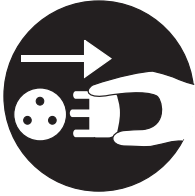

⚠ WARNING

Do not splice the power cord or use an extension cord. Overheating can occur, causing a fire hazard.

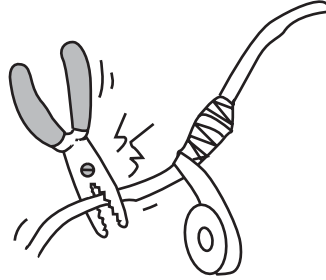

⚠ WARNING

If you smell or see smoke, turn unit off and immediately contact a qualified service professional.

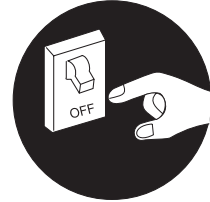

⚠ WARNING

Keep combustible materials away from the unit.

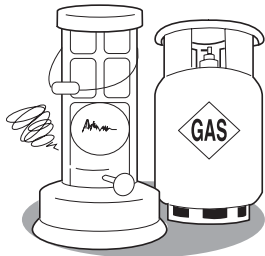

⚠ WARNING

Do not attempt to install, relocate or repair the unit yourself. Contact a qualified service professional.

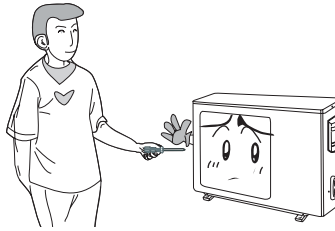

⚠ WARNING

Do not cut or damage power and/or controls wires. In case of damage, immediately contact a qualified service professional.

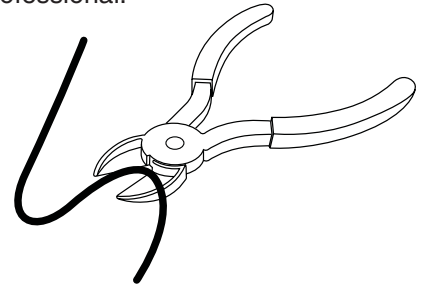

⚠ WARNING

Keep away from water. Do not clean unit with water. This can cause electric shock.

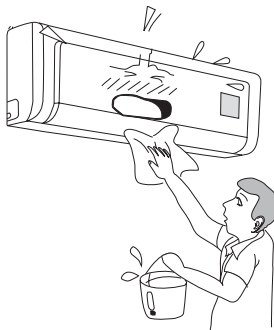

⚠ CAUTION

Do not insert your hands or any other device into the air intake or outlet vents.

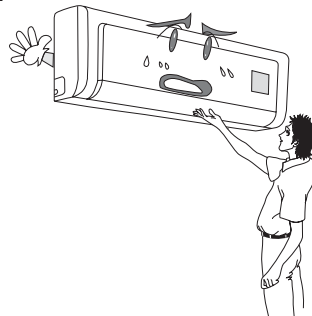

⚠ NOTE

Keep windows and doors closed while operating unit to save on electricity cost.

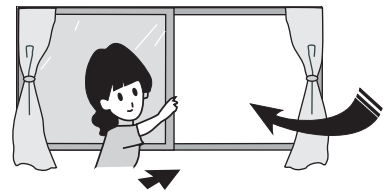

NOTICES FOR OPERATION

IMPORTANT OPERATING INFORMATION PLEASE READ CAREFULLY BEFORE OPERATING THE UNIT.

⚠ NOTE
Adjust vertical or lateral airflow using the remote control.

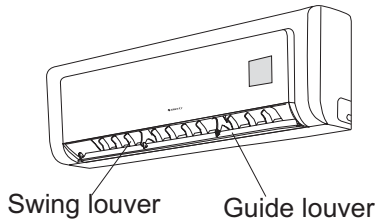

⚠ NOTE
Do not block air intake or outlet vents on either indoor or outdoor components. Doing so may cause a malfunction of the unit.

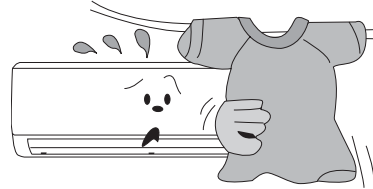

⚠ NOTE
Do not direct the air toward animals or plants.

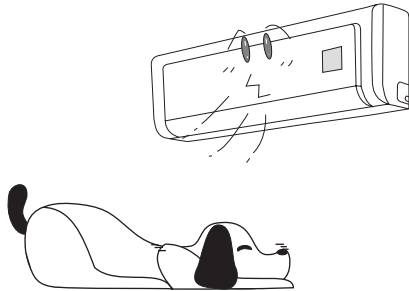

⚠ NOTE
Do not allow cold air to directly blow on any person for a prolonged time. This can cause discomfort and worsen health problems.

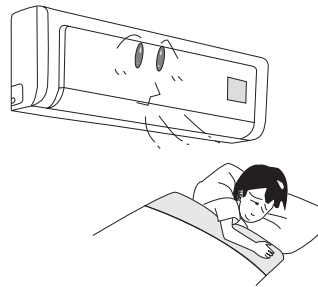

⚠ NOTE
Do not use the unit to chill drinks, preserving food or drying clothes.

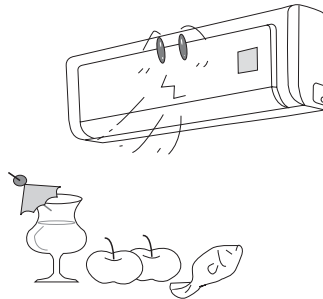

⚠ NOTE
After the unit has been professionally installed, choose a thermostat setting that is comfortable for all household members. Do not repeatedly or rapidly turn the unit on and off as this can cause malfunctions.

⚠ NOTE
Keep space heaters and cooking units away from air conditioner.

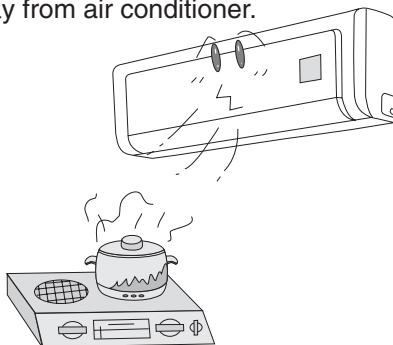

TYPICAL OPERATION

How your EVO unit works in cooling

In cooling mode, your EVO indoor unit will absorb heat from the room, then the EVO outdoor unit will discharge the heat to the outdoors. The EVO's cooling capacity decreases as the outdoor temperature increases. This causes the EVO to work harder and longer to hold the selected room temperature. Your evo unit will operate in cooling down to 41°F (5°C)

Indoor Coil Freeze Protection

- Frost may form on the indoor coil during cooling operations when the outdoor temperature below 50°F (10°C). Prolong operation may cause ice to form on the indoor coil and block airflow. If the EVO indoor unit microcomputer detects ice on the indoor coil it will stop the compressor to defrost the coil and protect the unit.

How your EVO unit works in heating

In heating mode, your EVO outdoor unit will absorb heat from the outdoor ambient, then the EVO indoor unit will discharge the heat to the room. The EVO's heating capacity decreases as the outdoor temperature decreases. Your evo unit will heat down to 5°F (-15°C).

During extreme cold outdoor temperatures, you may need an additional heating source to supplement the EVO heating output.

Defrost Function

- In heating mode, frost may form on the outdoor coil during humid and low outdoor temperature conditions. Prolong operation may cause ice to form on the outdoor coil and block airflow. This will reduce the EVO's heating capacity. If the EVO microcomputer detects ice on the outdoor coil, it will switch automatically to defrost mode to melt the ice and clear the coil. During defrost mode, heating will be discontinued and the EVO indoor unit will flash the Defrost indicator. The compressor will continue to run while indoor and outdoor fans will stop. It is normal to see steam or vapor coming from the outdoor unit during defrost mode. Defrost mode will terminate 12 minutes after initiation of defrost cycle or when the outdoor coil temperature is 50°F (10°C) or greater.

IDENTIFYING MAJOR COMPONENTS

Indoor unit

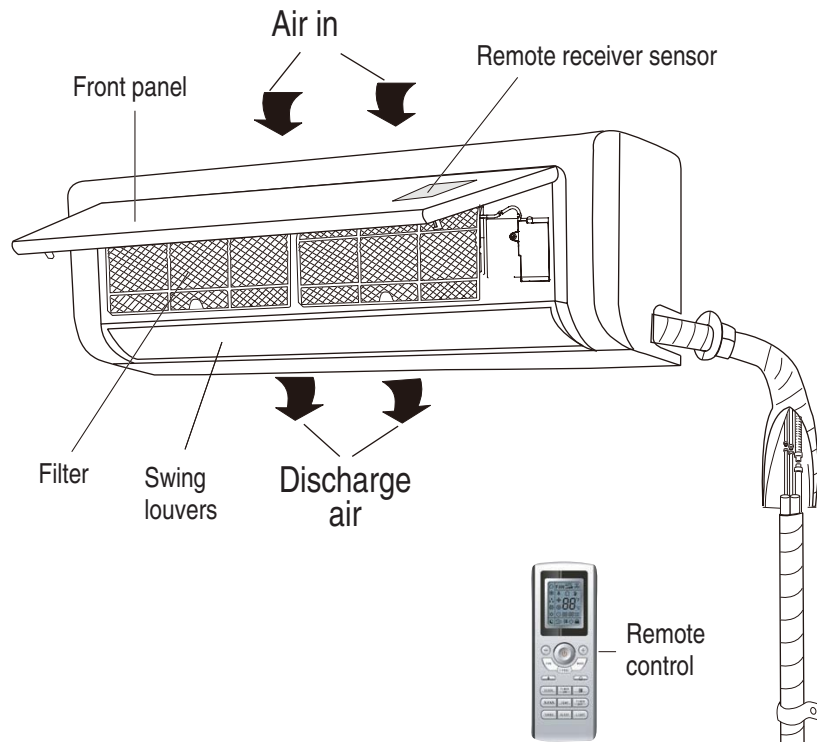

Outdoor unit

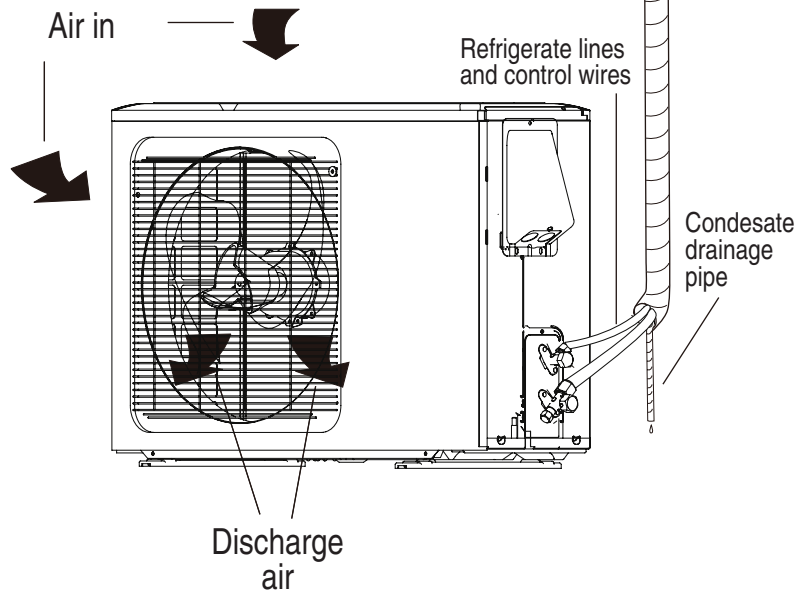

WIRELESS REMOTE CONTROL OPERATION

Names and Functions of Remote Control Buttons

Signal Transmitter



Remote Control

ON/OFF button

Press once to turn on unit. Press again to turn off unit. Using the ON/OFF function will cancel TIMER and SLEEP functions, but preset times will not be affected.

MODE **MODE button**

Set AUTO, COOL, DRY, FAN, or HEAT sequentially. In Auto Mode, room temperature is not displayed.

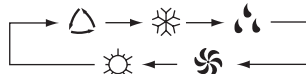

-  **AUTO**
-  **COOL**
-  **DRY**
-  **FAN**
-  **HEAT**

(Only for cooling and heating unit.)

NOTE: On power up, unit will default to AUTO Mode. Initial room setting is 77°F (25°C), except in HEAT Mode the initial setting is 82°F (28°C).



SLEEP button

Press this button to select SLEEP ON or SLEEP OFF. This function must be set after the unit is powered on. It will not function under AUTO or FAN modes.

FAN **FAN button**

Select Low, Medium or High in Auto mode for default fan speed. In DRY mode, only low fan speed can be selected.



 **Low fan**

 **Medium fan**

 **High fan**



CLOCK button

Press the button, and clock icon will flash. Within 5 seconds, set the time by pressing + or – buttons to set hours and minutes. Press button again to save time setting. Note that this is the current time, not the timer setting.

LIGHT **LIGHT button**

Press the LIGHT button and the indoor unit display turns ON. Press again, the indoor unit display turns OFF.



TURBO button

In COOL or HEAT mode, use this button to turn TURBO function on or off. The TURBO icon will appear in the display when the function is on. When changing modes or fan speeds, the function will be canceled.

NOTE: Be sure there are no obstructions between remote control and the EVO Indoor unit (receiver sensor)

- Do not drop or throw the remote control.
- Do not submerge remote control in water.
- Do not leave in direct sunlight.
- Do not leave near heat source.

WIRELESS REMOTE CONTROL OPERATION

Names and Functions of Remote Control Buttons

NOTE: Not every unit has each of the functions described below. If your unit does not come equipped with a certain function, the button will be inactive.



Remote Control



X-FAN button

Pressing the X-FAN button in COOL or DRY mode will keep the fan running for 10 minutes to dry the indoor unit. After drying, X-FAN OFF is defaulted. This function is not available in AUTO FAN or HEAT modes.

- Button

Use this button to decrease temperature in HEAT or COOL modes. Press button for 2 seconds to activate.

+ Button

Use to increase temperature settings in HEAT or COOL mode.

NOTE: In heat, cool, and dry mode, the room temperature setting will be displayed.

In AUTO mode, the temperature display is off and the + and - Buttons are not used.



SWING UP and DOWN BUTTON

Use this function to control direction of air circulation. Select from five louver positions available by pressing the button. When the guide louver begins to swing up or down, it turns off the SWING function and the icon will appear as the louver position is readjusting.

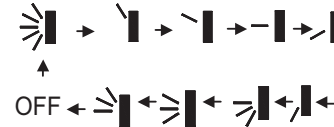

TIMER ON

TIMER ON button

When TIMER function is activated, the (clock icon) will blink and numerical display becomes the timer readout. Press the + or – button to adjust time. Every press of the + or – keys adjusts time by 1 minute. Within 5 seconds of setting the timer, press the TIMER ON button to set the timer. Please check the clock setting for accuracy after setting timer.

TIMER OFF

TIMER OFF button

To cancel TIMER settings, press TIMER OFF button. Clock icon will blink, and settings will be canceled.



I FEEL button

Press this button to activate I FEEL. When I FEEL is active, the evo unit will use the room temperature measured by the remote control.



TEMP button

This function not available.



Air button

This function not available.



Health button

This function not available.

WIRELESS REMOTE CONTROL OPERATION

Getting Started:

1. When the unit is powered on, press ON/OFF button to start unit.
(**NOTE:** When unit is powered on, the guide louver of the main unit will close automatically.)
2. Press MODE button and select desired running mode.
3. Press + or – button to set desired temperature. This step is not necessary in AUTO mode.
4. Press FAN button to set fan speed: Low, Middle, High or Auto.
5. Press  to set the louver position or swing.

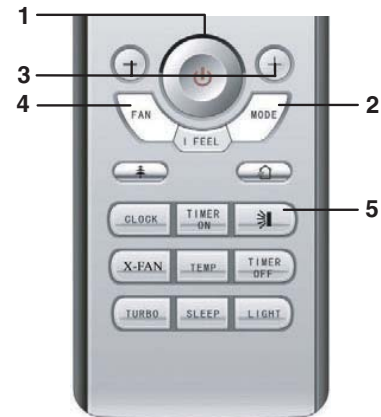

Optional Settings:

1. Press SLEEP button to set sleep.
2. Use TIMER ON and TIMER OFF buttons to set timer.
3. Press LIGHT button to illuminate display on the indoor unit. (Not available on all units.)
4. Press TURBO ON or OFF to set Turbo function.



evo Features

X-FAN MODE

This mode forces the indoor fan to continue running for 10 minutes after each cooling cycle to dry off the indoor evaporator coil which helps to inhibit the growth of mold and mildew.

TURBO MODE

This mode boost the cooling or heating air flow allowing the system to reach preset room temperature in the shortest amount of time.

AUTO RUN MODE

In AUTO mode, the system will automatically maintain a room temperature between 64°F (17.8°C) and 77°F (25°C). If the room temp is above 77°F (25°C) the system will operate in COOL mode. If the room temp is below 64°F (17.8°C) the system will operate in HEAT mode. If the room temp is less than 77°F (25°C) and more than 64°F (17.8°C) the system will be idle and the fan will run to circulate and filter air. In this mode the set room temperature will not be displayed on the remote. AUTO mode is the default setting for the initial power on cycle.

SLEEP MODE

This mode is used to conserve energy. The system can be programmed through the remote control to turn off after a selected run time period. Sleep mode can be used when the system is in COOL, HEAT or AUTO mode.

DEHUMIDIFICATION (DRY) MODE

In dehumidification mode, the system dries, filters and slightly cools room air temperature. Use of this mode does not take the place of a dehumidifier.

SWING MODE

In this mode, the discharge air louvers can be positioned for convenient airflow into the room. The discharge air louvers will step one position at a time until the desired position is selected.

LOCKING REMOTE CONTROL

In this mode, the remote control can be locked to prevent system changes. To lock the remote control, press + and - buttons simultaneously for 2 seconds. The lock icon will flash three times and stay on signaling the remote control is locked. To unlock the remote control, press + and - buttons simultaneously for 2 seconds until the lock icon disappears.

TEMPERATURE DISPLAY

This mode allow you to select the system temperature displays in either degree F or degree C. Simultaneously hold the MODE and (-) minus buttons to toggle between degree F and degree C.

WIRELESS REMOTE CONTROL OPERATION

Replacing Batteries

1. Find the battery cover on back of unit (see figure). Depress the arrow, and slide battery case open.
2. Remove old batteries and replace with two new AAA 1.5 V batteries. Place batteries in positions indicated.
3. Slide battery case cover back into place.
4. Attach the back cover of wireless remote control. (As shown in figure.)

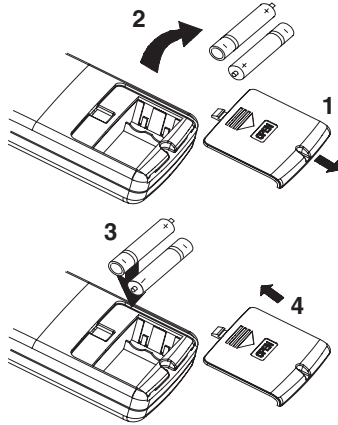

NOTES:

- Always use all new batteries.
- If remote control will not be used for an extended period of time, remove batteries to prevent leakage and damage to unit.
- Make sure unit is in receiving range.
- Do not operate near television set or stereo or other device that uses remote control.
- If wireless remote control does not operate normally after batteries have been changed, remove the batteries and wait 30 seconds. Replace batteries and test unit again. If it still does not operate correctly, replace batteries.
- The remote control can operate the unit from a distance of up to 25 ft (7.6 m) as long as there are no obstructions.

EMERGENCY OPERATION

If the wireless remote control unit is lost or damaged, use THE MANUAL OVERRIDE SWITCH to operate the unit. Manual operation means the unit is operating in AUTO mode. In AUTO mode, the system will automatically maintain a room temperature between 64°F (17.8°C) and 77°F (25°C). If the room temp is above 77°F (25°C) the system will operate in COOL mode. If the room temp is below 64°F (17.8°C) the system will operate in HEAT mode. If the room temp is less than 77°F (25°C) and more than 64°F (17.8°C) the system will be idle and the fan will run to circulate and filter air.

Manual Override Operation:

- To activate Manual Override mode, press the Auto/Stop button located under the front cover of the indoor unit. (See figure below). In Manual Override mode, the system will not respond to commands from the remote control.
- To turn Manual Override Mode off, press the Auto/Stop button again. Once off, the system will respond to the remote control.

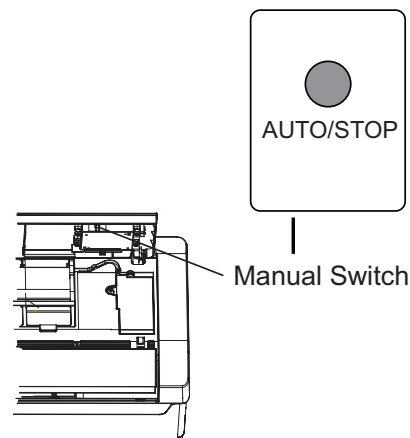

CLEANING AND CARING FOR YOUR UNIT

⚠ CAUTION

- Turn off power and disconnect unit from power source before cleaning. Failure to do so could cause electric shock.
- Never spray water on either indoor or outdoor unit. This could cause damage or unit failure.
- Never use abrasive cleaners on indoor or outdoor unit. Use only slightly damp clean, soft cloth or very mild cleansers.

Cleaning the Front Panel

1. Remove front panel for cleaning.
Using the figure at right as a guide, lift panel up and pull out.

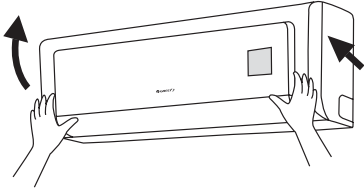

2. Wash the panel.
Wash with water, soft cloth or soft brush. Use only very mild cleaners. Then dry completely.

NOTE: Take down the display panel before cleaning. Never use water above 113°F (45°C) because it may cause discoloration or damage to surface.

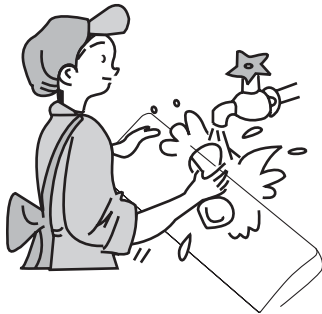

3. Replace front panel.
Fit the sides of the panel into slots as shown and push panel into place.

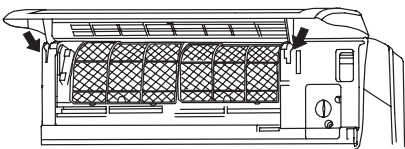

Cleaning the Air Filter

CLEANING IS RECOMMENDED EVERY THREE MONTHS.

NOTE: If the indoor unit is exposed to excessive dust, cleaning may be necessary more often. Use caution when removing the filter to avoid sharp metal extensions.

1. Remove air filter by tilting up the unit cover and pulling filter free.

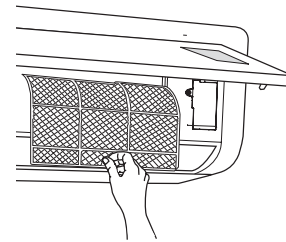
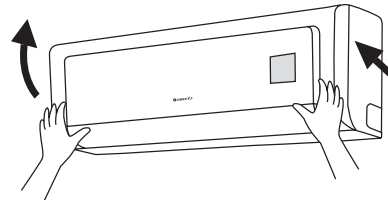

2. Clean air filter using a vacuum or warm water and mild cleaner below 113°F (45°C). Water above 113°F (45°C) can cause discoloration or damage. Air dry filter in the shade. Never use fire to clean stains or debris on filter.

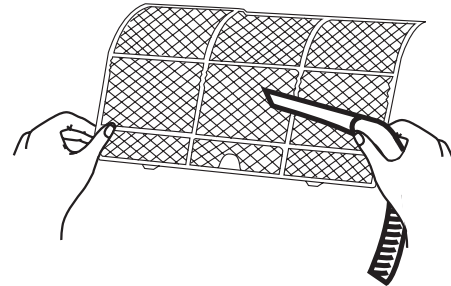

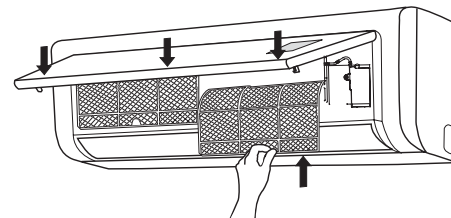

3. Reinsert the filter. See figure below. Align filter along arrows. Then close unit.



TROUBLESHOOTING

⚠ WARNING

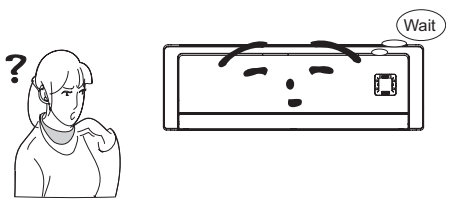
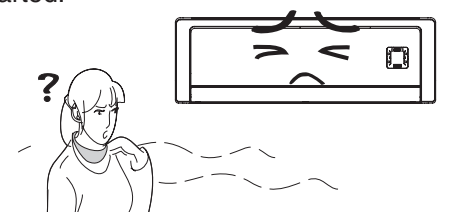
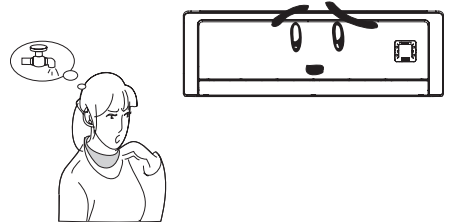
Do not attempt any repairs on the unit yourself. Incorrect repair can cause shock or fire. Always call a qualified service professional. Using these Troubleshooting suggestions can save time when you contact the qualified service professional.

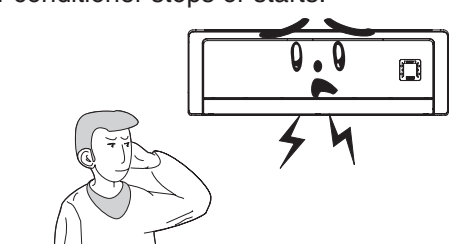
PROBLEM	CAUSE/SOLUTION
<p>Air conditioner does not restart.</p> 	<p>Cause: The evo system has a built in 3 minute delay to prevent short and/or rapid cycling of the compressor.</p> <p>Solution: Wait 3 minutes for the protection delay to expire.</p>
<p>Air conditioner emits unpleasant odor when started.</p> 	<p>Cause: Typically unpleasant odors are the result of mold or mildew forming on the coil surfaces or air filter.</p> <p>Solution: Wash indoor air filter in warm water with mild cleaner. If odors persist, contact a qualified service professional to clean the coil surfaces.</p>
<p>You hear a “water flowing” sound.</p> 	<p>Cause: It is normal for the air conditioning system to make “water flowing” or “Gurgling” sounds from refrigerant pressures equalizing when the compressor starts and stops.</p> <p>Solution: The noises should discontinue as the refrigerant system equalizes after 2 or 3 minutes.</p>
<p>A thin fog or vapor coming out of the unit when air conditioner is running.</p> 	<p>Cause: It is normal for the air conditioning system to emit a slight fog or water vapor when cooling extremely humid warm air.</p> <p>Solution: The fog or water vapor will disappear as the system cools and dehumidifies the room space.</p>
<p>You hear a slight cracking sound when the air conditioner stops or starts.</p> 	<p>Cause: It is normal for the air conditioning system to make “slight cracking” sounds from parts expanding and contracting during system starts and stops.</p> <p>Solution: The noises should discontinue as temperatures equalizes after 2 or 3 minutes.</p>

TROUBLESHOOTING

PROBLEM

CAUSE/SOLUTION

The unit will not run.

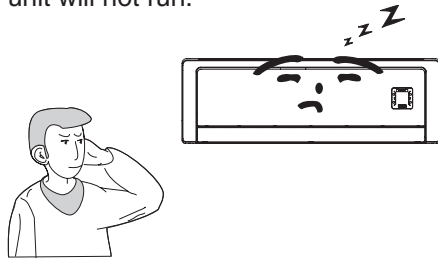

Cause: There are a number of situations that will prevent the system from running.

Solution: Check for the following:

- Circuit Breaker is "tripped or turned Off".
- Power Button of remote is not turned ON.
- Batteries in the remote control are low.
- Remote control is in Sleep mode or Timer mode.
- Otherwise, you should contact a Qualified Service Professional for assistance.

Heating or cooling not running efficiently.

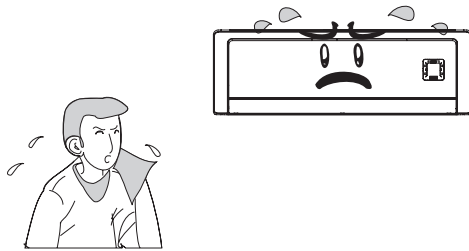

Cause: Your evo system is designed to operate at peak efficiency for years with routine maintenance.

Solution: Check the following reasons for loss of system efficiency:

- Remove obstructions blocking the return or discharge air flow into the room.
- Clean dirty or blocked indoor air filter that is restricting air flow into the system.
- Seal outdoor air leaks in the room space from door or windows.
- Relocate (if possible) other heating sources in the room space.

Wireless remote control lost or does not work.

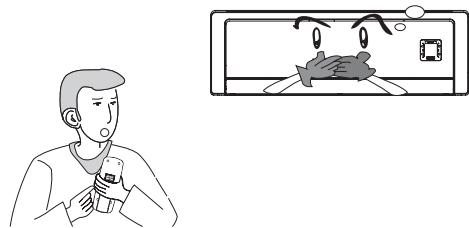

Cause: There are a number of reasons for the remote control not to work.

Solution: Check the following reasons for the remote control not working:

- The batteries might be low, change the batteries.
- The remote control must be within 25 ft (7.6m) with no obstructions of the indoor unit.

If remote control is lost or damaged and need to be replaced, contract your qualified service professional for assists. In the meantime, use the manual Override Mode to operate the evo system.

Water leaking from indoor unit into the room

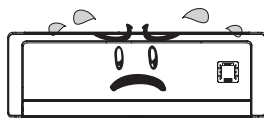

Cause: It is normal for air conditioning system generate condensate water in cooling mode. The evo system is designed to effectively and efficiently collect and safely drain the condensate water from the indoor unit to the outdoors via a condensate drain tube.

Solution: Water leaking into the room indicates:

- The indoor unit is not level right to left. Level indoor unit.
- The condensate drain tube is restricted or plugged. All restricts must be removed to allow continuous gravity force drainage.
- If problem persist, contact a qualified service professional for assistance.

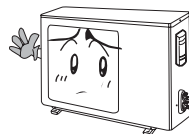

Water leakage in outdoor unit.



Cause: It is normal for outdoor unit to generate condensate water in reverse cycle heating mode and defrost.

Solution: Water leaking from the outdoor unit is normal in reverse cycl heating mode or defrost.

TROUBLESHOOTING

PROBLEM	CAUSE/SOLUTION
<p>The unit will not deliver air.</p> 	<p>Cause: There are a number of system functions that will prevent the indoor fan from running.</p> <p>Solution: Check for the following:</p> <ul style="list-style-type: none">• In heating Mode, the indoor fan may not start for 3 minutes if the room temperature is very low to prevent blowing cold air.• In heat mode, if the outdoor temperature is low and humidity is high the system may need to defrost for up to 12 minutes before beginning a heating cycle.• In Dry Mode, the indoor fan may stop for up to 3 minutes during the compressor off delay.• Otherwise, you should contact a Qualified Service Professional for assistance.
<p>Moisture or condensation on the discharge air louvers or outlet vents.</p> 	<p>Cause: It is normal for air conditioning system to develop condensation or moisture on the discharge air louvers when cooling warm humid air for a long period of time.</p> <p>Solution: The condensation or moisture will disappear as the system cools and dehumidifies the room space.</p>



CAUTION: STOP OPERATION AND CALL FOR SERVICE IN THE FOLLOWING CIRCUMSTANCES:

- You hear a harsh or unusual sound during operation.
- Unusually foul odor is emitted during operation.
- Water is leaking in the room.
- Circuit breaker trips frequently, or unit stops abnormally often.
- Liquid is spilled into unit.

INSTALLATION SERVICE

Important Information About Installation

Installation must be performed by qualified service professional according to codes and information in this manual.

Basic Requirements

Unit must be placed in the proper location. Observe these considerations:

- Avoid areas with strong heat source, vapors, or flammable materials or gases.
- Avoid areas where high frequency radio waves are generated by transmitters, construction equipment or medical equipment.
- Avoid areas where there is excessive salinity in the air.
- Avoid areas where there are oil fumes in the air.
- Avoid areas where sulfurous gas is emitted, such as areas near hot springs.
- Other unusual circumstances as determined by installer.

Indoor Unit Placement Considerations

1. Place where there are no obstructions to airflow.
2. Place where condensing water can be easily removed and unit can be easily connected to outdoor unit.
3. Install out of reach of children.
4. Install on solid surface that can support weight and vibration and not contribute to vibration and noise.
5. Install where there is sufficient space for access in case of need for routine maintenance. Unit should be at least 72 in. (183 cm) off the floor.
6. Install where there is easy access to air filter for cleaning.
7. Observe all local building requirements and codes.

Outdoor Unit Placement Considerations

1. Choose a location where noise and airflow will not disturb neighbors, animals or plants.
2. Choose a location where there is sufficient ventilation.
3. Avoid obstructions to intake or outlet vents.
4. The location must withstand full weight and vibration of unit and permit safe installation.
5. Select a dry location away from direct sunlight and strong winds.
6. Select location with sufficient room for the unit with convenient access for maintenance and repair.
7. Observe all local building requirements and codes.

Important Safety Considerations

1. Use only rated voltage installation and a dedicated circuit.
2. Power source must be grounded. Connection to circuit breaker box must allow for power surge or excessive heat tripping of breaker. Always use a professional electrician to install the unit.
3. Observe all local building requirements and codes

CAUTION:

- Be sure live wires and ground wire are properly connected.
- Incorrect connection could cause fire.

Grounding Requirements

1. The air conditioner is a Type 1 electrical appliance. Follow grounding requirements.
2. The yellow-green wire is the ground wire. Do not use for any other purpose.
3. Grounding should follow local/national codes.
4. Reliable grounding means that the wires should not be connected to water pipe, gas pipe, sewage pipe or any other inappropriate location.

Other Considerations

1. Follow the wiring diagrams affixed to the unit for proper installation.
2. The model and rated value of replacement fuses can be found on the silk-screened information on the fuse sleeve or controller.
3. The unit must be installed in accordance with national wiring requirements.
4. Unit should not be operated by children, or by those with limited physical, mental or sensory capacities unless they are given special, supervised instructions.
5. Children should be supervised to make sure they do not play with the appliance.

INSTALLATION DIMENSION DIAGRAM

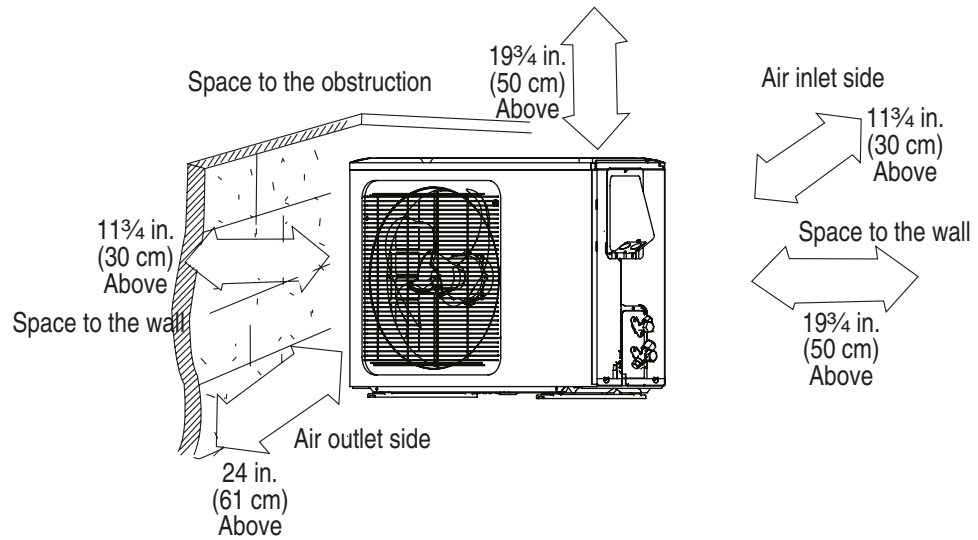
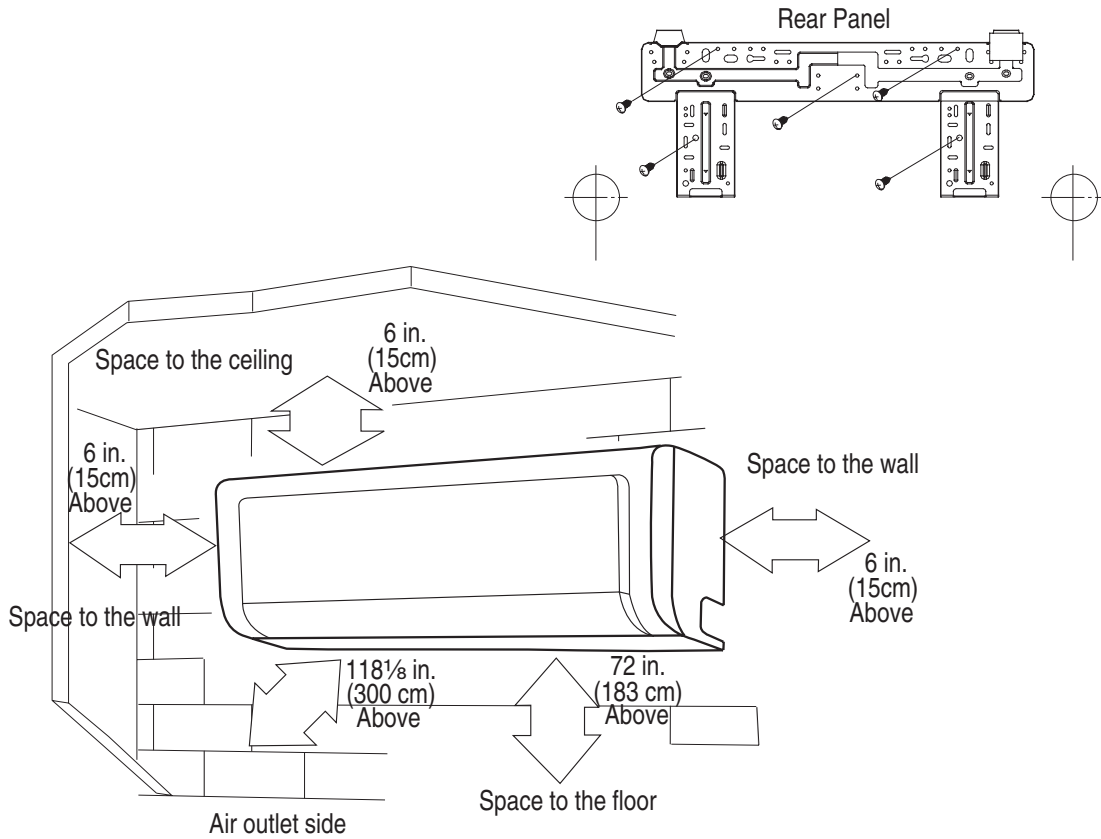

INSTALLING THE INDOOR UNIT

Installing the Rear Panel

1. First find the center of the indoor unit in relation to the rear panel before mounting to the wall. If rear panel is not attached to the indoor unit, place the rear panel on the indoor unit as it will later be attached. Find the center (right to left) of the indoor unit and mark that position on rear panel.
2. Place the rear panel in the desired location on the wall. Always install the rear panel horizontally and level right to left to facilitate condensate water drainage.
3. Attached rear panel to the wall with heavy-duty screws.
4. Rear panel should be solidly attached to the wall, enough to withstand the weight of 132 lbs (60 kg). Weight should be evenly distributed among the screws.

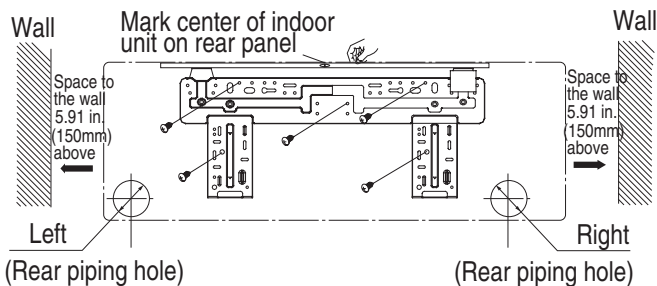

Installing the Piping Hole

1. Drill the piping hole at a slight downward angle to the outside.
2. Insert the piping-hole sleeve into the prepared hole to prevent damage to piping and wiring. (field supplied).

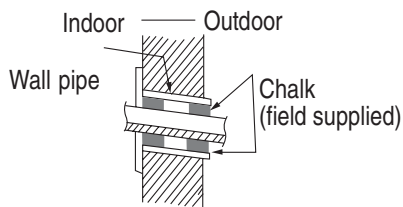

Installing the Condensate Water Drain

1. For wall drainage, the condensate pipe should be installed at a slight downward angle.
2. Do not pull or bend the condensate pipe. No trap requirement.
3. Wrapping the condensate hose in insulation is recommended.

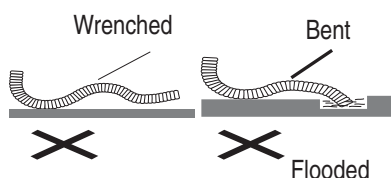

Connecting Indoor and Outdoor Electrical Wiring

1. All wiring should follow the enclosed wiring diagrams.
2. Tilt front panel up.
3. Remove cover plate screws and remove cover plate.
4. Put the power connection cable through the hole in the back of the indoor unit and pull it out as far as it will go.
5. Put the sheathed power connection cable into the wire groove; reattach cover plate with screws. Tighten the connection wire.
6. Replace front panel cover.
7. Signal connection wire should be passed through the indoor unit connection using wire clip under the body case. Tighten the connection wire.

NOTE: If electric connection cable is not long enough, contact qualified service professional for cable of correct length.

- Incorrect connection of electrical connection cable can cause malfunction in unit.
- Securely tighten the terminal screw to keep it from coming loose.
- After tightening the terminal screw, pull slightly on wire to assure tight connection.
- Make sure ground wire is properly attached to prevent electric shock.
- The cover plate must be firmly closed and connection wire tightened to prevent dust, debris and condensation from forming inside the unit, which could cause fire or electric shock.
- Circuit breaker must be of correct capacity for safe operation.

INSTALLING THE INDOOR UNIT

Install the Indoor Unit

Piping may lead out from right, right rear, left or left rear.

1. When installing piping and wiring from left or right side, cut off the tailings from the chassis. (See Fig. 2.)
 - Cut off tailing 1 when installing wiring only.
 - Cut off both 1 and 2 when installing wiring and piping.
2. Remove piping from the body case, wrap the piping electric wire and water pipe with tape, and put them through the piping hole. (See Fig. 3.)
3. Align the mounting slots of the indoor unit on the upper tabs of the rear panel and check that the connection is firm. (See Fig. 4.)

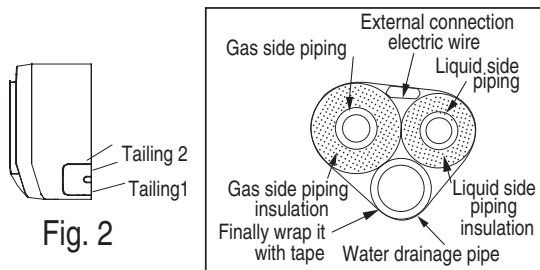

Fig. 2

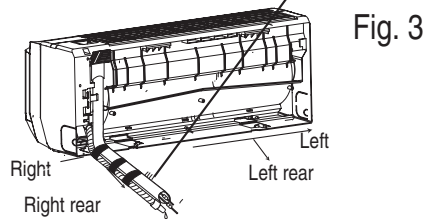

Fig. 3

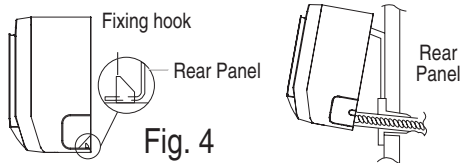
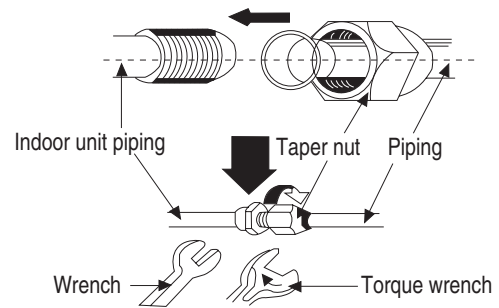

Fig. 4

Install the Refrigerant Pipes

1. Align the center of the piping flare with appropriate valve.



2. Tighten the flare nut by hand, then tighten securely with screwdriver or torque wrench according to the following guidelines:

Tightening torque table

Tube diameter	Torque ft-lb (N-m)
1/4" (6 mm)	11-15 (15-20)
3/8" (9.5 mm)	23-26 (31-35)
1/2" (12 mm)	37-41 (50-55)
5/8" (16 mm)	44-48 (60-65)
3/4" (19 mm)	52-55 (70-75)

NOTE:

Connect refrigerant lines to indoor unit first, then to outdoor unit.

Be careful not to bend or kink refrigerant lines.

Over tightening refrigerant line flare nuts may cause damage.

INSTALLING THE OUTDOOR UNIT

Electrical Wiring

1. Disassemble handle on front or right-hand side plate of outdoor unit.
2. Remove wire clamp. Connect power connection cable to line bank. Connections should be same as for indoor unit.
3. Use the wire clamp to connect the power connection cable on heating and cooling units, then the signal control wire. Then connect the corresponding connectors.
4. Verify that all connections are secure.
5. Reinstall the handle.

NOTE:

- Incorrect wiring can cause malfunction.
- Be sure there is adequate spacing between the wires.

Leakage Test

1. Connect the charging hose of the manifold valve to charge the end of the low-pressure valve.
NOTE: Both high- and low-pressure valves must be tightly closed.
2. Add dry nitrogen to a pressure of 200 lbs and leak test flare fittings with soap bubbles. If no leak is detected, release nitrogen and evacuate system to below 500 microns.
3. Connect the joint of the charging hose to the vacuum pump.
4. Open the handle of the Lo manifold valve.
5. Open the vacuum pump to evacuate the hose. When the charging is beginning, loosen the joint nut on the low-pressure valve to check airflow. If readings are accurate (0 on the multi-meter), retighten the nut.
6. Continue evacuating for at least 15 minutes. Be sure the reading on the vacuum gage is 500 microns or less.
7. Remove the charging hose from the low-pressure end of the low-pressure valve.
8. Tighten the bonnet of the low-pressure valve.
(See Fig. 5.)

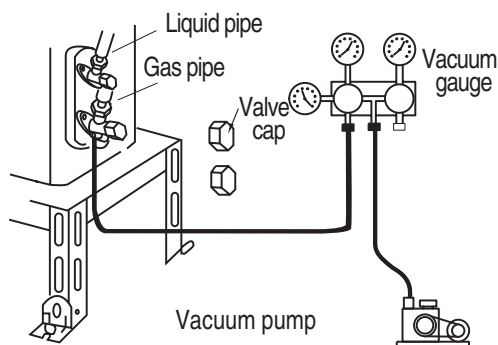

Fig. 5

Check for Leaks

Use soapy water or leak detector to verify joints, connections and couplings are not leaking.

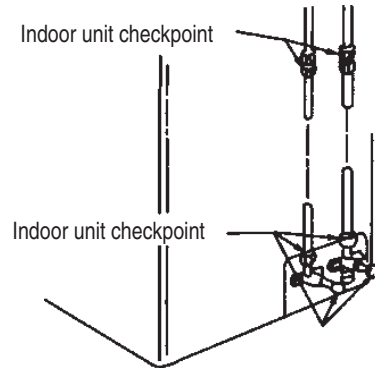

Fig. 6

Outdoor Condensation Drainage

When the unit is heating, the condensing water and defrosting water can be safely drained off through the drain hose.

INSTALLATION:

Install the outdoor drain fitting in the hole on the base plate; then connect the drain hose, directing it so that the water drains out safely.

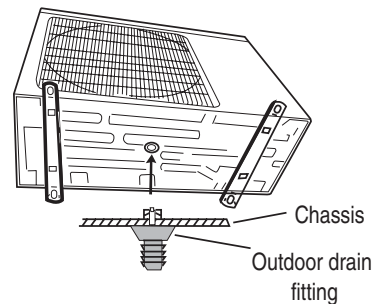

AFTER INSTALLATION AND TESTING

USE THIS CHECKLIST TO VERIFY PROPER INSTALLATION:

ITEM TO BE CHECKED	POSSIBLE MALFUNCTION
Unit is firmly installed.	Unit may shake or emit noise.
Leak test has been performed.	Unit will not heat or cool efficiently.
Sufficient insulation has been installed.	May cause condensation or dripping.
Water is draining properly.	May cause condensation or dripping.
Voltage as prescribed by information on the nameplate.	Could cause electrical malfunction.
Electrical wiring and piping are installed properly and securely.	Could cause electrical malfunction and damage the unit.
The unit is properly grounded.	Could cause electrical leakage.
Electrical cables are as specified.	Could cause electrical malfunction.
Air Inlet and outlet are not covered.	May cause insufficient cooling or heating.
Record the length of the connection pipes and refrigerant capacity.	Refrigerant capacity is not accurate.

Pre-Start-Up Procedure

Test operation method:

1. Verify service valves are open.
2. Switch on power. Press ON/OFF button on wireless remote to start operation.
3. Press the MODE button on the wireless remote to check that COOL, HEAT or FAN modes are operating correctly.

CIRCUIT DIAGRAMS

Indoor Unit

For 230V models:

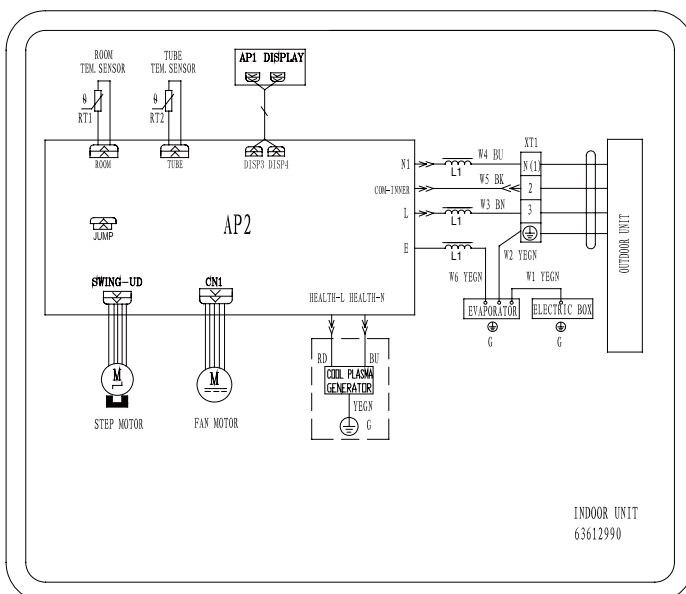

For 115V models:

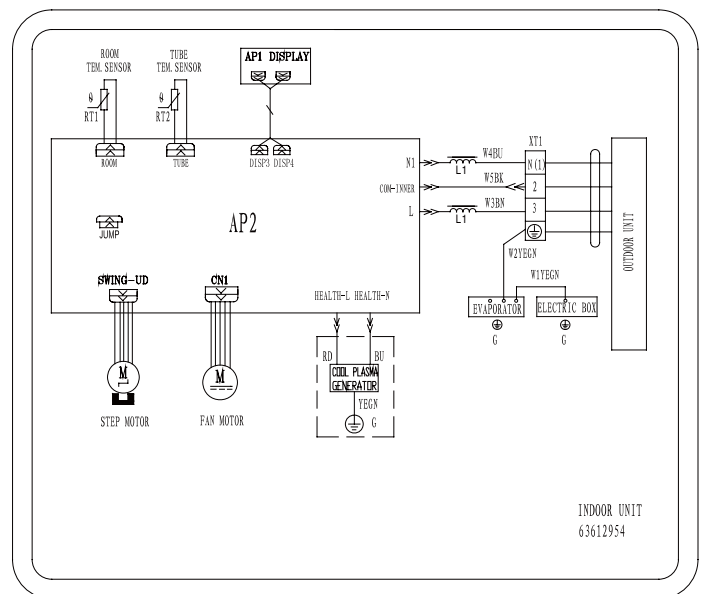

CIRCUIT DIAGRAMS

Outdoor Unit

For 230V heat pump models:

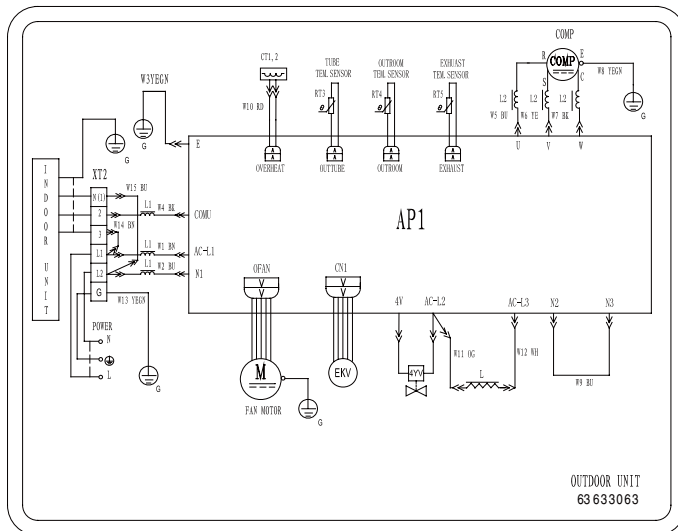

For 230V cool only models:

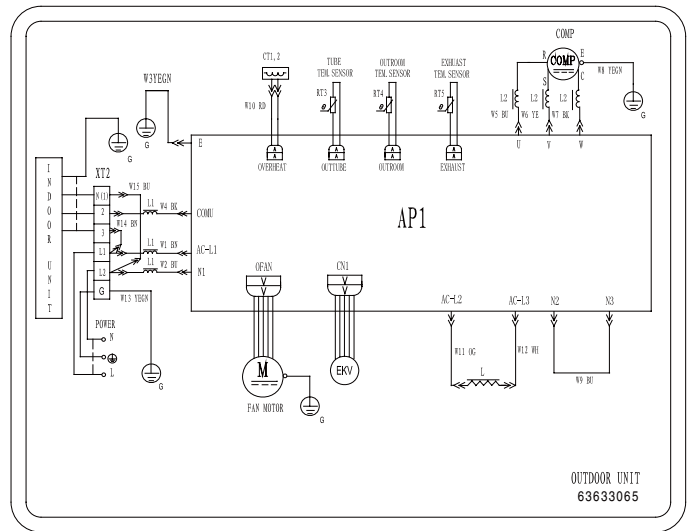

For 115V heat pump models:

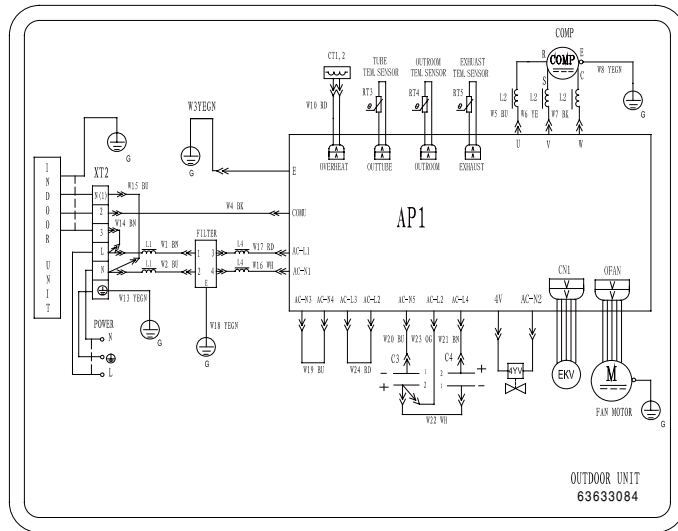

For 115V cool only models:

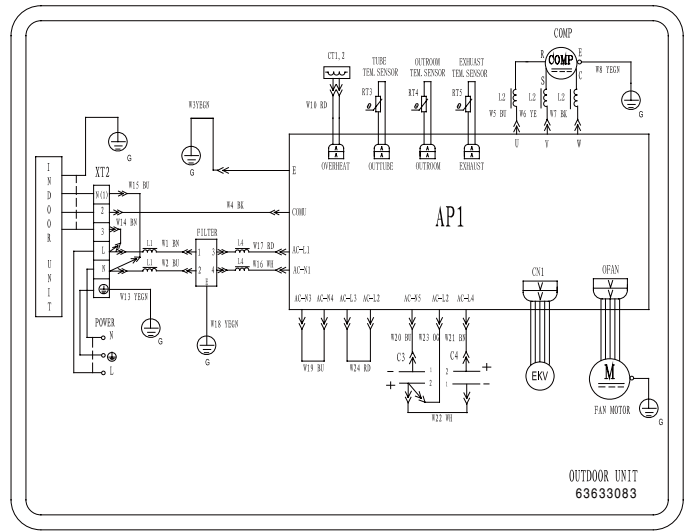



LIMITED WARRANTY

9,000 to 24,000 BTUH - Ductless Split System

GWH09AB-A3DNA1B; GWH12AB-A3DNA1B;

GWH12AB-D3DNA1B; GWH18AB-D3DNA1B; GWH24AB-D3DNA1B

FOR WARRANTY SERVICE OR REPAIR:

Contact your installing contractor. You may find the installer's name on the equipment or in your Owner's packet.

PRODUCT REGISTRATION:

Go to www.greecooling.com to complete the product warranty registration.

Outdoor Model No.: _____ Serial No.: _____

Indoor Model No.: _____ Serial No.: _____

Date of Installation: _____

Owner Name: _____ Address of Installation: _____

Installing Contractor: _____

Address / Phone No.: _____

GREE Distributor (hereinafter "Company") warrants this product against failure due to defect in materials or workmanship under normal use and maintenance as follows. All warranty periods begin on the date of original purchase from wholesaler/supplier. If the date cannot be verified, the warranty period begins one hundred twenty (120) days from date of manufacture. If a part fails due to defect during the applicable warranty period Company will provide a new or remanufactured part, at Company's option, to replace the failed defective part at no charge for the part. This limited warranty is subject to all provisions, conditions, limitations and exclusions listed below.

- Five (5) years on all functional Parts, including compressor - All parts (including compressor) are warranted for a period of five (5) years to the original registered end-user.
- 90-day warranty on remote control unit.
- Proper installation - Limited warranty applies only to systems that are installed by a state certified or licensed HVAC contractors, under applicable local and state law in accordance with all applicable building codes and permits; GREE installation and operation instructions and good trade practices.
- Warranty applies only to products remaining in their original installation location.
- Defective parts must be returned to the distributor through a registered servicing dealer for credit.

LIMITATIONS OF WARRANTIES: ALL IMPLIED WARRANTIES AND/OR CONDITIONS (INCLUDING IMPLIED WARRANTIES OR CONDITIONS OF MERCHANTABILITY AND FITNESS FOR A PARTICULAR USE OR PURPOSE) ARE LIMITED TO THE DURATION OF THIS LIMITED WARRANTY, SOME STATES OR PROVINCES DO NOT ALLOW LIMITATIONS ON HOW LONG AN IMPLIED WARRANTY OR CONDITION LASTS, SO THE ABOVE MAY NOT APPLY TO YOU. THE EXPRESS WARRANTIES MADE IN THIS WARRANTY ARE EXCLUSIVE AND MAY NOT BE ALTERED, ENLARGED, OR CHANGED BY ANY DISTRIBUTOR, DEALER, OR OTHER PERSON, WHATSOEVER.

THIS WARRANTY DOES NOT COVER:

1. Labor or other costs incurred for diagnosing, repairing, removing, installing, shipping, servicing or handling of either defective parts, or replacement parts, or new units.
2. Normal maintenance as outlined in the installation and servicing instructions or Owner's Manual, including filter cleaning and/or replacement and lubrication.
3. Failure, damage or repairs due to faulty installation, misapplication, abuse, improper servicing, unauthorized alteration or improper operation.
4. Failure to start due to voltage conditions, blown fuses, open circuit breakers, or damages due to the inadequacy or interruption of electrical service.
5. Failure or damage due to floods, winds, fires, lightning, accidents, corrosive environments (rust, etc.) or other conditions beyond the control of the Company.
6. Parts not supplied or designated by Company, or damages resulting from their use.
7. Products installed outside USA or its territories and Canada.
8. Electricity or fuel costs, or increases in electricity or fuel costs from any reason whatsoever, including additional or unusual use of supplemental electric heat.
9. Any cost to replace, refill or dispose of refrigerant, including the cost of refrigerant.
10. Any special, indirect or consequential property or commercial damage of any nature whatsoever. Some states or provinces do not allow the exclusion of incidental or consequential damages, so the above limitation may not apply to you.

This warranty gives you specific legal rights, and you may also have other rights which vary from state to state or province to province.

WS0060211

