



# ***Owner's Manual***

## **Original Instructions**

Wired Remote Controller XK19 and  
Wireless Remote Controller YT1F

Thank you for choosing our product.

Please read this Owner's Manual carefully before operation and retain it for future reference.

If you have lost the Owner's Manual, please contact the local agent or visit [www.gree.com](http://www.gree.com) or send an email to [global@gree.com.cn](mailto:global@gree.com.cn) for the electronic version.

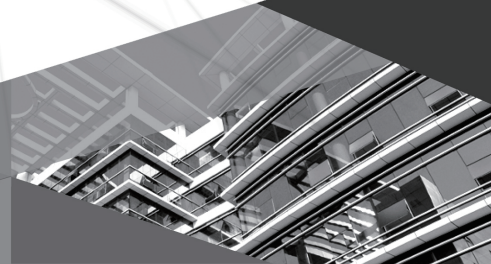

## User Notice

- ◆ Never install the wired remote controller in the moist circumstance or expose it directly under the sunlight.
- ◆ Never beat, throw, and frequently disassemble the wired remote controller and the wireless remote controller.
- ◆ Never operate the wired remote controller and the wireless remote controller with wet hands.
- ◆ Do not remove or install the wired controller by yourself. If there is any question, please contact our after-sales service center.
- ◆ The wired controller is a general model, applicable for several kinds of units. Some functions of the wired controller are not available for certain kinds of units, more details please refer to the owner's manual of unit. The setting of such unavailable function will not affect unit's operation.
- ◆ The wired controller is universal. The remote receiver is either in the indoor unit or in the wired controller. Please refer to the specific models.
- ◆ As for some indoor units connected with the wired controller, if use the remote controller whose set temperature is adjustable under auto mode, the wired controller will receive the mode signal of remote controller, rather than its set temperature under the auto mode.
- ◆ The wired controller is the universal component. When indoor unit has connected with the wired controller, display status of indoor unit is decided by the indoor unit. Valid status and invalid status are all belong to normal status.



**Please read the manual carefully before using and installing this product.**

# Contents

I	Wired Remote Controller XK19 .....	1
1	Symbols on LCD .....	1
1.1	Outside View of the Wired Remote Controller .....	1
1.2	LCD of the Wired Remote Controller .....	1
2	Buttons .....	2
2.1	Buttons on the Wired Remote Controller .....	2
2.2	Function of the Buttons .....	3
3	Operation Instructions .....	4
3.1	On/Off .....	4
3.2	Mode Setting .....	4
3.3	Temperature Setting .....	4
3.4	Fan Setting .....	5
3.5	Timer Setting .....	5
3.6	Swing Setting .....	7
3.7	Fresh Air Valve Function Setting .....	8
3.8	Sleep Setting .....	9
3.9	Turbo Setting .....	10
3.10	Energy Saving Function Setting .....	11
3.11	E-heater Setting .....	12
3.12	Blow Setting .....	13
3.13	Quiet Function Setting .....	14
3.14	Other Functions .....	15
4	Installation and Dismantlement .....	17
4.1	Connection of the Signal Line of the Wired Remote Controller .....	17
4.2	Installation of the Wired Remote Controller .....	17
4.3	Dismantlement of the Wired Remote Controller .....	20
5	Errors Display .....	20
II	Wireless Remote Controller YT1F .....	23
1	Function of Press Buttons .....	23
2	Guide for General Operation .....	25
3	Guide for Optional Operation .....	26

# I Wired Remote Controller XK19

## 1 Symbols on LCD

### 1.1 Outside View of the Wired Remote Controller

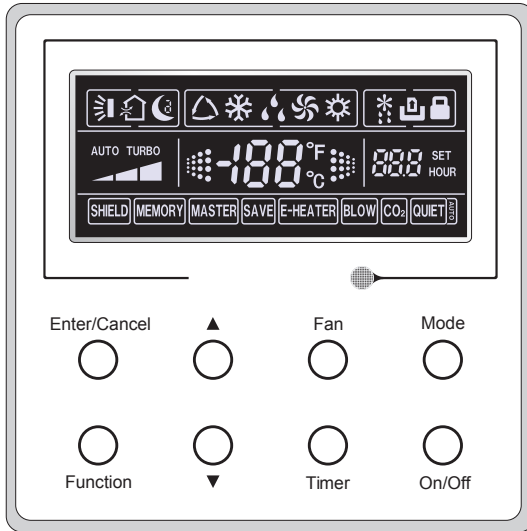

Fig.1 Outside View of the Wired Remote Controller

### 1.2 LCD of the Wired Remote Controller

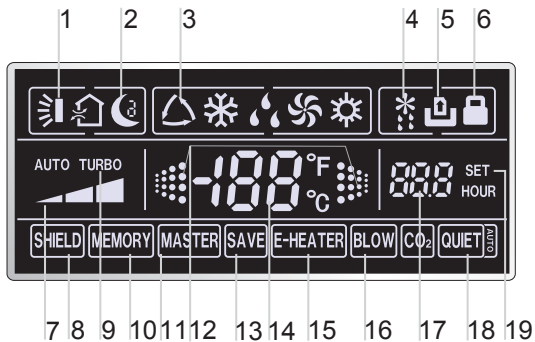

Fig.2 LCD of the Wired Remote Controller

Table 1

No.	Symbols	Description
1		Swing function.
2		Sleep function.
3		Running modes of the indoor unit (Cooling, Dry, Fan and Heating).
4		Defrosting function for the outdoor unit.
5		Gate-control function
6		Lock function.
7		High, middle, low or auto fan speed of the indoor unit.
8		Shield functions (buttons, temperature, On/Off or Mode is shielded by the remote monitor).
9		Turbo function.
10		Memory function (The indoor unit resumes the original setting state after power failure and then power recovery).
11		Master wired remote controller (this function is yet unavailable for this unit).
12		It blinks under on state of the unit without operation of any button.
13		Energy-saving function.
14		Ambient/preset temperature value.
15		Electric auxiliary heating function.
16		Blow function.
17		Timing value.
18		Quiet function (two types: quiet and auto quiet)
19	SET	It will be displayed under the debugging mode.

## 2 Buttons

### 2.1 Buttons on the Wired Remote Controller

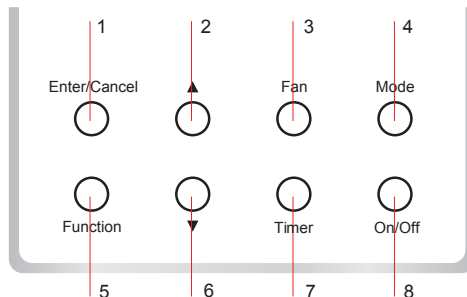



Fig. 3 Buttons on the Wired Remote Controller

2.2 Function of the Buttons

Table 2

No.	Name	Function
1	Enter/Cancel	Function selection and cancellation.
2	▲	① Running temperature setting of the indoor unit, range:16~30 C (61~86°F). ② Timer setting, range:0.5-24 hr.
6	▼	
3	Fan	Setting of the high/middle/low/auto fan speed.
4	Mode	Setting of the Cooling/Heating/Fan/Dry/Auto mode of the indoor unit.
5	Function	Switchover among the functions of Turbo/Save/E-heater/Blow etc..
7	Timer	Timer setting.
8	On/Off	Turn on/off the indoor unit.
4+2	▲+Mode	Press them for 5s under off state of the unit to Enter/Cancel the Memory function(If memory is set, indoor unit after power failure and then power recovery willresume the original setting state. If not, the indoor unit is defaulted to be off after power recovery. Memory off is default before delivery.).
3 +6	Fan+▼	By pressing them at the same time under off state of the unit,  will be displayed on the wired remote controller for the cooling only unit, while  will be displayed on the wired remote controller for the cooling and heating unit.
2 +6	▲+▼	Upon startup of the unit without malfunction or under off state of the unit,press them at the same time for 5s to enter the lock state, in which case, any other buttons won't respond the press. Repress them for 5s to quit this state.
4+6	Mode+▼	Under OFF state, the Celsius and Fahrenheit scales can be switched by pressing "Mode" and "▼" for five seconds.
5+7	Function+Timer	Under OFF state, it is available to go to the commissioning status by pressing "Function" and "Timer" for five seconds, and let "00" displayed on the temperature display area by pressing "Mode", then adjust the options which is shown on the timer area by pressing "▲" and "▼". There are totally four options, as follows: ① Indoor ambient temperature is sensed by the return air temperature sensor ( 01 displayed on the timer area). ② Indoor ambient temperature is sensed by the wired controller (02 displayed on the timer area). ③ The return air temperature sensor is selected under the cooling, dry, or fan mode; while the wired controller temperature sensor is selected under the heating or auto mode. (03 is displayed on the timer area). ④ The wired controller temperature sensor is selected under the cooling, dry, or fan mode; while the return air temperature sensor is selected under the heating mode. (04 is displayed on the timer display area).
5+7	Function+Timer	Under OFF state, it is available to go to the commissioning status by pressing "Function" and "Timer" for five seconds. Press "Mode" button to until "01" icon is shown at the temperature display area. The setting status will be shown at timer area. Press "▲" and "▼" button to adjust and two options are available: ① Three low levels (01) ; ② Three high levels (02).

### 3 Operation Instructions

#### 3.1 On/Off

Press On/Off to turn on the unit and turn it off by another press.

Note: The state shown in Fig.4 indicates the “Off” state of the unit after power on. The state shown in Fig.5 indicates the “On” state of the unit after power on.

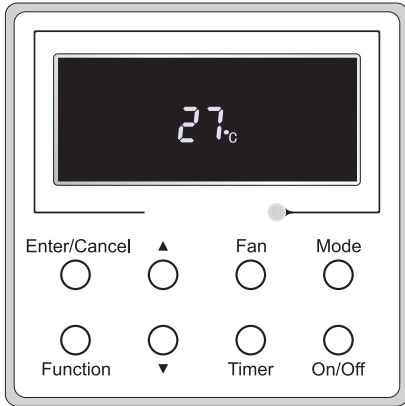

Fig. 4 “Off” State

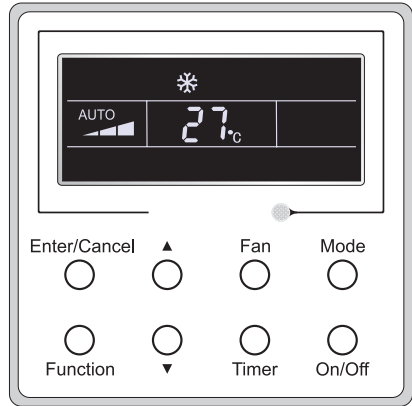
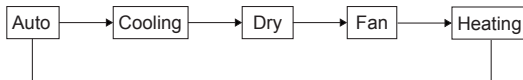

Fig. 5 “On” State

#### 3.2 Mode Setting

Under the “On” state of the unit, press Mode to switch the operation modes as the following sequence:Auto-Cooling-Dry-Fan-Heating.



#### 3.3 Temperature Setting

Press ▲ or ▼ to increase/decrease the preset temperature. If press either of them continuously, the temperature will be increased or decreased by 1°C (1°F) every 0.5s, as shown in Fig.6.

In the Cooling, Dry, Fan or Heating mode, the temperature setting range is 16~30°C (61~86°F).

In the Auto mode, the setting temperature is unadjustable.

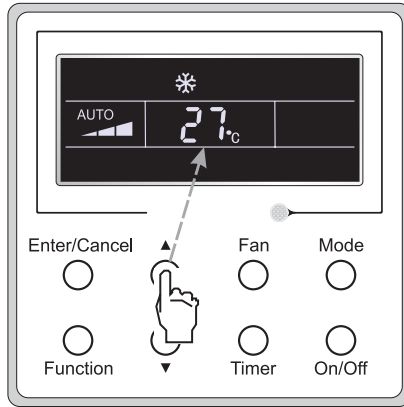

Fig.6

### 3.4 Fan Setting

Under the “On”/”Off” state of the unit, press Fan and then fan speed of the indoor unit will change circularly as shown in Fig.7.

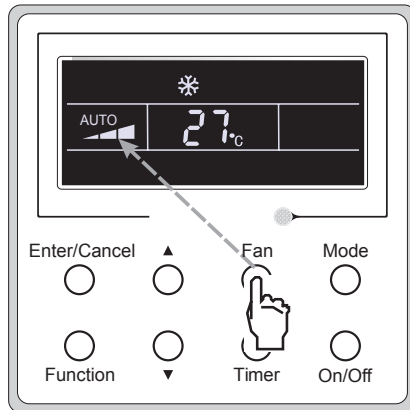
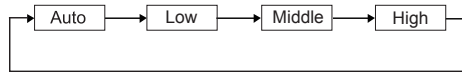

Fig.7

### 3.5 Timer Setting

Under the “On”/”Off” state of the unit, press Timer to set timer off/on.

Timer on setting: press Timer, and then LCD will display “xx.x hour”, with “hour” blinking. In this case, press ▲ or ▼ to adjust the timing value. Then press Enter/Cancel to confirm the setting.

Timer off setting: press Timer, if LCD won't display xx.x hour, and then it means the timer setting is canceled.

Timer off setting under the “On” state of the unit is shown as Fig.8.



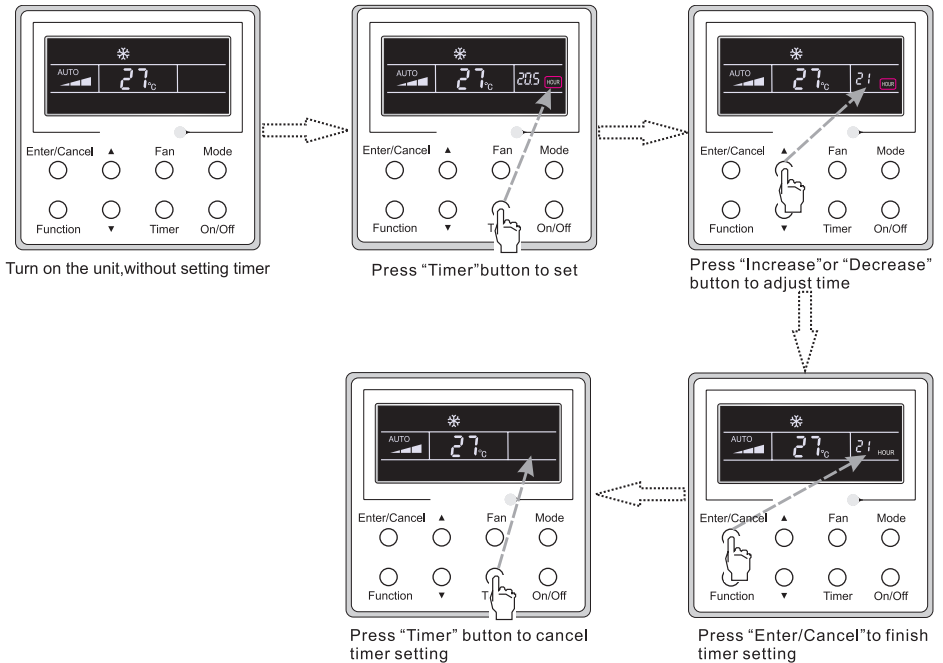



Fig. 8 Timer off Setting under the "On" State of the Unit

Timer range: 0.5-24hr. Every press of ▲ or ▼ will make the set time increased or decreased by 0.5hr. If either of them is pressed continuously, the set time will increase/ decrease by 0.5hr every 0.5s.

### 3.6 Swing Setting

Swing On: Press Function button under on state of the unit to activate the swing function. In this case,  will blink. After that, press Enter/Cancel to make a confirmation.

Swing Off: When the Swing function is on, press Function button to enter the Swing setting interface, with  blinking. After that, press Enter/Cancel to cancel this function.

Swing setting is shown as Fig.9.

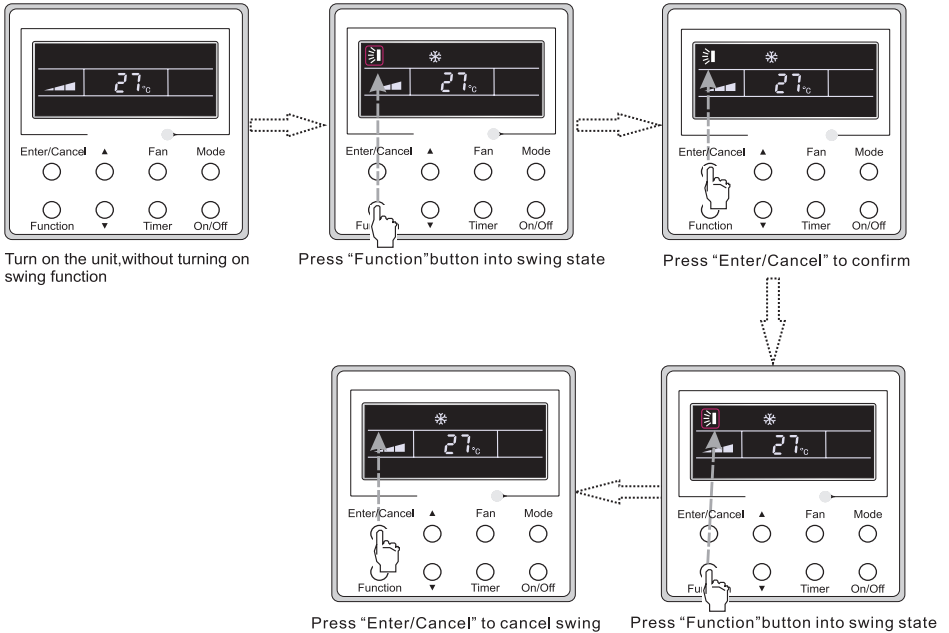



Fig. 9 Swing Setting

Note:

- ① . Sleep, Turbo or Blow setting is the same as the Swing setting.
- ② . After the setting has been done, it has to press the key "Enter/Cancel" to back to the setting status or quit automatically five seconds later.

### 3.7 Fresh Air Valve Function Setting

Turn on fresh air valve function:

Under unit on status, press Function button on the panel to select “Fresh air valve” function option. When  icon flashes, it enters fresh air valve setting mode. Previous temperature display position will display the level of fresh air valve. Press ▲ or ▼ button to adjust the level of fresh air valve within the range from 1 to 10. Then press Enter/Cancel button to activate this function.

Turn off fresh air valve function:

If fresh air valve function has been set, press Function button on the panel to select “Fresh air valve” function option. When  icon flashes, if you press Enter/Cancel button without pressing ▲ or ▼ button, fresh air valve function will be canceled; if you press Enter/Cancel button after pressing ▲ or ▼ button, fresh air valve function will be activated.

Note:

if you press panel button to set fresh air valve function on, ventilation (ventilation 1) function will be activated too; if you press panel button to set fresh air valve function off, ventilation function will be canceled too.

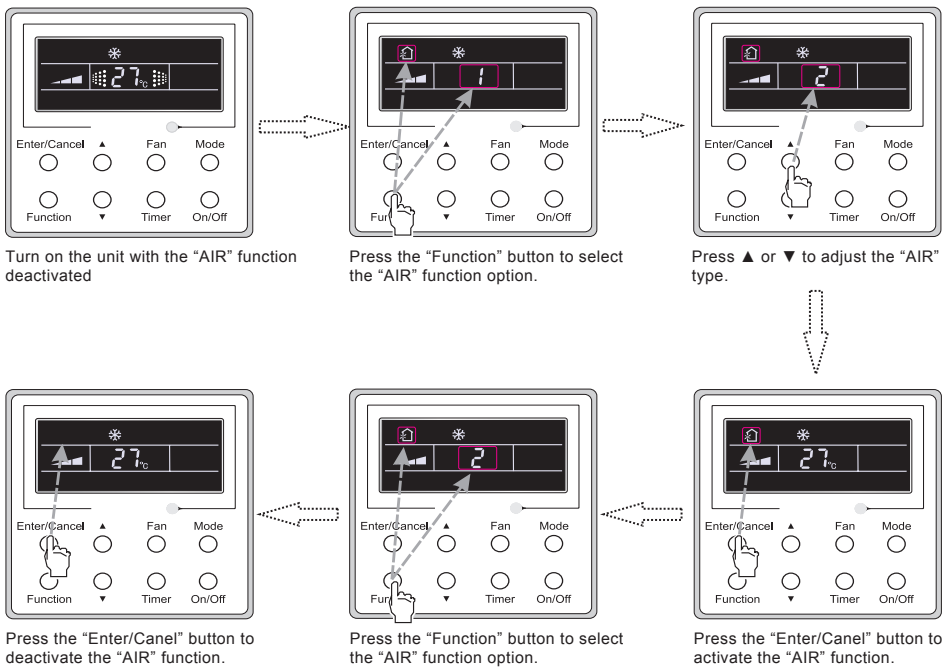

Fig. 10 Fresh Air Function Setting

### 3.8 Sleep Setting

**Sleep on:** Press Function under on state of the unit till the unit enters the Sleep setting interface. Press Enter/Cancel to confirm the setting.

**Sleep off:** When the Sleep function is activated, press Function to enter the Sleep setting interface. After that, press Enter/Cancel to can this function.

In the Cooling or Dry mode, the temperature will increase by 1°C after the unit runs under Sleep 1 for 1hr and 1°C after another 1hr. After that, the unit will run at this temperature.

In the Heating mode, the temperature will decrease by 1°C after the unit runs under Sleep 1 for 1hr and 1°C after another 1hr. After that, the unit will run at this temperature.

Sleep setting is shown as Fig.11.

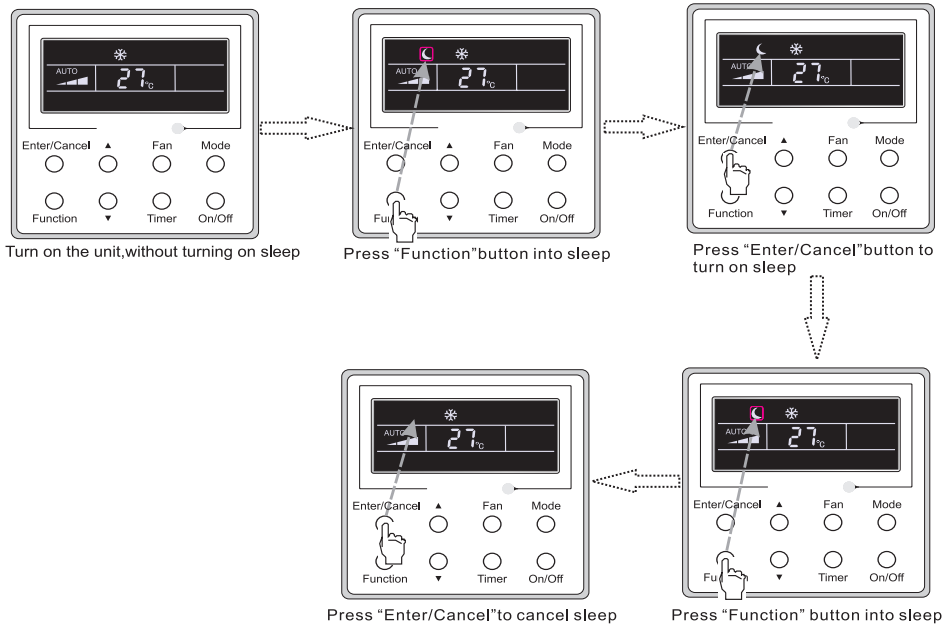

Fig. 11 Sleep Setting

### 3.9 Turbo Setting

Turbo function: The unit at the high fan speed can realize quick cooling or heating so that the room temperature can quickly approach the setting value.

In the Cooling or Heating mode, press Function till the unit enters the Turbo setting interface and then press Enter/Cancel to confirm the setting.

When the Turbo function is activated, press Function to enter the Turbo setting interface and then press Enter/Cancel to cancel this function.

Turbo function setting is as shown in Fig.12.

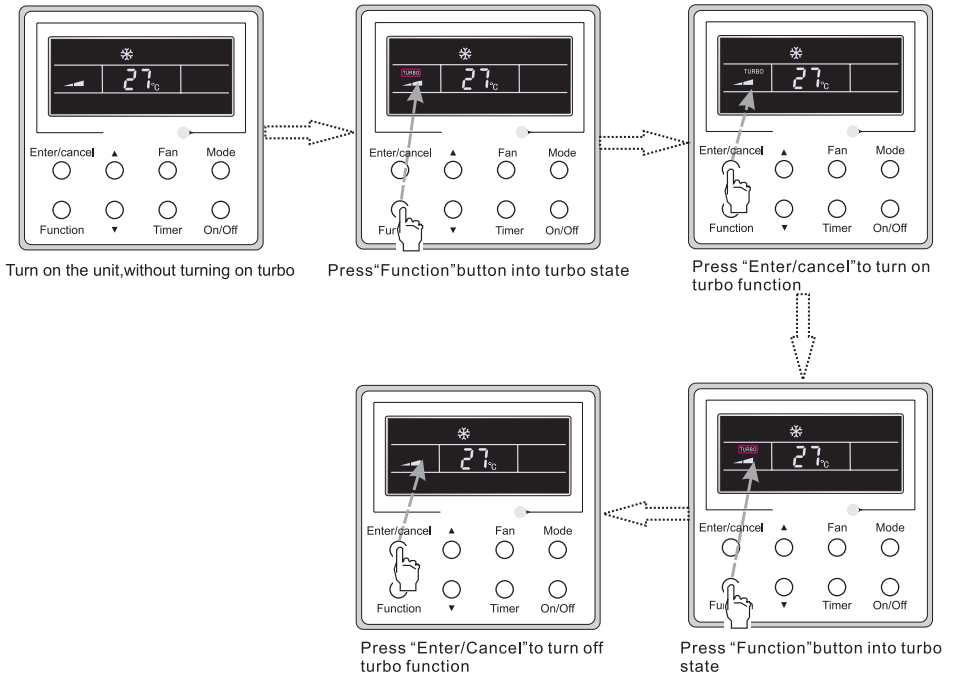

Fig.12 Turbo Setting

### 3.10 Energy Saving Function Setting

Turn on energy saving function:

1) Energy Saving Setting for Cooling

When the unit runs under the COOL or DRY mode, press Function button to select "SAVE" function option, with "SAVE" flashing, and then press ▲ or ▼ to adjust the lower limit, after that, press the Enter/Cancel button to activate this function.

2) Energy Saving Setting for Heating

When the unit runs under the HEAT mode, press Function button to select "SAVE" function option, with "SAVE" flashing, and then press ▲ or ▼ to adjust the upper limit, after that, press Enter/Cancel button to activate this function.

Note:

under energy saving setting mode, press "MODE" button to switch the energy saving setting for COOL or HEAT mode.

Cancel energy saving function:

If energy saving function has been set, press Function button on the panel to select "SAVE" function option. When  icon flashes, if you press Enter/Cancel button without pressing ▲ or ▼ button, energy saving function will be canceled; if you press Enter/Cancel button after pressing ▲ or ▼ button, energy saving function will be activated.

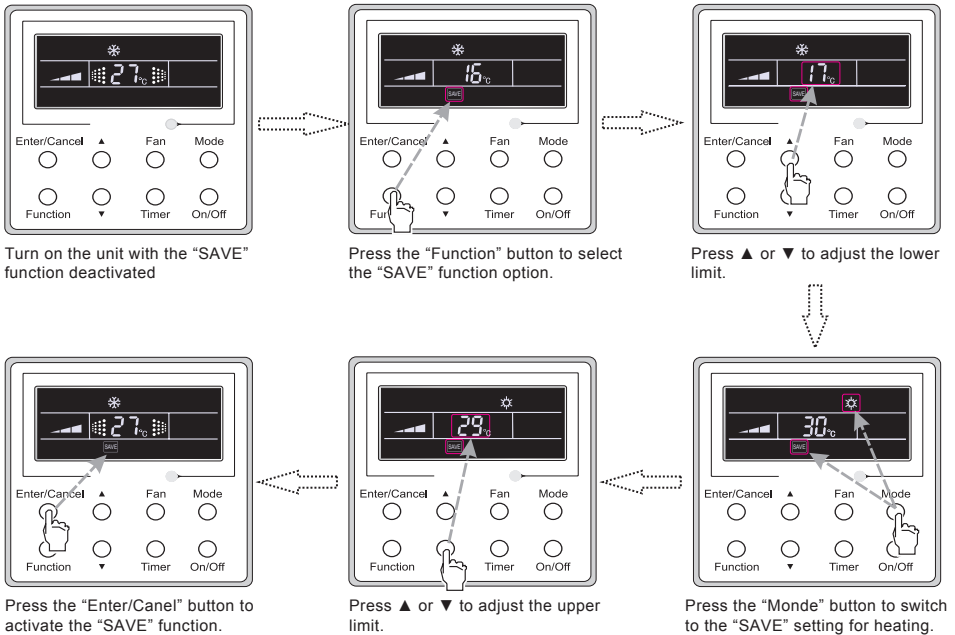

Fig. 13 Energy Saving Function Setting

### 3.11 E-heater Setting

E-heater (auxiliary electric heating function): In the Heating mode, E-heater is allowed to be turned on for improvement of efficiency.

Once the wired remote controller or the remote controller enters the Heating mode, this function will be turned on automatically.

Press Function in the Heating mode to enter the E-heater setting interface and then press Enter/Cancel to cancel this function.

Press Function to enter the E-heater setting interface, if the E-heater function is not activated, and then press Enter/Cancel to turn it on.

The setting of this function is shown as Fig.14 below:

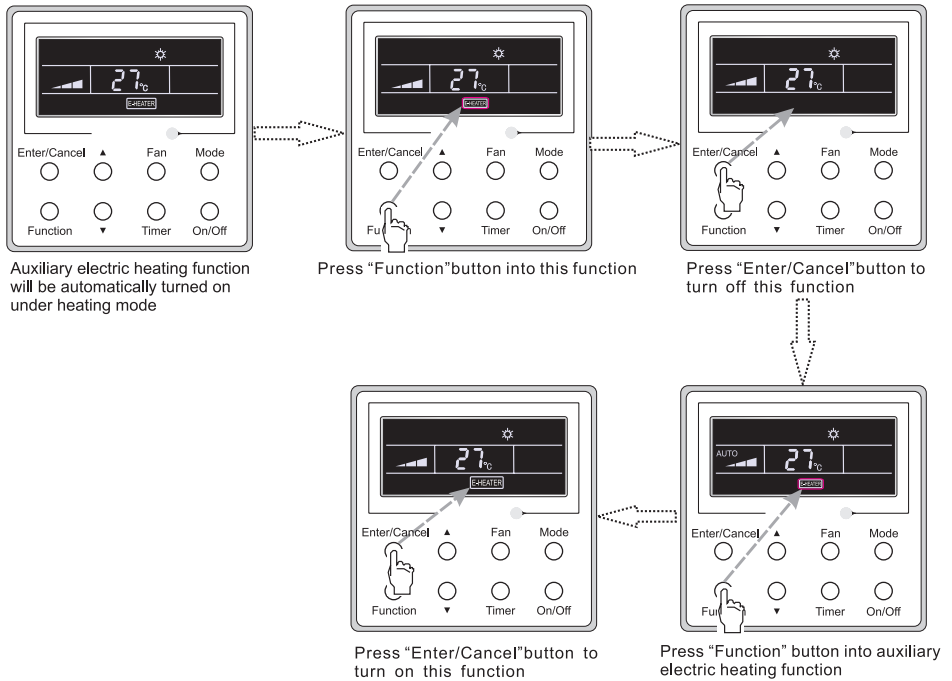

Fig.14 E-heater Setting

### 3.12 Blow Setting

Blow function: After the unit is turned off, the water in evaporator of indoor unit will be automatically evaporated to avoid mildew.

In the Cooling or Dry mode, press Function till the unit enters the Blow setting interface and then press Enter/Cancel to activate this function.

When the Blow function is activated, press Function to the Blow setting interface and then press Enter/Cancel to cancel this function.

Blow function setting is as shown in Fig.15

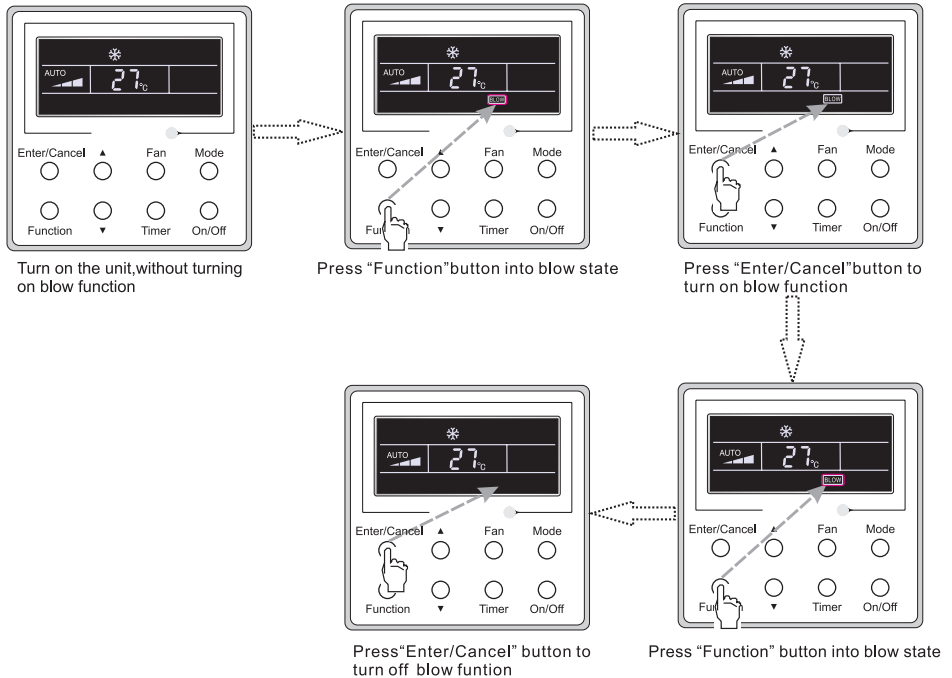

Fig.15 Blow Setting

**Notes:**

- ① . When the Blow function is activated, if turning off the unit by pressing On/Off or by the remote controller, the indoor fan will run at the low fan speed for 2 min, with "BLOW" displayed on the LCD. While, if the Blow function is deactivated, the indoor fan will be turned off directly.
- ② . Blow function is unavailable in the Fan or Heating mode.



### 3.13 Quiet Function Setting

Turn on quiet function:

Under unit on status, press Function button on the panel to select “Quiet” function option. When “Quiet” or “Auto quiet” flashes, it enters quiet function setting mode. Press ▲ or ▼ button to switch between “Quiet” and “Auto quiet” function. Then press Enter/Cancel button to activate this function.

Cancel quiet function:

If quiet function has been set, press Function button on the panel to select “Quiet” function option. When “Quiet” or “Auto quiet” flashes, if you press Enter/Cancel button without pressing ▲ or ▼ button, quiet function will be canceled; if you press Enter/Cancel button after pressing ▲ or ▼ button, quiet function will be activated.

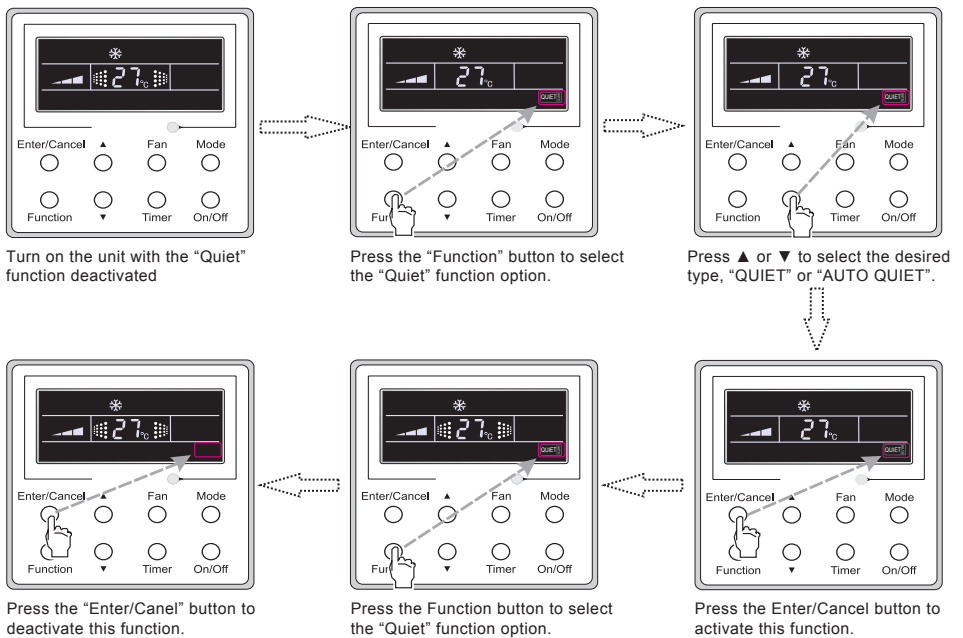



Fig. 16 Setting of Quiet Function

### 3.14 Other Functions

#### (1). Lock

Upon startup of the unit without malfunction or under the “Off” state of the unit, press ▲ and ▼ at the same time for 5s till the wired remote controller enters the Lock function. In this case, LCD displays . After that, repress these two buttons at the same time for 5s to quit this function.

Under the Lock state, any other button press won't get any response.

#### (2). Memory

Memory switchover: Under the “Off” state of the unit, press Mode and ▲ at the same time for 5s to switch memory states between memory on and memory off. When this function is activated, Memory will be displayed. If this function is not set, the unit will be under the “Off” state after power failure and then power recovery.

Memory recovery: If this function has been set for the wired remote controller, the wired remote controller after power failure will resume its original running state upon power recovery. Memory contents: On/Off, Mode, set temperature, set fan speed and Lock function.

#### (3). Selection of the Temperature Sensor

Under OFF state of the unit, press both “Function” and “Timer” for five seconds to go the commissioning status. Under this status, adjust the display in the temperature display area to “00” through the button “Mode”, and then adjust the option of the temperature sensor in the timer display area through the button ▲ or ▼.

- ① . Indoor ambient temperature is sensed at the return air inlet(01 in the timer display area).
- ② . Indoor ambient temperature is the sensed at the wired controller(02 in the timer display area).
- ③ . Select the temperature sensor at the return air inlet under the cooling, dry and fan modes, while select the temperature sensor at the wired controller under the heating and auto modes.(03 in the timer display area).
- ④ . Select the temperature sensor at the wired controller under the cooling, dry and fan modes, and select the temperature sensor at the return air inlet under the heating mode and auto modes (04 displayed in the timer display area).

After the setting, press “Enter/Cancel” to make a confirmation and quit this setting status.

Pressing the button “On/Off” also can quit this commissioning status but the set data won't be memorized.

Under the commissioning status, if there is no any operation in 20 seconds after the last button press, it will back to the previous state without memorizing the current data.

Note:

After connected with indoor unit, if the type of ambient temperature sensor has not been manually set, the wired controller will select the ambient temperature sensor according to the model of connected IDU; if it connects to cassette type IDU, duct type IDU, floor ceiling type IDU, ceiling type IDU, it will adopt ③, otherwise it will adopt ①. If the type of ambient temperature sensor is set manually, the wired controller will subject to the manual setting, and will not set according to automatic IDU model selection.

#### (4). Selection of the Fan Speed

Under OFF state of the unit, press both the buttons “Function” and “Timer” for five seconds to

go to the commissioning status, and then adjust the display in the temperature display area to 01 through the button "Mode" and adjust the setting of the fan speed, which comes to two options.

01: Three low fan speeds; 02: Three high fan speeds

After the setting, press "Enter/Cancel" to make a confirmation and quit this setting status.

Pressing the button "On/Off" also can quit this commissioning status but the set data won't be memorized.

Under the commissioning status, if there is no any operation in 20 seconds after the last button press, it will back to the previous state without memorizing the current data.

## 4 Installation and Dismantlement

### 4.1 Connection of the Signal Line of the Wired Remote Controller

- Open the cover of the electric control box of the indoor unit.
- Let the single line of the wired remote controller through the rubber ring.
- Connect the signal line of the wired remote controller to the 4-pin socket of the indoor unit PCB.
- Tighten the signal wire with ties.
- The communication distance between the main board and the wired remote controller can be up to 20 meters ( the standard distance is 8 meters)

### 4.2 Installation of the Wired Remote Controller

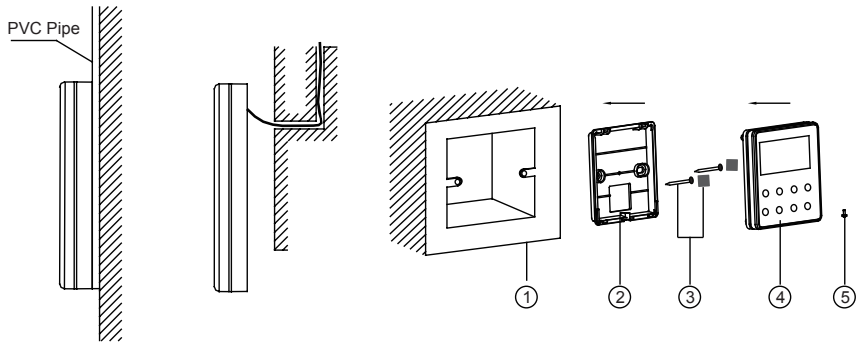

Fig.17 Accessories for the Installation of the Wired Remote Controller

Table 3

No.	1	2	3	4	5
Name	Socket box embedded in the wall	Soleplate of the Wired Remote Controller	Sponge 20x20x2 Screw M4X25	Front Panel of the Wired Remote Controller	Screw ST2.9X6

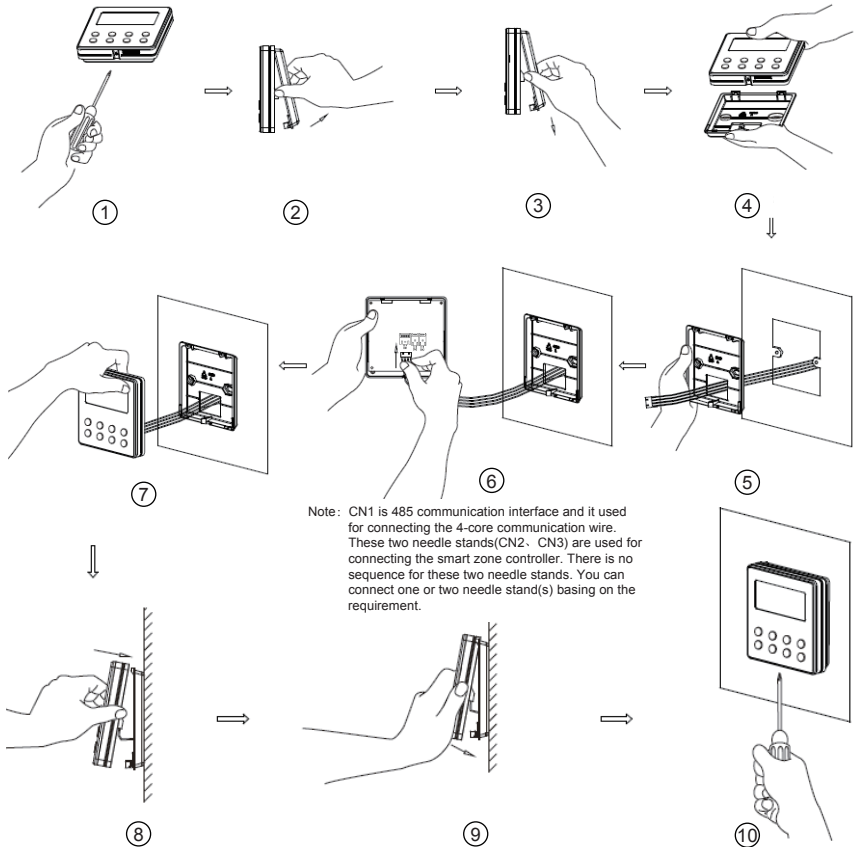

Fig.18

- Fig.18 shows the installation steps of the wired remote controller, but there are some issues that need your attention.
- (1). Prior to the installation, please firstly cut off the power supply of the wire buried in the installation hole, that is, no operation is allowed with electricity during the whole installation.
  - (2). Pull out the four-core twisted pair line from the installation holes and then let it go through the rectangular hole behind the soleplate of the wired remote controller.
  - (3). Stick the soleplate of wired controller on the wall and then use screw M4×25 to fix soleplate and installation hole on wall together, attach the sponge 20×20×2 at the screw hole and then press it with fingers to make sure it's attached firmly.
  - (4). Insert the four-core twisted pair line into the slot of the wired remote controller and then buckle the front panel and the soleplate of the wired remote controller together.
  - (5). Finally, fix the front panel and the soleplate of the wired remote controller tightly by screws ST2.9X6.

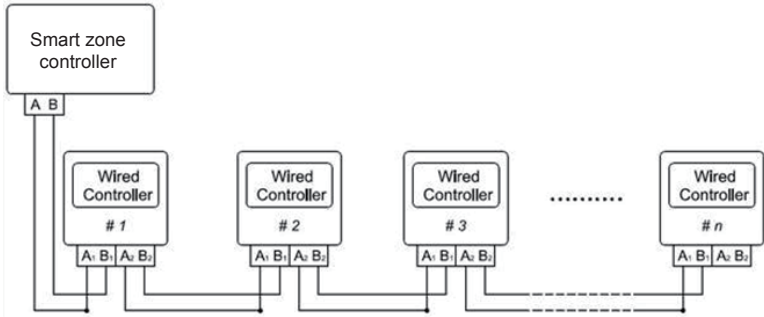

Fig.19

Fig.19 shows the schematic diagram of control system connection. XK19 can connect the smart zone controller (integrated control system). “n” indicates the number of communication node address (programmable wired controller XK19). The complete system is composed of the smart zone controller, wired controller XK19 and communication cable. The wired controller XK19 can support 16 communication node addresses at the most ( $n \leq 16$ ).

Terminal A and terminal B of the smart zone controller are respectively connected to the corresponding communication needle stand terminal of the #1wired controller by the communication cable; the other needle stand of #1 wired controller is connected to the #2 wired controller through the telecommunication cable and so forth until connect to the #n wired controller. Except the last wired controller in the control system (only use CN2 or CN3, and the other one will not be connected), there’s no the sequence and the importance for the wired controller. The series number in the figure is only for the sake of clarity.

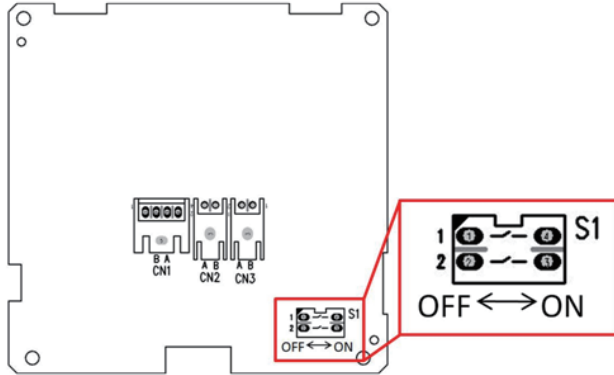

Fig.20

Fig.20 shows schematic diagram of DIP switch. There is a 2-bit DIP switch on the main board of wired controller XK19. As for the last #n wired controller in the control system, the 1-bit and the 2-bit of the DIP switch should be manually pulled to position “on” and position “off” respectively. The DIP switches of other wired controllers should be kept at the initial ex-factory status (1-bit and 2-bit are set at position “off”).

**⚠ CAUTION!**

Please pay special attention to the followings during the connection to avoid the malfunction of the air conditioning unit due to electromagnetic interference.

- ① . Separate the signal and communication lines of the wired remote controller from the power

cord and connection lines between the indoor and outdoor unit, with a minimum interval of 20cm, otherwise the communication of the unit will probably work abnormally.

② . If the air conditioning unit is installed where is vulnerable to electromagnetic interference, then the signal and communication lines of the wired remote controller must be the shielding twisted pair lines.

### 4.3 Dismantlement of the Wired Remote Controller

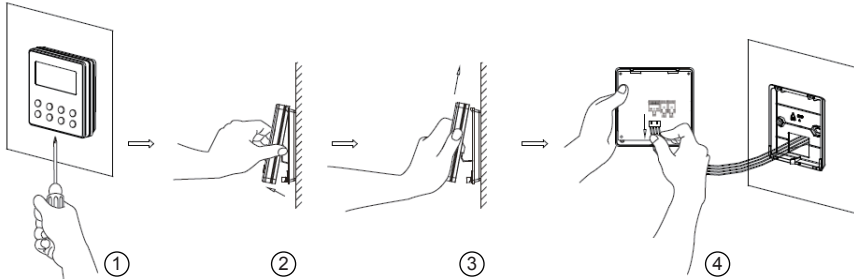

## 5 Errors Display

If there is an error occurring during the operation of the system, the error code will be displayed on the LCD, as show in Fig.21. If multi errors occur at the same time, their codes will be displayed circularly.

**Note:** In event of any error, please turn off the unit and contact the professionally skilled personnel.

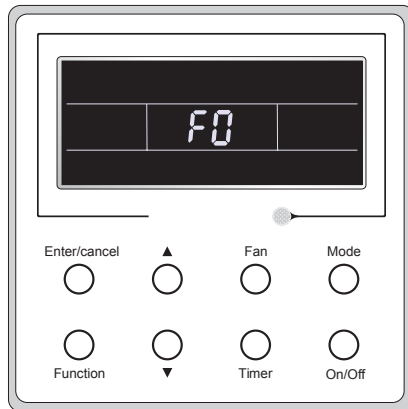

Fig.21

Table 4 Meaning of Each Error

Error	Error Code	Error	Error Code
Return air temperature sensor open/short circuited	F1	Drive board communication error	P6
evaporator temperature sensor open/short circuited	F2	Compressor overheating protection	H3
Indoor unit liquid valve temperature sensor open/short circuited	b5	Indoor and outdoor units unmatched	LP
Indoor gas valve temperature sensor open/short circuited	b7	Communication line misconnected or expansion valve error	dn
IPM temperature sensor open/short circuited	P7	Running mode conflict	E7
Outdoor ambient temperature sensor open/short circuited	F3	Pump-down	Fo
Outdoor unit condenser mid-tube temperature sensor open/short circuited	F4	Defrost or oil return	
Discharge temperature sensor open/short circuited	F5	Forced defrosting	H1
Indoor and outdoor communication error	E6	Compressor startup failure	Lc
DC bus under-voltage protection	PL	High discharge temperature protection	E4
DC bus over-voltage protection	PH	Overload protection	E8
Compressor phase current sensing circuit error	U1	Whole unit over-current protection	E5
Compressor demagnetization protection	HE	Over phase current protection	P5
PFC protection	Hc	Compressor desynchronizing	H7
IPM Temperature Protection	P8	IPM Current protection	H5
Over-power protection	L9	Compressor phase loss/reversal protection	Ld
System charge shortage or blockage protection	F0	Frequency restricted/reduced with whole unit current protection	F8
Capacitor charging error	PU	Frequency restricted/reduced with IPM current protection	En
High pressure protection	E1	Frequency restricted/reduced with high discharge temperature	F9
Low pressure protection	E3	Frequency restricted/reduced with anti-freezing protection	FH
Compressor stalling	LE	Frequency restricted/reduced with overload protection	F6
Over-speeding	LF	Frequency restricted/reduced with IPM temperature protection	EU
Drive board temperature sensor error	PF	Indoor unit full water error	E9
AC contactor protection	P9	Anti-freezing protection	E2
Temperature drift protection	PE	AC input voltage abnormal	PP
Sensor connection protection	Pd	Whole unit current sensing circuit error	U5
DC bus voltage drop error	U3	4-way valve reversing error	U7
Outdoor fan 1 error protection	L3	Motor stalling	H6
Outdoor fan 2 error protection	LA	PG motor zero-crossing protection	U8



---

<b>Error</b>	<b>Error Code</b>	<b>Error</b>	<b>Error Code</b>
Compressor inhalation temperature sensor error	dc	Indoor fan tripping error	U0
Communication error between IDU and grid connection	Ln	IDU network address error	y3
Communication error between ODU and grid connection	LM	Ip address allocation overflow	yb
Main error at grid connection side	y2		

## II Wireless Remote Controller YT1F

Notes:

- ① . Be sure that there are no obstructions between the receiver and the remote controller;
- ② . Do not drop or throw the remote controller;
- ③ . Do not let any liquid into the remote controller and expose the remote controller to direct sunlight or any place where is very hot.
- ④ . This is a general use remote controller. If press some button which is not available for the corresponding function, the unit will keep the original running status.

### 1 Function of Press Buttons



Fig.22

#### 1) ON/OFF (🔌)

Press this button to turn on/off the unit. After that, the sleep function will be canceled but the preset time is still remained.

#### 2) MODE

Auto, Cool, Dry, Fan, Heat modes can be selected circularly by pressing this button. Auto mode is the default after power on. Under Auto mode, the temperature will not be displayed. Under Heat mode, the initial value is 28°C (82 °F ); Under other modes, the initial value is 25°C (77 °F ).

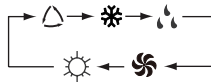

- △ Auto
- ❄️ Cool
- 💧 Dry
- 🌀 Fan
- ☀️ Heat(Only for the cooling and heating unit)

## 3) SLEEP





Sleep On and Sleep Off can be selected by pressing this button. After powered on, the default is Sleep Off. After the unit is turned off, the Sleep function is canceled. When the sleep function is set already, the symbol  will be displayed. And at this time, the time of timer can be adjusted. Under Fan and Auto modes, this function is not available.

## 4) FAN

Auto, Low, Medium, or High fan speed can circularly selected by pressing this button. After powered on, the default is Auto speed. Under Dehumidifying mode, only Low fan speed is available.



## 5) CLOCK

The clock can be set up by pressing this button, with the symbol  displayed and blinking. In such a case, pressing + or - within 5 seconds can adjust the value. If the button is pressed down for more than 2 seconds, the value on ten's place will increase by 1 in every 0.5 seconds. After that, repressing this button and then symbol  stops blinking, which indicates the setting is made successfully. After powered on, the default value is 12:00 with  displayed. Once the symbol  is displayed, the current time is the Clock value; otherwise it is the Timer value.

## 6) LIGHT

Light On and Light Off can be set by pressing this button when the unit is at On or Off status. After powered on, the default is Light On.

## 7) TURBO

In Cool or Heat mode, pressing this button can activate or deactivate this function. When this function is on, its symbol will be displayed. Any change of either mode or fan speed will make this function canceled automatically.

## 8) X-FAN

Pressing X-FAN button in COOL or DRY mode, the icon  is displayed and the indoor fan will continue operation for 10 minutes in order to dry the indoor unit even though you have turned off the unit.

After energization, X-FAN OFF is defaulted. X-FAN is not available in AUTO, FAN or HEAT mode.

## 9) -

The preset temperature can be decreased by pressing this button. If the button is pressed down for more than 2 seconds, the temperature will be decreased quickly until it is released, with  $^{\circ}\text{C}$  ( $^{\circ}\text{F}$ ) displayed at the time. Under Auto mode, the temperature adjustment is unavailable.

## 10) +

The preset temperature can be increased by pressing this button. If the button is pressed down for more than 2 seconds, the temperature will be increased quickly until it is released, with  $^{\circ}\text{C}$  ( $^{\circ}\text{F}$ ) displayed all the time. Under Auto mode, the temperature adjustment is unavailable. The setting range is 16-30  $^{\circ}\text{C}$  or 61-86  $^{\circ}\text{F}$

## 11) TEMP





It can be decided by pressing this button which temperature will be displayed, indoor set

temperature, or indoor ambient temperature. When the indoor unit is powered on, the indoor set temperature will be displayed, while if the status is changed to , the indoor ambient temperature will be displayed. However, the indoor set temperature will be displayed again when the controller receives other remote controls signals. Without setting this function, the default is the indoor set temperature.

## 12) SWING UP/DOWN

The swing angle which circularly changes as below can be selected by pressing this button:



This kind of remoter controller is universal. And the three swing statuses of , ,  are the same as that of .

If the swing function is deactivated when the air guide louver is swing up and down, it will stop at the current position.

 indicates that the air guide louver swings up and down among all five positions.

## 13) AIR

AIR ON or Air OFF can be selected by pressing this button.

## 14) TIMER ON

“ON” will be displayed and blink for 5 seconds by pressing this button, and soon adjust the time by pressing + or – within 5 seconds. Each press will make the time increased or decreased by 1 minute. If the button is pressed down for more than 2 seconds, the time will be changed quickly in such a way: firstly the value on the one’s place is changed and then is the value on the ten’s place. Once Timer ON has been set already, it can be canceled by repressing it. Before the setting, please adjust the CLOCK to the current actual time.

## 15) TIMER OFF

TIME OFF can be activated by pressing this button, with “OFF” blinking. The method of setting is the same as that for TIMER ON.

## 16) HEALTH

This function can be activated or deactivated by pressing this button. After the unit is turned on, the default is HEALTH ON.

## 17) I FEEL

This function can be activated by pressing this button and canceled by another press. When this function is on, the I FEEL information will be sent out in 200ms after each operation on the controller and the remote controller will send the temperature information to the main controller every 10 minutes.

## 2 Guide for General Operation

- a. After powered on, press ON/OFF and then the unit will start to run. (Note: when powered off, the guide louver of the main unit will close automatically).
- b. Press MODE to select the desired running mode.
- c. Press + or – to set the desired temperature (it is unnecessary to set the temperature under the AUTO mode.)

d. Press FAN to set the fan speed, Auto, Low, Medium, or High.

e. Press  to select the swing angle.

### 3 Guide for Optional Operation

#### a. About X-FAN

This function indicates that moisture in the evaporator of the indoor unit will be dried after the unit is stopped to avoid mould.

① . X-FAN ON: When press the ON/OFF button to turn off the unit, the indoor fan will continue running for about another 10 minutes at the low speed. In this case, the indoor fan can be stopped directly by pressing the button X-FAN.

② . X-FAN OFF: When press the ON/OFF button to turn off the unit, the whole unit will be stopped completely.

#### b. About AFTERHEAT X-FAN

Under the Heat mode or Auto Heat mode, if the unit is turned off, the compressor and outdoor fan will stop running immediately and the upper and lower guide board will rotate to the horizontal position, while the indoor fan will still run at the low fan speed. Then, 10 seconds later, the unit will stop completely.

#### c. About AUTO RUN

When AUTO RUN is selected, the setting temperature will not be displayed on the LCD and the unit will choose the suitable running mode automatically in accordance with the room temperature.

#### d. About TURBO

If this function is activated, the unit will run at super-high fan speed to cool or heat quickly so that the ambient temperature will approaches the preset temperature as soon as possible.

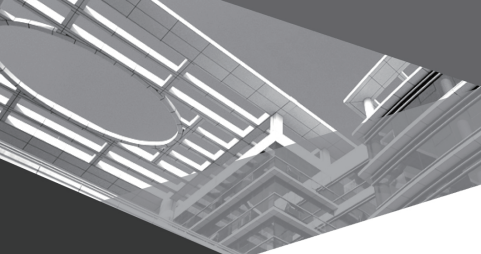

**GREE ELECTRIC APPLIANCES, INC. OF ZHUHAI**

Add: West Jinji Rd, Qianshan, Zhuhai, Guangdong, China, 519070

Tel: (+86-756) 8522218

Fax: (+86-756) 8669426

E-mail: [gree@gree.com.cn](mailto:gree@gree.com.cn) [www.gree.com](http://www.gree.com)

GREE\_XK19\_OWNERS\_01082021



66174339