



# **Installation Manual**

**Original Instructions** Split Air

Conditioner

## **CONTENTS**

---

Safety precautions .....	01
Parts name .....	05
Installation notice .....	06
Installation of outdoor unit .....	08
Test and operation .....	10
Configuration of connection pipe .....	11

---

Thank you for choosing our product.  
Please read this Installation Manual carefully before operation and retain it for future reference.  
If you have lost the Installation Manual, please contact the local agent or visit [www.gree.com](http://www.gree.com) or send an email to [global@cn.gree.com](mailto:global@cn.gree.com) for the electronic version.

**NOTE:**

**Actual product may be different from graphics, please refer to actual products.**

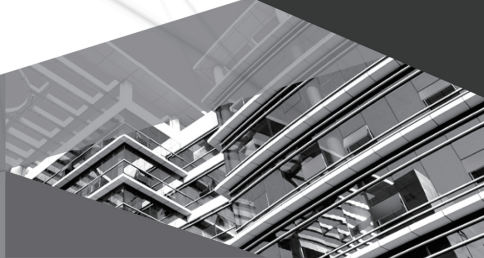



4LIV09HP115V1AO  
4LIV12HP115V1AO  
4LIV09HP230V1AO  
4LIV12HP230V1AO  
4LIV18HP230V1AO  
4LIV24HP230V1AO  
4LIV30HP230V1AO  
4LIV36HP230V1AO

## Explanation of Symbols



### **WARNING**

This symbol indicates the possibility of death or serious injury.



### **CAUTION**

This symbol indicates the possibility of injury or damage to property.

### **NOTICE**

Indicates important but not hazard-related information, used to indicate risk of property damage.

## Exception Clauses

Manufacturer will bear no responsibilities when personal injury or property loss is caused by the following reasons.

1. Damage the product due to improper use or misuse of the product;
2. Alter, change, maintain or use the product with other equipment without abiding by the instruction manual of manufacturer;
3. After verification, the defect of product is directly caused by corrosive gas;
4. After verification, the defects are due to improper operation during transportation of product;
5. Operate, repair, maintain the unit without abiding by instruction manual or related regulations;
6. After verification, the problem or dispute is caused by the quality specification or performance of parts and components that produced by other manufacturers;
7. The damage is caused by natural calamities, bad using environment or force majeure.

If it needs to install, move or maintain the air conditioner, please contact dealer or local service center to conduct it at first. Air conditioner must be installed, moved or maintained by appointed unit. Otherwise, it may cause serious damage or personal injury or death.

When refrigerant leaks or requires discharge during installation, maintenance, or disassembly, it should be handled by certified professionals or otherwise in compliance with local laws and regulations.

This appliance is not intended for use by persons (including children) with reduced physical, sensory or mental capabilities or lack of experience and knowledge, unless they have been given supervision or instruction concerning use of the appliance by a person responsible for their safety.

Children should be supervised to ensure that they do not play with the appliance.

## **FCC WARNING**

**WARNING:** Changes or modifications to this unit not expressly approved by the party responsible for compliance could void the user's authority to operate the equipment.

## **FCC STATEMENT**

This device complies with Part 15 of the FCC Rules. Operation is subject to the following two conditions :

(1) this device may not cause harmful interference, and (2) this device must accept any interference received, including interference that may cause undesired operation.

**NOTE:** This equipment has been tested and found to comply with the limits for a Class B digital device, pursuant to part 15 of the FCC Rules. These limits are designed to provide reasonable protection against harmful interference in a residential installation. This equipment generates, uses and can radiate radio frequency energy and, if not installed and used in accordance with the instructions, may cause harmful interference to radio communications.

However, there is no guarantee that interference will not occur in a particular installation. If this equipment does cause harmful interference to radio or television reception, which can be determined by turning the equipment off and on, the user is encouraged to try to correct the interference by one or more of the following measures:

- Reorient or relocate the receiving antenna.
- Increase the separation between the equipment and receiver.
- Connect the equipment into an outlet on a circuit different from that to which the receiver is connected.
- Consult the dealer or an experienced radio/TV technician for help.

## **IC STATEMENT**

This device complies with Industry Canada licence exempt RSS standard(s). Operation is subject to the following two conditions: (1) this device may not cause interference, and (2) this device must accept any interference, including interference that may cause undesired operation of the device.

Le présent appareil est conforme aux CNR d'Industrie Canada applicables aux appareils radio exempts de licence. L'exploitation est autorisée aux deux conditions suivantes : (1) l'appareil ne doit pas produire de brouillage, et (2) l'utilisateur de l'appareil doit accepter tout brouillage radioélectrique subi, même si le brouillage est susceptible d'en compromettre le fonctionnement.

## IC STATEMENT

This equipment complies with FCC's and IC's RF radiation exposure limits set forth for an uncontrolled environment. The antenna(s) used for this transmitter must be installed and operated to provide a separation distance of at least 20 cm from all persons and must not be collocated or operating in conjunction with any other antenna or transmitter. Installers must ensure that 20cm separation distance will be maintained between the device (excluding its handset) and users.

Cet appareil est conforme aux limites d'exposition au rayonnement RF stipulées par la FCC et l'IC pour une utilisation dans un environnement non contrôlé. Les antennes utilisées pour cet émetteur doivent être installées et doivent fonctionner à au moins 20 cm de distance des utilisateurs et ne doivent pas être placées près d'autres antennes ou émetteurs ou fonctionner avec ceux-ci. Les installateurs doivent s'assurer qu'une distance de 20 cm sépare l'appareil (à l'exception du combiné) des utilisateurs.

# Safety precautions

---



## WARNING

### Installation

- Installation or maintenance must be performed by qualified professionals.
- The appliance shall be installed in accordance with national wiring regulations.
- According to the local safety regulations, use qualified power supply circuit and circuit breaker.
- All wires of indoor unit and outdoor unit should be connected by a professional.
- Be sure to cut off the power supply before proceeding any work related to electricity and safety.
- Make sure the power supply matches with the requirement of air conditioner.
- Unstable power supply or incorrect wiring may result in electric shock, fire hazard or malfunction. Please install proper power supply cables before using the air conditioner.
- The grounding resistance should comply with national electric safety regulations.
- Air Conditioner should be properly grounded. Incorrect grounding may cause electric shock.
- Do not put through the power before finishing installation.
- Do install the circuit breaker. If not, it may cause malfunction.
- An all-pole disconnection switch having a contact separation of at least 3mm in all poles should be connected in fixed wiring.
- Circuit breaker should be included magnet buckle and heating buckle function. It can protect the overload and circuit-short.

# Safety precautions

---



## CAUTION

### Installation

- Instructions for installation and use of this product are provided by the manufacturer.
- Select a location which is out of reach for children and far away from animals or plants. If it is unavoidable, please add the fence for safety purpose.
- The indoor unit should be installed close to the wall.
- Don't use unqualified power cord.
- If the length of power connection wire is insufficient, please contact the supplier for a new one.
- The appliance must be positioned so that the plug is accessible.
- For the air conditioner with plug, the plug should be reachable after finishing installation.
- For the air conditioner without plug, a circuit breaker must be installed in the line.
- The yellow-green wire in air conditioner is grounding wire, which can't be used for other purposes.
- The air conditioner is the first class electric appliance. It must be properly grounded with specialized grounding device by a professional. Please make sure it is always grounded effectively, otherwise it may cause electric shock.
- The temperature of refrigerant circuit will be high, please keep the interconnection cable away from the copper tube.



# Safety precautions

---



## WARNING

### Operation and Maintenance

- This appliance can be used by children aged from 8 years and above and persons with reduced physical, sensory or mental capabilities or lack of experience and knowledge if they have been given supervision or instruction concerning use of the appliance in a safe way and understand the hazards involved.
- Children shall not play with the appliance.
- Cleaning and user maintenance shall not be made by children without supervision.
- If the supply cord is damaged, it must be replaced by the manufacturer, its service agent or similarly qualified persons in order to avoid a hazard.
- Do not connect air conditioner to multi-purpose socket. Otherwise, it may cause fire hazard.
- Do not disconnect power supply when cleaning air conditioner. Otherwise, it may cause electric shock.
- Do not wash the air conditioner with water to avoid electric shock.
- Do not spray water on indoor unit. It may cause electric shock or malfunction.
- Do not repair air conditioner by yourself. It may cause electric shock or damage. Please contact dealer when you need to repair air conditioner.
- After removing the filter, do not touch fins to avoid injury.
- Do not extend fingers or objects into air inlet or air outlet. It may cause personal injury or damage.

# Safety precautions

---



## CAUTION

### Operation and Maintenance

- Do not spill water on the remote controller, otherwise the remote controller may be broken.
- Do not use fire or hair dryer to dry the filter to avoid deformation or fire hazard.
- Do not block air outlet or air inlet. It may cause malfunction.
- Do not step on top panel of outdoor unit, or put heavy objects. It may cause damage or personal injury.
- When below phenomenon occurs, please turn off air conditioner and disconnect power immediately, and then contact the dealer or qualified professionals for service.
  - Power cord is overheating or damaged.
  - There's abnormal sound during operation.
  - Circuit breaker trips off frequently.
- Air conditioner gives off burning smell.
- Indoor unit is leaking.

## Parts name

---

### Outdoor Unit

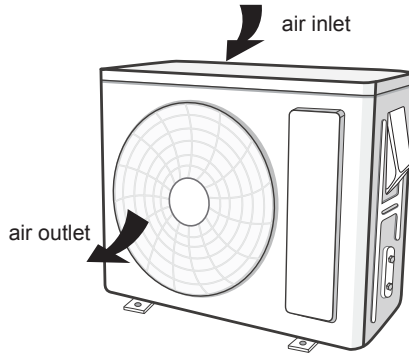

### NOTE

- Actual product may be different from above graphics, please refer to actual product.

# Installation notice

Wall Mounting Clearances

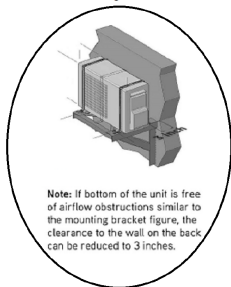

Slab Mounting Clearances

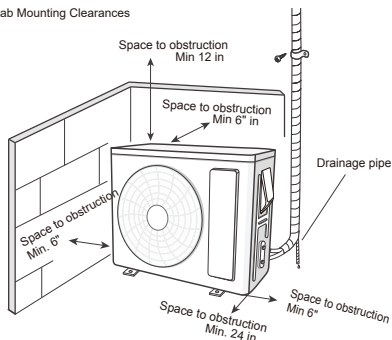

## ■ Safety precautions for installing and relocating the unit

To ensure safety, please be mindful of the following precautions.

### ⚠ WARNING

- **When installing or relocating the unit, be sure to keep the refrigerant circuit free from air or substances other than the specified refrigerant.**

Any presence of air or other foreign substance in the refrigerant circuit will cause system pressure rise or compressor rupture, resulting in injury.

- **When installing or moving this unit, do not charge the refrigerant which is not comply with that on the nameplate or unqualified refrigerant.**

Otherwise, it may cause abnormal operation, wrong action, mechanical malfunction or even serious safety accident.

- **When refrigerant needs to be recovered during relocating or repairing the unit, be**

### ⚠ WARNING

sure that the unit is running in cooling mode. Then, fully close the valve at high pressure side (liquid valve). About 30-40 seconds later, fully close the valve at low pressure side (gas valve), immediately stop the unit and disconnect power. Please note that the time for refrigerant recovery should not exceed 1 minute.

If refrigerant recovery takes too much time, air may be sucked in and cause pressure rise or compressor rupture, resulting in injury.

- **During refrigerant recovery, make sure that liquid valve and gas valve are fully closed and power is disconnected before detaching the connection pipe.**

If compressor starts running when stop valve is open and connection pipe is not yet connected, air will be sucked in and cause pressure rise or compressor rupture, resulting in injury.

- **When installing the unit, make sure that connection pipe is securely connected before the compressor starts running.**

If compressor starts running when stop valve is open and connection pipe is not yet connected, air will be sucked in and cause pressure rise or compressor rupture, resulting in injury.

- **Prohibit installing the unit at the place where there may be leaked corrosive gas or flammable gas.**

If there is leaked gas around the unit, it may cause explosion and other accidents.

- **Do not use extension cords for electrical connections. If the electric wire is not long enough, please contact a local service center authorized and ask for a proper electric wire.**

Poor connections may lead to electric shock or fire.

- **Use the specified types of wires for electrical connections between the indoor and outdoor units. Firmly clamp the wires so that their terminals receive no external stresses.**

Electric wires with insufficient capacity, wrong wire connections and insecure wire terminals may cause electric shock or fire.

## ■ Tools for installation

- |                 |                    |                         |
|-----------------|--------------------|-------------------------|
| ① Level meter   | ⑦ Open-end wrench  | ⑫ Universal meter       |
| ② Screw driver  | ⑧ Pipe cutter      | ⑬ Inner hexagon spanner |
| ③ Impact drill  | ⑨ Leakage detector | ⑭ Measuring tape        |
| ④ Drill head    | ⑩ Vacuum pump      |                         |
| ⑤ Pipe expander | ⑪ Pressure meter   |                         |
| ⑥ Torque wrench |                    |                         |

### NOTICE

- Please contact the local agent for installation.
- Don't use unqualified power cord.

## ■ Selection of installation location

### **Basic requirement**

Installing the unit in the following places may cause malfunction. If it is unavoidable, please consult the local dealer:

1. The place with strong heat sources, vapors, flammable or explosive gas, or volatile objects spread in the air.
2. The place with high-frequency devices (such as welding machine, medical equipment).
3. The place near coast area.
4. The place with oil or fumes in the air.
5. The place with sulfureted gas.
6. Other places with special circumstances.
7. The appliance shall not be installed in the laundry.
8. It's not allowed to be installed on the unstable or motive base structure (such as truck) or in the corrosive environment (such as chemical factory).

### **Outdoor unit**

1. Select a location where the noise and outflow air emitted by the outdoor unit will not affect neighborhood.
2. The location should be well ventilated and dry, in which the outdoor unit won't be exposed directly to sunlight or strong wind.
3. The location should be able to withstand the weight of outdoor unit.
4. Make sure that the installation follows the requirement of installation dimension diagram.
5. Select a location which is out of reach for children and far away from animals or plants. If it is unavoidable, please add the fence for safety purpose.

### **Safety precaution**

1. Must follow the electric safety regulations when installing the unit.
2. According to the local safety regulations, use qualified power supply circuit and air switch.
3. Make sure the power supply matches with the requirement of air conditioner. Unstable power supply or incorrect wiring or malfunction. Please install proper power supply cables before using the air conditioner.
4. Properly connect the live wire, neutral wire and grounding wire of power socket.
5. Be sure to cut off the power supply before proceeding any work related to electricity and safety.
6. Do not put through the power before finishing installation.
7. If the supply cord is damaged, it must be replaced by the manufacturer, its service agent or similarly qualified persons in order to avoid a hazard.

## ■ Requirements for electric connection

8. The temperature of refrigerant circuit will be high, please keep the interconnection cable away from the copper tube.
9. The appliance shall be installed in accordance with national wiring regulations.

### **Grounding requirement**

1. The air conditioner is the first class electric appliance. It must be properly grounded with specialized grounding device by a professional. Please make sure it is always grounded effectively, otherwise it may cause electric shock.
2. The yellow-green wire in air conditioner is grounding wire, which can't be used for other purposes.
3. The grounding resistance should comply with national electric safety regulations.
4. The appliance must be positioned so that the plug is accessible.
5. An all-pole disconnection switch having a contact separation of at least 3mm in all poles should be connected in fixed wiring.

# Installation of outdoor unit

## Step 1:

### Fix the support of outdoor unit (select it according to the actual installation situation)

1. Select installation location according to the house structure.
2. Fix the support of outdoor unit on the selected location with expansion screws.

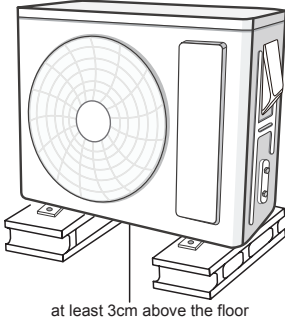

#### NOTICE

- Take sufficient protective measures when installing the outdoor unit.
- Make sure the support can withstand at least four times of the unit weight.
- The outdoor unit should be installed at least 3cm above the floor in order to install drain joint. (for the model with heating tube, the installation height should be no less than 20cm.)
- For the unit with cooling capacity of 2300W~5000W, 6 expansion screws are needed; for the unit with cooling capacity of 6000W~8000W, 8 expansion screws are needed; for the unit with cooling capacity of 10000W~16000W, 10 expansion screws are needed.

## Step 2: Install drain joint (only for some models)

1. Connect the outdoor drain joint into the hole on the chassis, as shown in the picture below.
2. Connect the drain hose into the drain vent.

#### NOTICE

- As for the shape of drainage joint, please refer to the current product. Do not install the drainage joint in the severe cold area. Otherwise, it will be frosted and then cause malfunction.

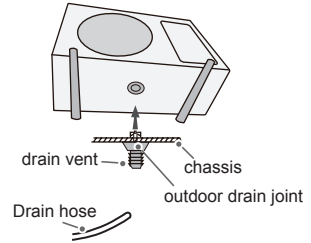

## Step 3: Fix outdoor unit

1. Place the outdoor unit on the support.
2. Fix the foot holes of outdoor unit with bolts.

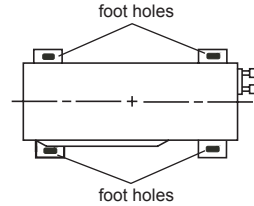

## Step 4: Connect indoor and outdoor pipes

1. Remove the screw on the right handle of outdoor unit and then remove the handle.

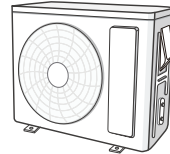

2. Remove the screw cap of valve and aim the pipe joint at the bellmouth of pipe.

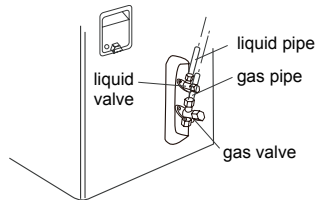

3. Pretighten the union nut with hand.

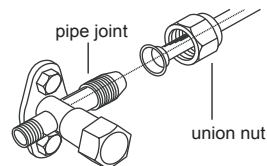

4. Tighten the union nut with torque wrench by referring to the sheet below.

Hex nut diameter	Tightening torque(N·m)
1/4"	15~20
3/8"	30~40
1/2"	45~55
5/8"	60~65
3/4"	70~75

## Step 5:

### Connect outdoor electric wire

1. Remove the wire clip; connect the power connection wire and signal control wire (only for cooling and heating unit) to the wiring terminal according to the color; fix them with screws.

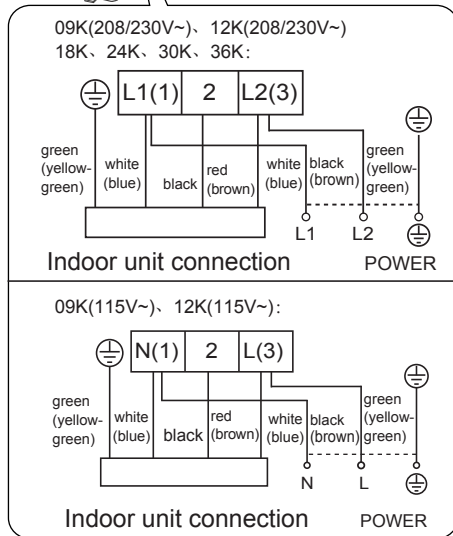
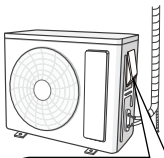

#### NOTICE

- The wiring board is for reference only, please refer to the actual one.

2. Fix the power connection wire and signal control wire with wire clip (only for cooling and heating unit).

#### NOTICE

- After tighten the screw, pull the power cord slightly to check if it is firm.
- Never cut the power connection wire to prolong or shorten the distance.

## Step 6: Neaten the pipes

- The pipes should be placed along the wall, bent reasonably and hidden possibly. Min. semidiameter of bending the pipe is 10cm.
- If the outdoor unit is higher than the wall hole, you must set a U-shaped curve in the pipe before pipe goes into the room, in order to prevent rain from getting into the room.

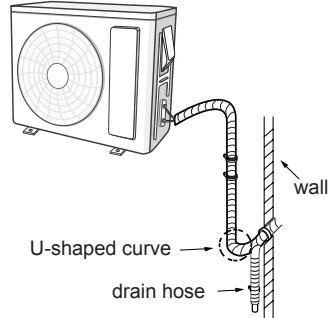

#### NOTICE

- The through-wall height of drain hose should not be higher than the outlet pipe hole of indoor unit.

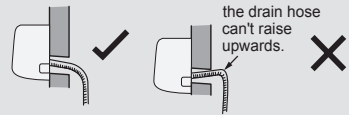

- The water outlet can't be placed in water in order to drain smoothly.

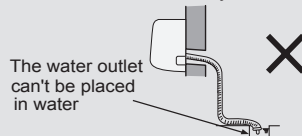

- Slant the drain hose slightly downwards. The drain hose can't be curved, raised and fluctuant, etc.

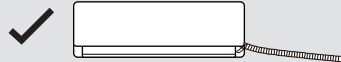

- The drain hose can't be fluctuant

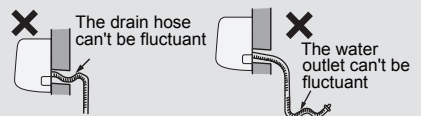

## Test and operation

### Use vacuum pump

1. Remove the valve caps on the liquid valve and gas valve and the nut of refrigerant charging vent.
2. Connect the charging hose of piezometer to the refrigerant charging vent of gas valve and then connect the other charging hose to the vacuum pump.
3. Open the piezometer completely and operate for 10-15min to check if the pressure of piezometer remains in -0.1MPa.
4. Close the vacuum pump and maintain this status for 1-2min to check if the pressure of piezometer remains in -0.1MPa. If the pressure decreases, there may be leakage.
5. Remove the piezometer, open the valve core of liquid valve and gas valve completely with inner hexagon spanner.
6. Tighten the screw caps of valves and refrigerant charging vent.
7. Reinstall the handle.

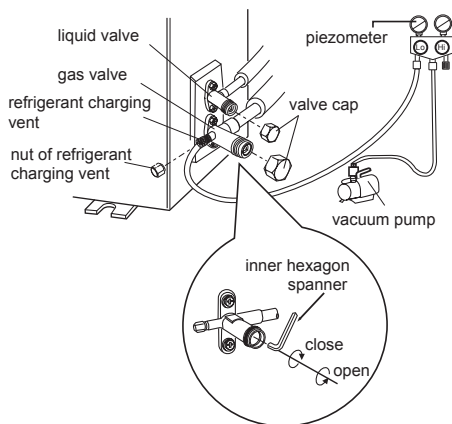

### Leakage detection

1. With leakage detector:  
Check if there is leakage with leakage detector.
2. With soap water:  
If leakage detector is not available, please use soap water for leakage detection. Apply soap water at the suspected position and keep the soap water for more than 3min. If there are air bubbles coming out of this position, there's a leakage.

### Check after installation

- Check according to the following requirement after finishing installation.

Items to be checked	Possible malfunction
Has the unit been installed firmly?	The unit may drop, shake or emit noise.
Have you done the refrigerant leakage test?	It may cause insufficient cooling(heating) capacity.
Is heat insulation of pipeline sufficient?	It may cause condensation and water dripping.
Is water drained well?	It may cause condensation and water dripping.
Is the voltage of power supply according to the voltage marked on the nameplate?	It may cause malfunction or damage the parts.
Is electric wiring and pipeline installed correctly?	It may cause malfunction or damage the parts.
Is the unit grounded securely?	It may cause electric leakage.
Does the power cord follow the specification?	It may cause malfunction or damage the parts.
Is there any obstruction in the air inlet and outlet?	It may cause insufficient cooling(heating) capacity.
The dust and sundries caused during installation are removed?	It may cause malfunction or damage the parts.
The gas valve and liquid valve of connection pipe are open completely?	It may cause insufficient cooling (heating) capacity.
Is the inlet and outlet of piping hole been covered?	It may cause insufficient cooling (heating) capacity or waste electricity.

### Test operation

#### 1. Preparation of test operation

- The client approves the air conditioner.
- Specify the important notes for air conditioner to the client.

#### 2. Method of test operation

- Put through the power, press ON/OFF button on the remote controller to start operation.
- Press MODE button to select AUTO, COOL, DRY, FAN and HEAT to check whether the operation is normal or not.
- If the ambient temperature is lower than 16℃, the air conditioner can't start cooling.



## Configuration of connection pipe

1. Standard length of connection pipe: 5m, 7.5m, 8m.
2. Min. length of connection pipe is 3m.
3. Max. length of connection pipe is shown as below.

### Max. length of connection pipe

Cooling capacity	Max. length of connection pipe(ft)
5000 Btu/h (1465W)	49
7000 Btu/h (2051W)	49
9000 Btu/h (2637W)	49
12000 Btu/h (3516W)	66
18000 Btu/h (5274W)	82
24000 Btu/h (7032W)	82
28000 Btu/h (8204W)	98
36000 Btu/h (10548W)	98
42000 Btu/h (12306W)	98
48000 Btu/h (14064W)	98

4. The additional refrigerant oil and refrigerant charging required after prolonging connection pipe.

- After the length of connection pipe is prolonged for 10m at the basis of standard length, you should add 5ml of refrigerant oil for each additional 5m of connection pipe.
- The calculation method of additional refrigerant charging amount(on the basis of liquid pipe):  
Additional refrigerant charging amount = prolonged length of liquid pipe × additional refrigerant charging amount per meter
- Basing on the length of standard pipe, add refrigerant according to the requirement as shown in the table. The additional refrigerant charging amount per meter is different according to the diameter of liquid pipe. See the following sheet.

## Additional refrigerant charging amount for R22, R407C, R410A and R134a

Outdoor unit throttle	Cooling and heating(g/m)	20	50	120	120	250	350
	Cooling only(g/m)	15	15	30	60	250	350
Piping size	Gas pipe	3/8" or 1/2"	5/8" or 3/4"	3/4" or 7/8"	1" or 1 1/4"	-	-
	Liquid pipe	1/4"	1/4" or 3/8"	1/2"	5/8"	3/4"	7/8"

## Pipe expanding method

### NOTICE

Improper pipe expanding is the main cause of refrigerant leakage. Please expand the pipe according to the following steps:

### A: Cut the pipe

- Confirm the pipe length according to the distance of indoor unit and outdoor unit.
- Cut the required pipe with pipe cutter.

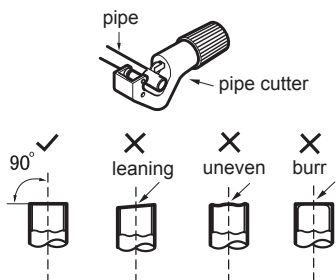

## B: Remove the burrs

- Remove the burrs with shaper and prevent the burrs from getting into the pipe.

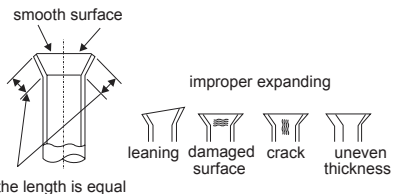
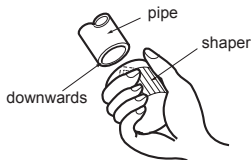

## C: Put on suitable insulating pipe

## D: Put on the union nut

- Remove the union nut on the indoor connection pipe and outdoor valve; install the union nut on the pipe.

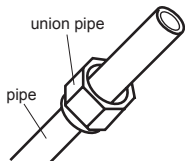

## E: Expand the port

- Expand the port with expander.

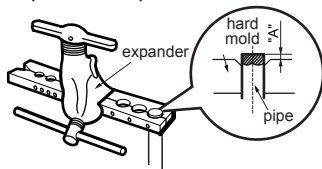

### NOTICE

- "A" is different according to the diameter, please refer to the sheet below:

Outer diameter (mm)	A(mm)	
	Max	Min
Φ6 - 6.35(1/4")	1.3	0.7
Φ9 - 9.52(3/8")	1.6	1.0
Φ12-12.7(1/2")	1.8	1.0
Φ15.8-16(5/8")	2.4	2.2

## F: Inspection

- Check the quality of expanding port. If there is any blemish, expand the port again according to the steps above.

## Working temperature range

	Indoor side DB/WB(°C /°F)	Outdoor side DB/WB(°C /°F)
Maximum cooling	26.7/19.4 (80/67)	46/24 (115/75)

09K/12K/18K/24K(For some model):

### NOTE

- The operating temperature range (outdoor temperature) for cooling is -18°C (0°F) ~ 46°C(115°F).

	Indoor side DB/WB(°C /°F)	Outdoor side DB/WB(°C /°F)
Maximum cooling	26.7/19.4 (80/67)	50/24 (122/75)

09K(For some model):

### NOTE

- The operating temperature range (outdoor temperature) for cooling is -25°C (-13°F) ~ 50°C(122°F).

24K(For some model):

### NOTE

- The operating temperature range (outdoor temperature) for cooling is -18°C(0°F) ~ 50°C(122°F).

	Indoor side DB/WB( C /°F)	Outdoor side DB/WB( C /°F)
Maximum cooling	26.7/19.4 (80/67)	50/24 (122/75)
Maximum heating	26.7/- (80/-)	30/18 (86/65)

09K/12K(For some model):

### NOTE

- The operating temperature range (outdoor temperature) for cooling is -20°C(-4°F)~50°C(122°F); for heat pump unit is -30°C(-22°F) ~ 50°C(122°F).

09K/12K/18K/24K(For some model):

### NOTE

- The operating temperature range (outdoor temperature) for cooling is -29°C(-20°F)~50°C(122°F); for heat pump unit is -30°C(-22°F) ~ 50°C(122°F).

09K(For some model):

	Indoor side DB/WB( C/°F)	Outdoor side DB/WB( C/°F)
Maximum cooling	26.7/19.4 (80/67)	48/23.9 (118/75)
Maximum heating	26.7/- (80/-)	24/18.3 (75/65)

**NOTE**

- The operating temperature range (outdoor temperature) for cooling is -18°C(0°F)~48°C(118°F); for heat pump unit is -20°C(-4°F) ~ 48°C(118°F).

24K(For some model):

	Indoor side DB/WB( C/°F)	Outdoor side DB/WB( C/°F)
Maximum cooling	26.7/19.4 (80/67)	50/24 (122/75)
Maximum heating	26.7/- (80/-)	24/18 (75/65)

**NOTE**

- The operating temperature range (outdoor temperature) for cooling is -18°C(0°F)~50°C(122°F); for heat pump unit is -25°C(-13°F) ~ 50°C(122°F).

09K/12K(For some model):

	Indoor side DB/WB( C/°F)	Outdoor side DB/WB( C/°F)
Maximum cooling	26.7/19.4 (80/67)	46/23.9 (115/75)
Maximum heating	26.7/- (80/-)	24/18.3 (75/65)

**NOTE**

- The operating temperature range (outdoor temperature) for cooling is -18°C(0°F)~46°C(115°F); for heat pump unit is -20°C(-4°F) ~ 46°C(115°F).

24K(For some model):

	Indoor side DB/WB( C/°F)	Outdoor side DB/WB( C/°F)
Maximum cooling	26.7/19.4 (80/67)	50/24 (122/75)
Maximum heating	26.7/- (80/-)	24/18 (75/65)

**NOTE**

- The operating temperature range (outdoor temperature) for cooling is -20°C (-4°F) ~ 50°C (122°F); for heat pump unit is -25°C (-13°F) ~ 50°C (122°F).

18K(For some model):

	Indoor side DB/WB( C/°F)	Outdoor side DB/WB( C/°F)
Maximum cooling	26.7/19.4 (80/67)	46/23.9 (115/75)
Maximum heating	26.7/- (80/-)	24/18.3 (75/65)

**NOTE**

- The operating temperature range (outdoor temperature) for cooling is -18°C(0°F)~46°C(115°F); for heat pump unit is -25°C(-13°F) ~ 46°C(115°F).

30K、36K(For some model):

	Indoor side DB/WB( C/°F)	Outdoor side DB/WB( C/°F)
Maximum cooling	26.7/19.4 (80/67)	46/24 (115/75)
Maximum heating	26.7/- (80/-)	24/18 (75/65)

**NOTE**

- The operating temperature range (outdoor temperature) for cooling is -20°C(-4°F)~46°C(115°F); for heat pump unit is -25°C(-13°F) ~ 46°C(115°F).



U.S. CONTACT INFORMATION  
TRADEWINDS, LLC

[www.greecomfort.com/resources](http://www.greecomfort.com/resources)  
E-mail: [info@twclimate.com](mailto:info@twclimate.com)  
Contractor Support 888-850-7928 | Mon-Fri 8AM-5PM EDT



GREE ELECTRIC APPLIANCES, INC. OF ZHUHAI

Add: West Jinji Rd, Qianshan, Zhuhai, Guangdong, China, 519070  
Tel: (+86-756) 8522218  
Fax: (+86-756) 8669426  
E-mail: [gree@gree.com.cn](mailto:gree@gree.com.cn) [www.gree.com](http://www.gree.com)

CAT NO: GREE\_4LIV\_AO\_INSTALL\_03012023



66139904161