



Service Manual

Models: GWC09QB-D3DNA6E(LC)
GWH09QB-D3DNA6E(LCLH)
GWC12QC-D3DNA6E(LC)
GWH12QC-D3DNA6E(LCLH)
(Refrigerant R410A)

Table of Contents

Part I : Technical Information	1
1. Summary	1
2. Specifications	2
2.1 Specification Sheet.....	2
2.2 Operation Characteristic Curve	6
2.3 Capacity Variation Ratio According to Temperature	6
2.4 Cooling and Heating Data Sheet in Rated Frequency	7
2.5 Noise Curve.....	7
3. Outline Dimension Diagram	8
3.1 Indoor Unit.....	8
3.2 Outdoor Unit.....	9
4. Refrigerant System Diagram	10
5. Electrical Part	11
5.1 Wiring Diagram.....	11
5.2 PCB Printed Diagram	13
6. Function and Control	15
6.1 Remote Controller Introduction	15
6.2 Brief Description of Modes and Functions.....	19
Part II : Installation and Maintenance	28
7. Notes for Installation and Maintenance	28
8. Installation	30
8.1 Installation Dimension Diagram.....	30
8.2 Installation Parts-checking	32
8.3 Selection of Installation Location.....	32
8.4 Electric Connection Requirement	32
8.5 Installation of Indoor Unit.....	32
8.6 Installation of Outdoor Unit.....	35
8.7 Vacuum Pumping and Leak Detection	36
8.8 Check after Installation and Test Operation	36

9. Maintenance	37
9.1 Error Code List	37
9.2 Troubleshooting for Main Malfunction	38
9.3 Troubleshooting for Normal Malfunction.....	51
10. Exploded View and Parts List	53
10.1 Indoor Unit.....	53
10.2 Outdoor Unit	56
11. Removal Procedure	60
11.1 Removal Procedure of Indoor Unit	60
11.2 Removal Procedure of Outdoor Unit	65
Appendix:	70
Appendix 1: Reference Sheet of Celsius and Fahrenheit	70
Appendix 2: Configuration of Connection Pipe.....	70
Appendix 3: Pipe Expanding Method	71
Appendix 4: List of Resistance for Temperature Sensor	72

Part I : Technical Information

1. Summary

Indoor Unit

GWC09QB-D3DNA6E/(LC)
GWH09QB-D3DNA6E/(LCLH)
GWC12QC-D3DNA6E/(LC)
GWH12QC-D3DNA6E/(LCLH)

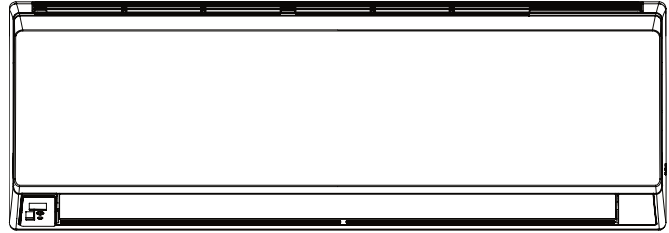

Outdoor Unit

GWC09QB-D3DNA6E/O
GWH09QB-D3DNA6E/O
GWC12QC-D3DNA6E/O
GWH12QC-D3DNA6E/O

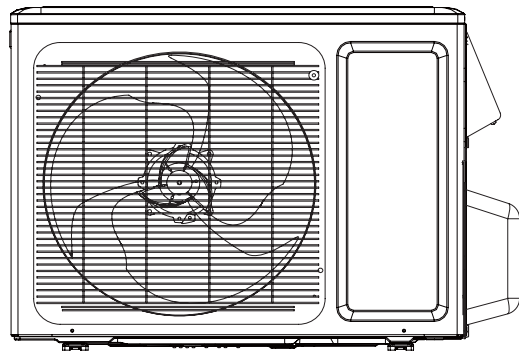

Remote Controller

YAN1F1F



2. Specifications

2.1 Specification Sheet

Model			GWC09QB-D3DNA6E(LC)	GWH09QB-D3DNA6E(LCLH)	
Product Code			CB427001900	CB427002200	
Power Supply	Rated Voltage	V~	208/230	208/230	
	Rated Frequency	Hz	60	60	
	Phases		1	1	
Power Supply Mode			Outdoor	Outdoor	
Cooling Capacity(Min~Max)		Btu/h	9000(3100~9600)	9000(3100~9600)	
Heating Capacity(Min~Max)		Btu/h	/	9500(3100~12000)	
Cooling Power Input(Min~Max)		W	900(375~1300)	900(375~1300)	
Heating Power Input(Min~Max)		W	/	800(300~1350)	
Cooling Power Current		A	4	4	
Heating Power Current		A	/	3.6	
Rated Input		W	1300	1350	
Rated Current		A	5.8	6.0	
Air Flow Volume(SH/H//ML)		CFM	318/288/241/171	318/288/241/171	
Dehumidifying Volume		Pint/h	1.69	1.69	
EER		(Btu/h)/ W	10.00	10.00	
COP		(Btu/h)/ W	/	11.88	
SEER			16.00	16.00	
HSPF			/	9.00	
Application Area		yd ²	14.35-21.53	14.35-21.53	
Indoor Unit	Model of indoor unit		GWC09QB-D3DNA6E/I	GWH09QB-D3DNA6E/I	
	Indoor Unit Product Code		CB427N01900	CB427N02200	
	Fan Type		Cross-flow	Cross-flow	
	Diameter Length(DXL)		inch	Φ3 6/7X22 5/6	Φ3 6/7X22 5/6
	Fan Motor Cooling Speed(SH/H//ML)		r/min	1350/1200/1050/750/-	1350/1200/1050/750/-
	Fan Motor Heating Speed(SH/H//ML)		r/min	/	1350/1200/1050/850/-
	Output of Fan Motor		W	20	20
	Fan Motor RLA		A	0.215	0.215
	Fan Motor Capacitor		μF	1	1
	Evaporator Form			Aluminum Fin-copper Tube	Aluminum Fin-copper Tube
	Pipe Diameter		inch	Φ1/5	Φ1/5
	Row-fin Gap		inch	2-1/16	2-1/16
	Coil Length (LXDXW)		inch	23X7/8X10 8/16	23X7/8X10 8/16
	Swing Motor Model			MP24AA	MP24AA
	Output of Swing Motor		W	1.5	1.5
	Fuse		A	3.15	3.15
	Sound Pressure Level(SH/H//ML)		dB (A)	43/38/34/28/-	43/38/34/28/-
	Sound Power Level(SH/H//ML)		dB (A)	53/48/44/38/-	53/48/44/38/-
	Dimension (WXHXD)		inch	31 1/9X10 5/6X7 7/8	31 1/9X10 5/6X7 7/8
	Dimension of Carton Box (LXWXH)		inch	34X10 5/9X13 6/7	34X10 5/9X13 6/7
	Dimension of Package (LXWXH)		inch	34X10 2/3X14 4/9	34X10 2/3X14 4/9
Net Weight		lb	19.8	19.8	
Gross Weight		lb	24.3	24.3	

Outdoor Unit	Model of Outdoor Unit		GWC09QB-D3DNA6E/O(LC)	GWH09QB-D3DNA6E/O(LCLH)
	Outdoor Unit Product Code		CB427W01900	CB427W02200
	Compressor Manufacturer/Trademark		ZHUHAI GREE DAIKIN DEVICE CO.,LTD	ZHUHAI GREE DAIKIN DEVICE CO.,LTD
	Compressor Model		1GDY23AXD	1GDY23AXD
	Compressor Oil		DAPHNE FVC50K	DAPHNE FVC50K
	Compressor Type		Swing	Swing
	Compressor Locked Rotor Amp (L.R.A)	A	/	/
	Compressor RLA	A	4.00	4.00
	Compressor Power Input	W	845	845
	Overload Protector		KSD115°C or HPC115/95	KSD115°C or HPC115/95
	Throttling Method		Capillary	Capillary
	Operation temp	°F	60.8~86	60.8~86
	Ambient temp (cooling)	°F	0~115	0~115
	Ambient temp (heating)	°F	-4~75	/
	Condenser Form		Aluminum Fin-copper Tube	Aluminum Fin-copper Tube
	Pipe Diameter	inch	Φ2/7	Φ2/7
	Rows-fin Gap	inch	1-1/18	1-1/18
	Coil Length (LXDXW)	inch	28X3/4X20	28X3/4X20
	Fan Motor Speed	rpm	820	820
	Output of Fan Motor	W	30	30
	Fan Motor RLA	A	0.36	0.36
	Fan Motor Capacitor	μF	/	/
	Air Flow Volume of Outdoor Unit	CFM	942	942
	Fan Type		Axial-flow	Axial-flow
	Fan Diameter	inch	Φ15 3/4	Φ15 3/4
	Defrosting Method		/	Automatic Defrosting
	Climate Type		T1	T1
	Isolation		I	I
	Moisture Protection		IP24	IP24
	Permissible Excessive Operating Pressure for the Discharge Side	MPa	4.3	4.3
	Permissible Excessive Operating Pressure for the Suction Side	MPa	2.5	2.5
	Sound Pressure Level (H/M/L)	dB (A)	52/-/-	52/-/-
	Sound Power Level (H/M/L)	dB (A)	62/-/-	62/-/-
Dimension (WXHXD)	inch	30 5/9X21 1/4X12 3/5	30 5/9X21 1/4X12 3/5	
Dimension of Carton Box (LXWXH)	inch	33 2/5X14 1/6X22 5/6	33 2/5X14 1/6X22 5/6	
Dimension of Package (LXWXH)	inch	33 1/2X14 2/7X23 3/7	33 1/2X14 2/7X23 3/7	
Net Weight	lb	66.2	65.0	
Gross Weight	lb	71.7	70.6	
Refrigerant		R410A	R410A	
Refrigerant Charge	oz	24.7	24.7	
Connection Pipe	Length	ft	24.6	24.6
	Gas Additional Charge	oz/ft	0.2	0.2
	Outer Diameter Liquid Pipe	inch	Φ1/4	Φ1/4
	Outer Diameter Gas Pipe	inch	Φ3/8	Φ3/8
	Max Distance Height	ft	32.8	32.8
	Max Distance Length	ft	49.2	49.2
	Note: The connection pipe applies metric diameter.			

The above data is subject to change without notice. Please refer to the nameplate of the unit.

Model			GWC12QC-D3DNA6E(LCLH)	GWH12QC-D3DNA6E(LCLH)
Product Code			CB427001800	CB427002100
Power Supply	Rated Voltage	V~	208/230	208/230
	Rated Frequency	Hz	60	60
	Phases		1	1
Power Supply Mode			Outdoor	Outdoor
Cooling Capacity(Min~Max)		Btu/h	12000(3753~12500)	12000(3753~12500)
Heating Capacity(Min~Max)		Btu/h	/	13000(3924~14000)
Cooling Power Input(Min~Max)		W	1300(410~1350)	1300(410~1350)
Heating Power Input(Min~Max)		W	/	1250(380~1500)
Cooling Power Current		A	5.8	5.8
Heating Power Current		A	/	5.6
Rated Input		W	1350	1500
Rated Current		A	5.8	6.7
Air Flow Volume(SH/H/M/L)		CFM	400/318/253/194	400/318/253/194
Dehumidifying Volume		Pint/h	2.96	2.96
EER		(Btu/h)/ W	9.23	9.23
COP		(Btu/h)/ W	/	10.40
SEER			16.00	16.00
HSPF			/	9.00
Application Area		yd ²	19.14-28.70	19.14-28.70
Indoor Unit	Model of indoor unit		GWC12QC-D3DNA6E/I	GWH12QC-D3DNA6E/I
	Indoor Unit Product Code		CB427N01800	CB427N02100
	Fan Type		Cross-flow	Cross-flow
	Diameter Length(DXL)		inch	Φ3 6/7X25
	Fan Motor Cooling Speed(SH/H/M/L)		r/min	1350/1200/1000/800/-
	Fan Motor Heating Speed(SH/H/M/L)		r/min	/
	Output of Fan Motor		W	20
	Fan Motor RLA		A	0.21
	Fan Motor Capacitor		μF	1.5
	Evaporator Form			Aluminum Fin-copper Tube
	Pipe Diameter		inch	Φ1/5
	Row-fin Gap		inch	2-1/18
	Coil Length (LXDXW)		inch	25X7/8X12 1/16
	Swing Motor Model			MP24BA
	Output of Swing Motor		W	1.5
	Fuse		A	3.15
	Sound Pressure Level(SH/H/M/L)		dB (A)	45/39/35/29/-
	Sound Power Level(SH/H/M/L)		dB (A)	55/49/45/39/-
	Dimension (WXHXD)		inch	33 1/4X11 3/8X8 2/9
	Dimension of Carton Box (LXWXH)		inch	36 1/7X11X14 1/3
Dimension of Package (LXWXH)		inch	36 1/4X11X15	
Net Weight		lb	23.2	
Gross Weight		lb	27.6	

Outdoor Unit	Model of Outdoor Unit		GWC12QC-D3DNA6E/O(LC)	GWH12QC-D3DNA6E/O(LCLH)
	Outdoor Unit Product Code		CB427W01800	CB427W02100
	Compressor Manufacturer/Trademark		ZHUHAI GREE DAIKIN DEVICE CO.,LTD	ZHUHAI GREE DAIKIN DEVICE CO.,LTD
	Compressor Model		1GDY23AXD	1GDY23AXD
	Compressor Oil		DAPHNE FVC50K	DAPHNE FVC50K
	Compressor Type		Swing	Swing
	Compressor Locked Rotor Amp (L.R.A)	A	/	/
	Compressor RLA	A	4.00	4.00
	Compressor Power Input	W	845	845
	Overload Protector		KSD115°C or HPC115/95	KSD115°C or HPC115/95
	Throttling Method		Capillary	Capillary
	Operation temp	°F	60.8~86	60.8~86
	Ambient temp (cooling)	°F	0~115	0~115
	Ambient temp (heating)	°F	-4~75	/
	Condenser Form		Aluminum Fin-copper Tube	Aluminum Fin-copper Tube
	Pipe Diameter	inch	Φ2/7	Φ2/7
	Rows-fin Gap	inch	2-1/18	2-1/18
	Coil Length (LXDXW)	inch	28X1 1/2X20	28X1 1/2X20
	Fan Motor Speed	rpm	820	820
	Output of Fan Motor	W	30	30
	Fan Motor RLA	A	0.36	0.36
	Fan Motor Capacitor	μF	/	/
	Air Flow Volume of Outdoor Unit	CFM	942	942
	Fan Type		Axial-flow	Axial-flow
	Fan Diameter	inch	Φ15 3/4	Φ15 3/4
	Defrosting Method		/	Automatic Defrosting
	Climate Type		T1	T1
	Isolation		I	I
	Moisture Protection		IP24	IP24
	Permissible Excessive Operating Pressure for the Discharge Side	MPa	4.3	4.3
	Permissible Excessive Operating Pressure for the Suction Side	MPa	2.5	2.5
	Sound Pressure Level (H/M/L)	dB (A)	52/-/-	53/-/-
	Sound Power Level (H/M/L)	dB (A)	62/-/-	63/-/-
Dimension (WXHXD)	inch	30 5/9X21 1/4X12 3/5	30 5/9X21 1/4X12 3/5	
Dimension of Carton Box (LXWXH)	inch	33 2/5X14 1/6X22 5/6	33 2/5X14 1/6X22 5/6	
Dimension of Package (LXWXH)	inch	33 1/2X14 2/7X23 3/7	33 1/2X14 2/7X23 3/7	
Net Weight	lb	69.5	70.6	
Gross Weight	lb	75	76.1	
Refrigerant		R410A	R410A	
Refrigerant Charge	oz	0.85	0.85	
Connection Pipe	Length	ft	24.6	24.6
	Gas Additional Charge	oz/ft	0.2	0.2
	Outer Diameter Liquid Pipe	inch	Φ1/4	Φ1/4
	Outer Diameter Gas Pipe	inch	Φ3/8	Φ3/8
	Max Distance Height	ft	32.8	32.8
	Max Distance Length	ft	49.2	49.2
	Note:The connection pipe applies metric diameter.			

The above data is subject to change without notice. Please refer to the nameplate of the unit.

2.2 Operation Characteristic Curve

Cooling

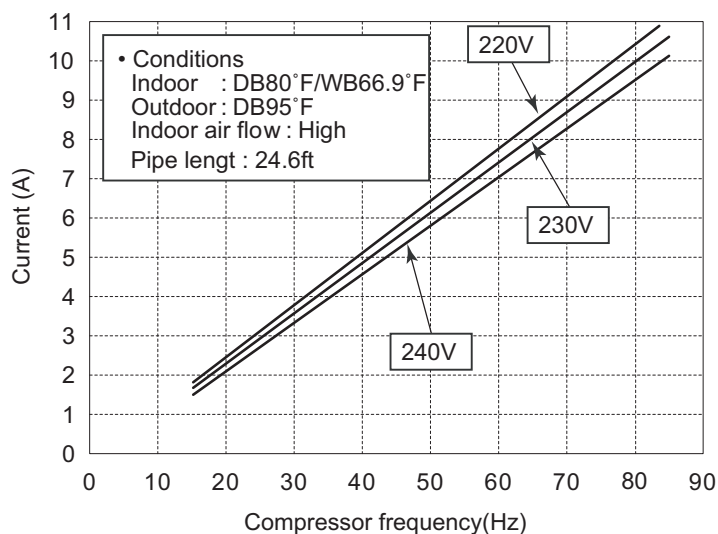

Heating

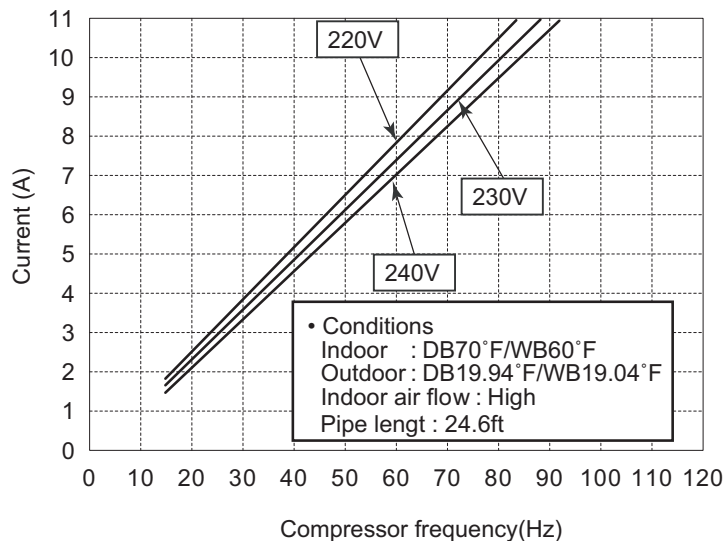

2.3 Capacity Variation Ratio According to Temperature

Cooling

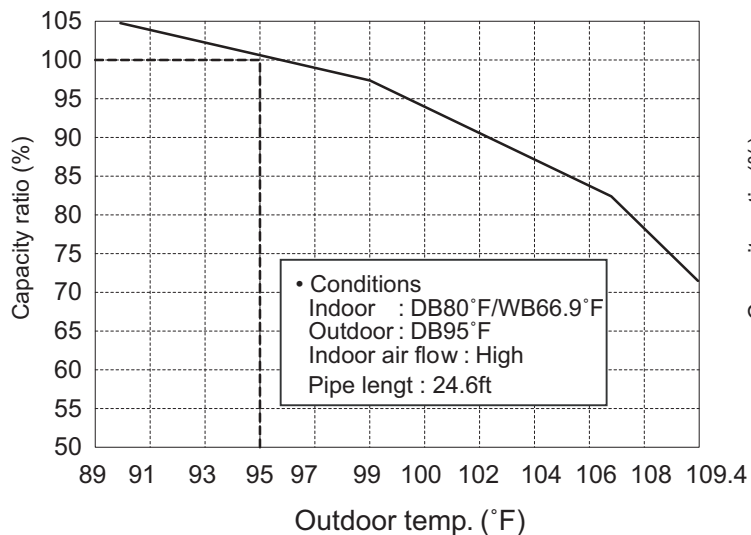

Heating

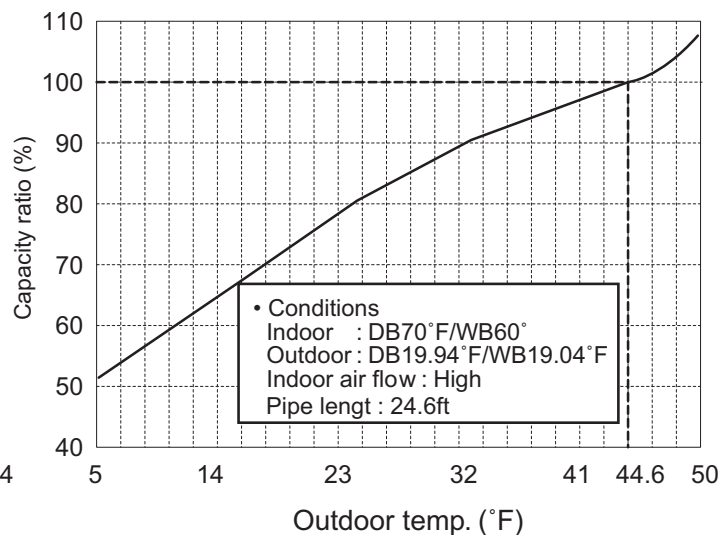

2.4 Cooling and Heating Data Sheet in Rated Frequency

Cooling:

Rated cooling condition(°F) (DB/WB)		Model	Pressure of gas pipe connecting indoor and outdoor unit	Inlet and outlet pipe temperature of heat exchanger		Fan speed of indoor unit	Fan speed of outdoor unit	Compressor revolution (rps)
Indoor	Outdoor			T1 (°F)	T2 (°F)			
80/66.9	95/-	09K	0.9~1.0	in:46.4~51.8 out:51.8~57.2	in:167~181.4 out:98.6~118.4	Super High	High	52
80/66.9	95/-	12K	0.9~1.0	in:46.4~51.8 out:51.8~57.2	in:167~181.4 out:98.6~118.4	Super High	High	72

Heating:

Rated heating condition(°F) (DB/WB)		Model	Pressure of gas pipe connecting indoor and outdoor unit	Inlet and outlet pipe temperature of heat exchanger		Fan speed of indoor unit	Fan speed of outdoor unit	Compressor revolution (rps)
Indoor	Outdoor			T1 (°F)	T2 (°F)			
70/60	19.94/19.04	09K	2.5~2.8	in:167~181.4 out:98.6~113	in:33.8~37.4 out:35.6~42.8	Super High	High	65
70/60	19.94/19.04	12K	2.5~2.8	in:167~181.4 out:98.6~113	in:33.8~37.4 out:35.6~42.8	Super High	High	77

Instruction:

T1: Inlet and outlet pipe temperature of evaporator

T2: Inlet and outlet pipe temperature of condenser

P: Pressure at the side of big valve

Connection pipe length: 24.6ft.

2.5 Noise Curve

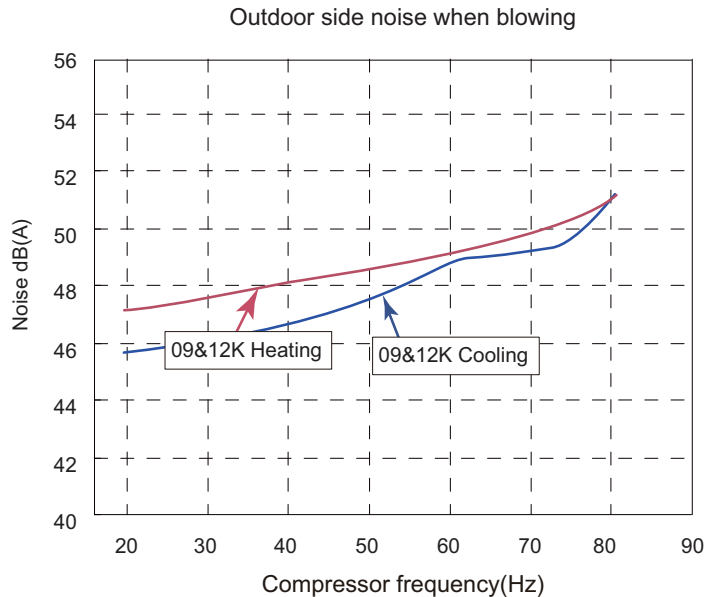
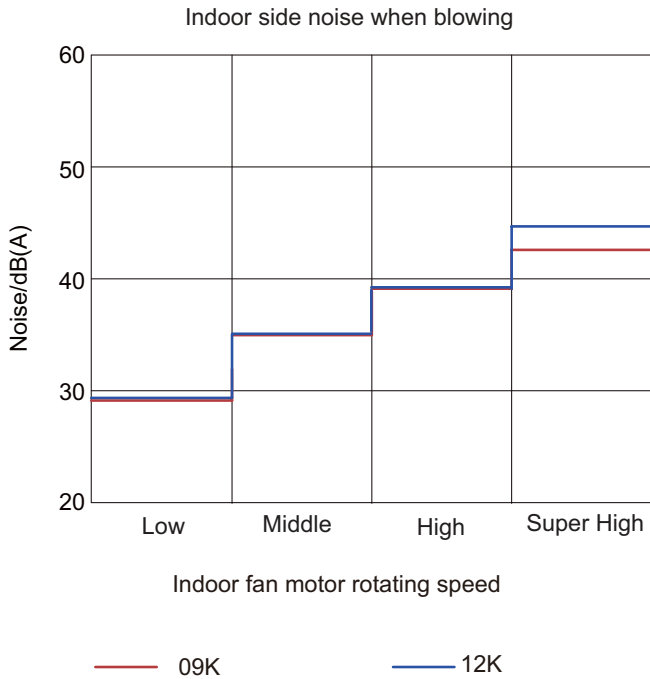

3. Outline Dimension Diagram

3.1 Indoor Unit

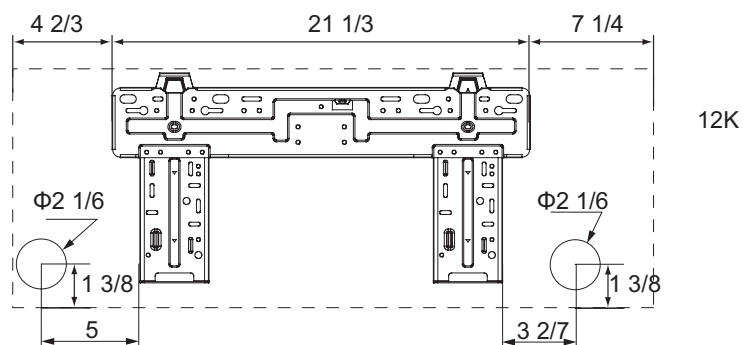
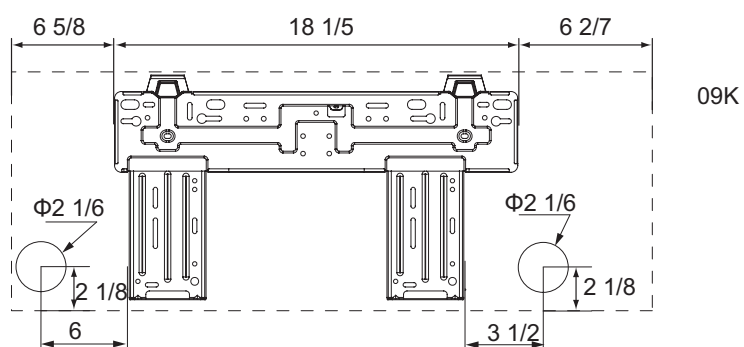
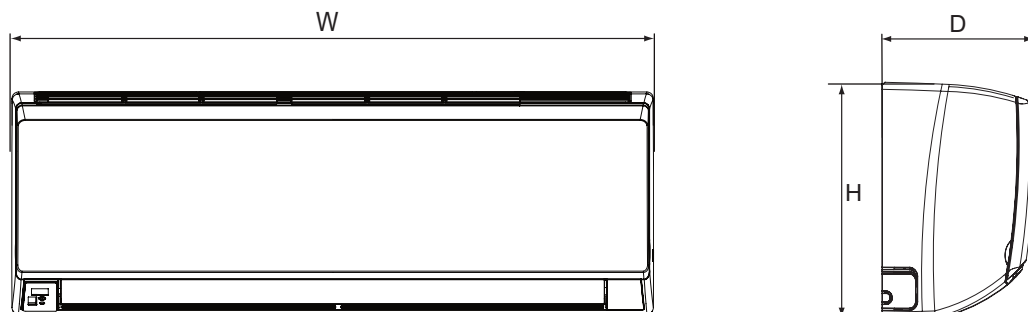

Unit:inch

MODEL	W	H	D
09K	31 1/9	10 5/6	7 7/8
12K	33 1/4	11 3/8	8 2/9

4. Refrigerant System Diagram

Cooling only models

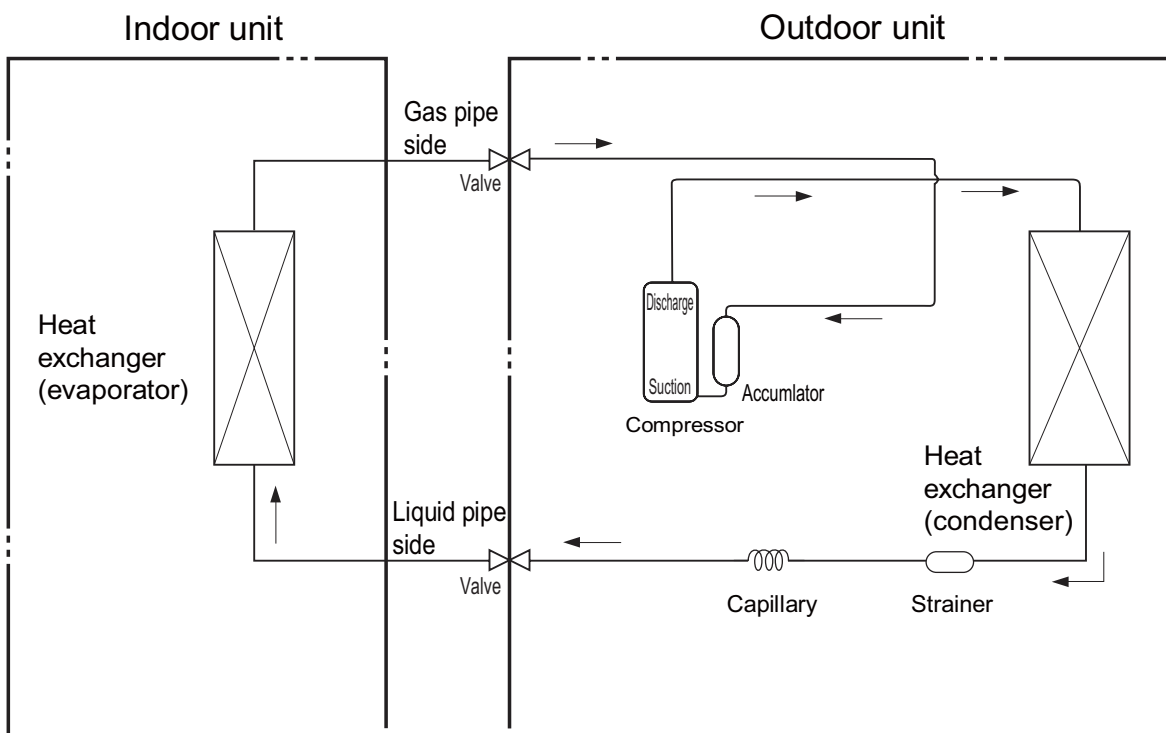

Cooling and heating models

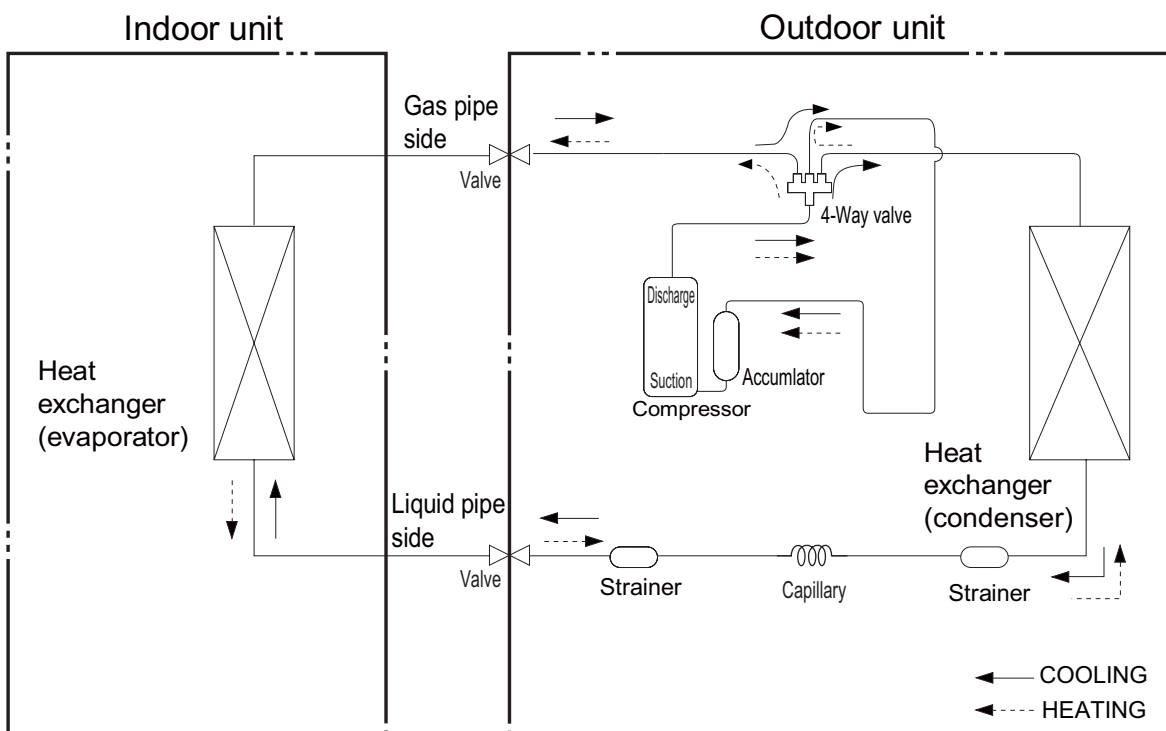

Connection pipe specification:
 Liquid pipe: 1/4"
 Gas pipe: 3/8"

5. Electrical Part

5.1 Wiring Diagram

• Instruction

Symbol	Symbol Color	Symbol	Symbol Color	Symbol	Name
WH	White	GN	Green	CAP	Jumper cap
YE	Yellow	BN	Brown	COMP	Compressor
RD	Red	BU	Blue	⊕	Grounding wire
YEGN	Yellow/Green	BK	Black	/	/
VT	Violet	OG	Orange	/	/

Note: Jumper cap is used to determine fan speed and the swing angle of horizontal lover for this model.

• Indoor Unit

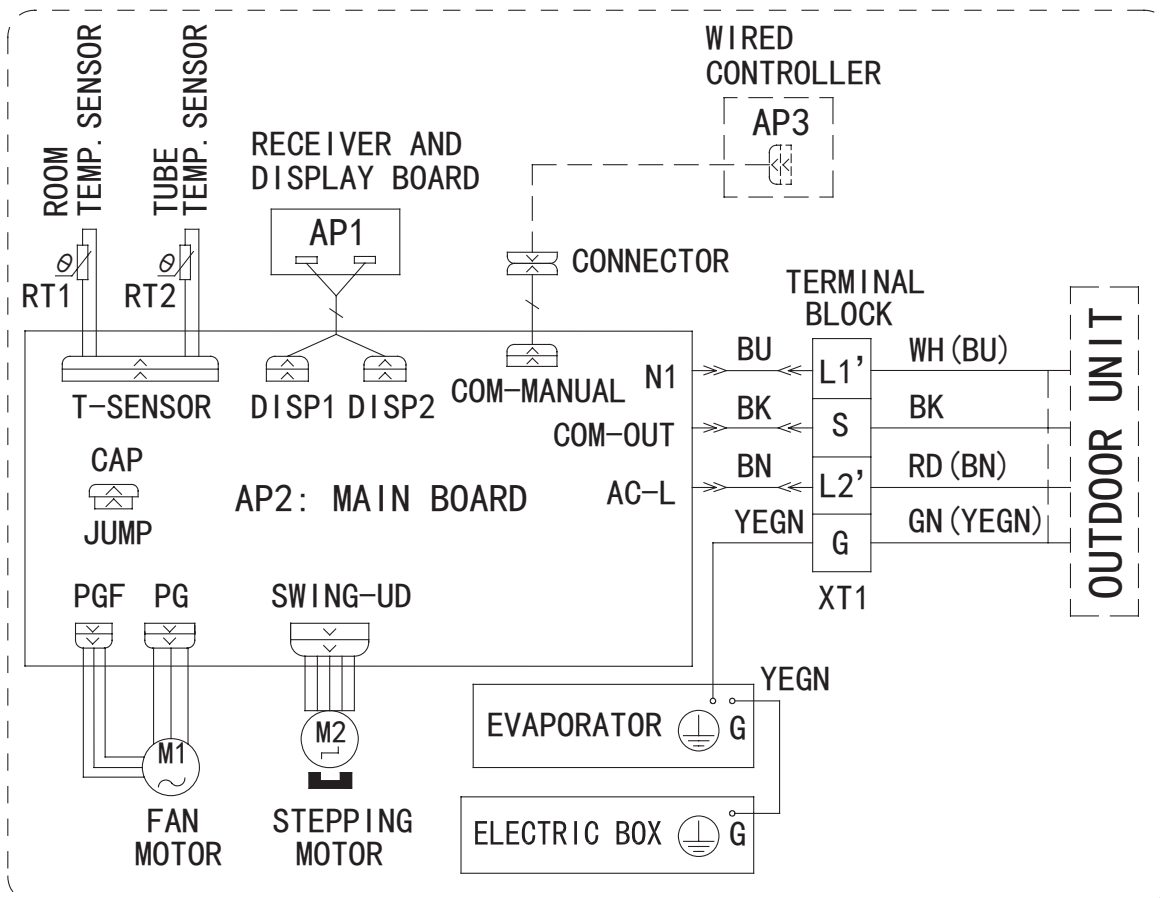

● Outdoor Unit

GWC09QB-D3DNA6E/O GWC12QC-D3DNA6E/O

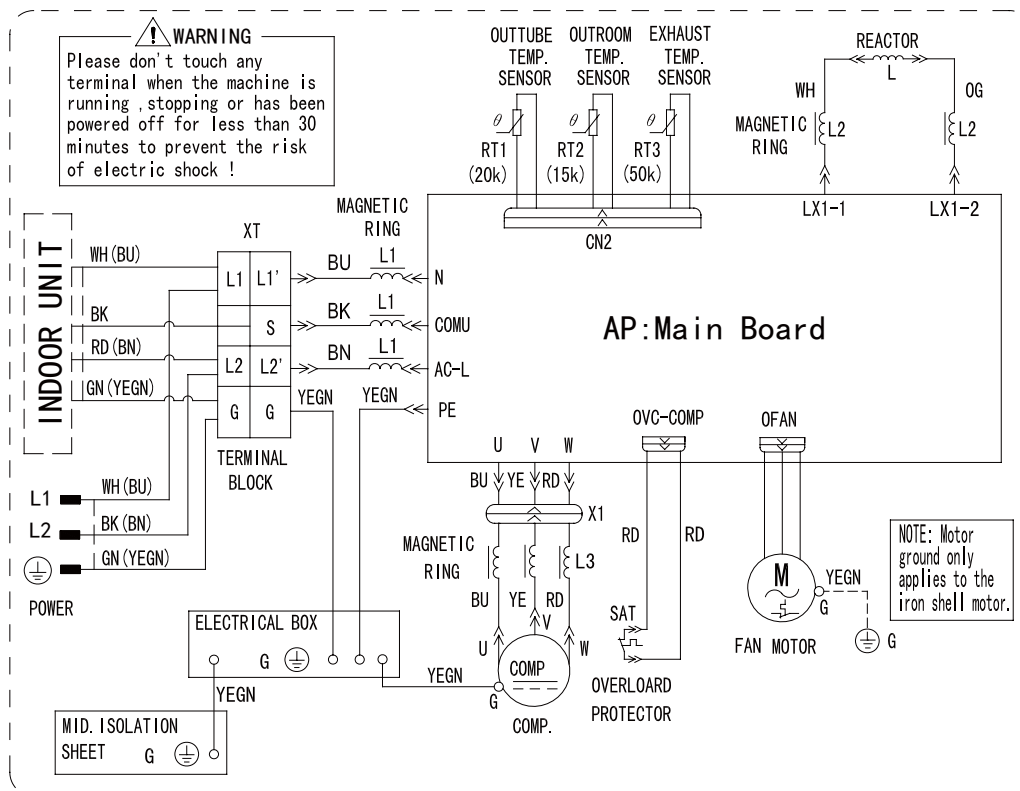

GWH09QB-D3DNA6E/O GWH12QC-D3DNA6E/O

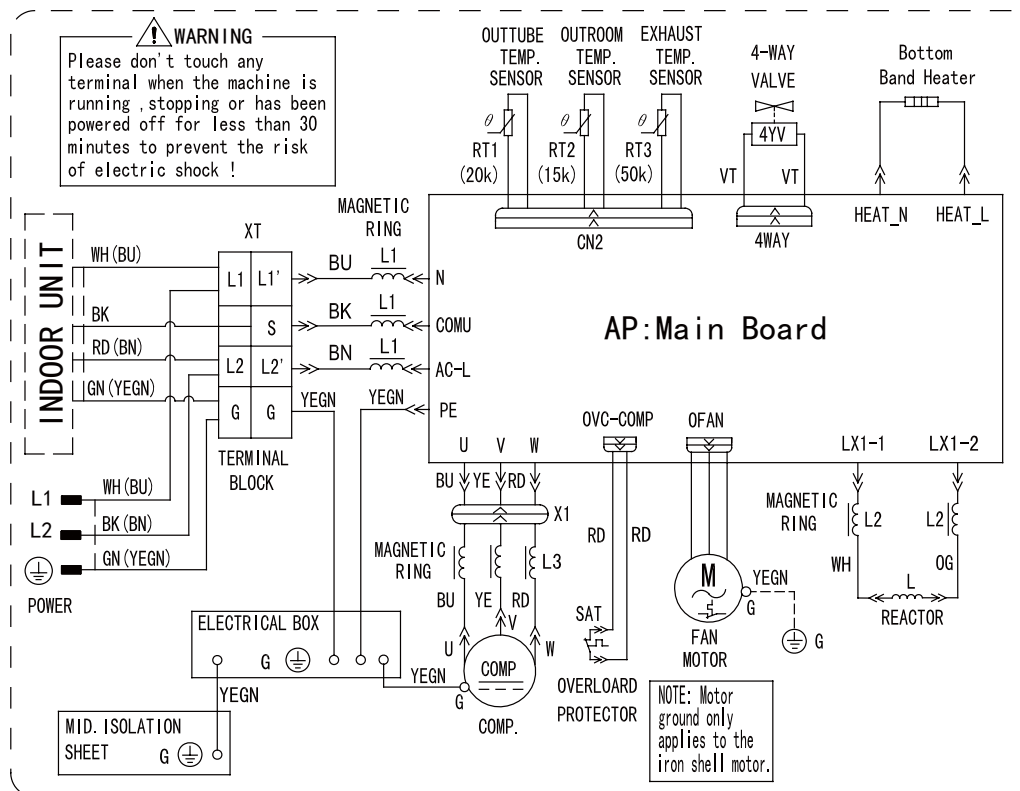

These circuit diagrams are subject to change without notice, please refer to the one supplied with the unit.

5.2 PCB Printed Diagram

Indoor Unit

• Top view

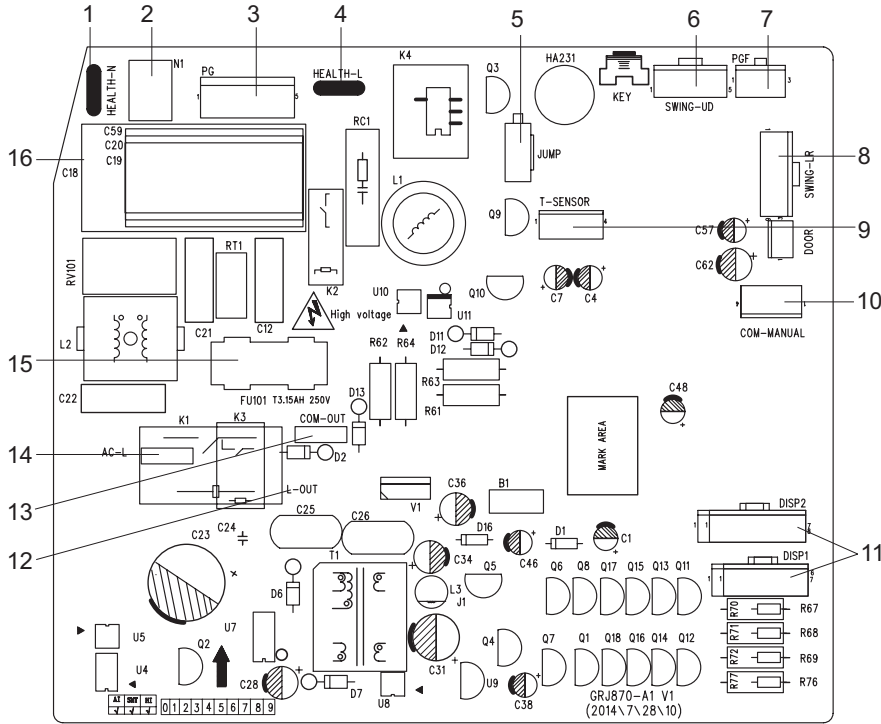

1	健康零线
2	零线
3	内风机电机
4	健康火线
5	跳线帽
6	上下扫风电机
7	内风机反馈接口
8	左右扫风电机
9	感温包接口
10	手操器接口
11	显示接口
12	压缩机控制口
13	通讯电路接口
14	火线
15	保险管
16	内风机电容

• Bottom view

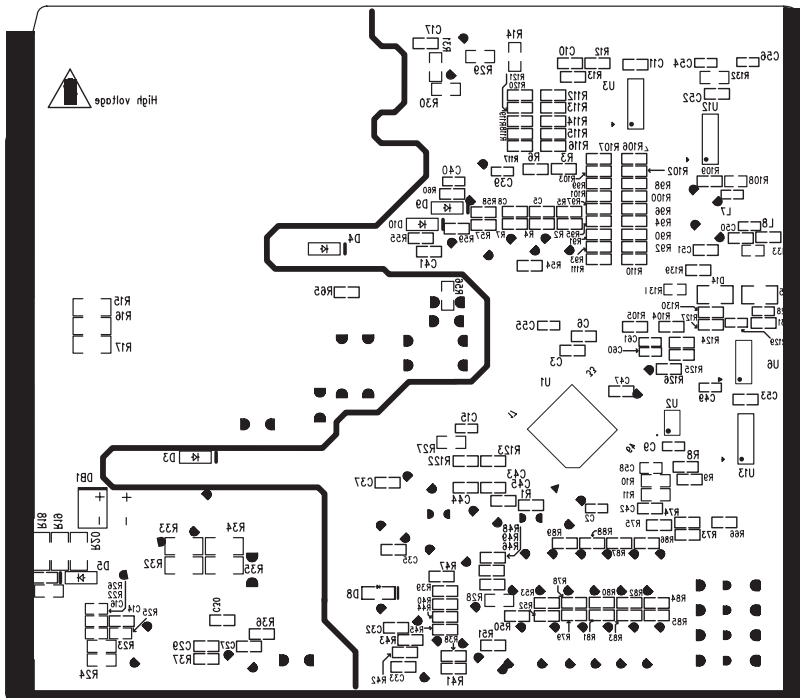

Outdoor Unit

• Top view

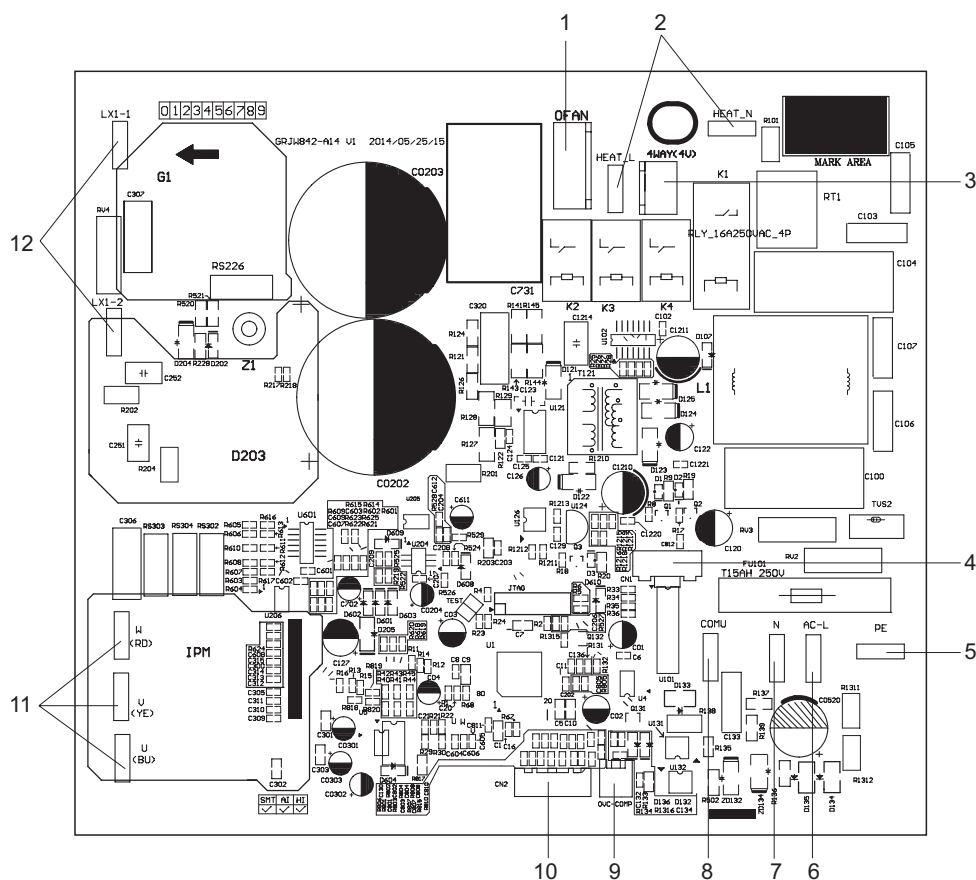

1	外风机接口
2	电加热带接口
3	四通阀接口
4	电子膨胀阀接口
5	地线接口
6	火线接口
7	零线接口
8	内外机通信线接口
9	压缩机过载接口
10	感温包线接口
11	压缩机线接口
12	PFC 线接口

• Bottom view

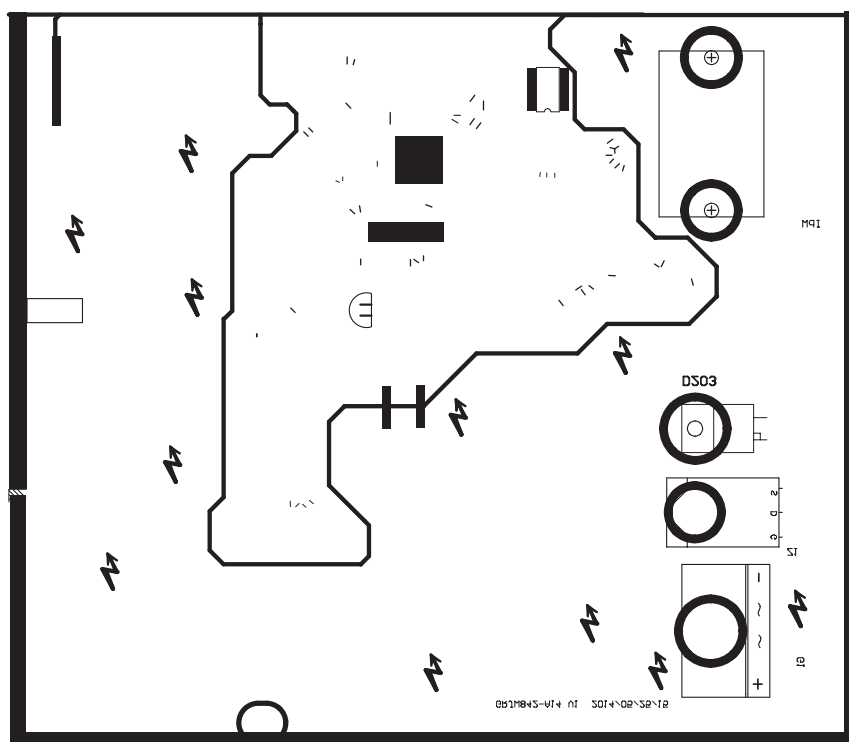

1. ON/OFF button

Press this button can turn on or turn off the air conditioner. After turning on the air conditioner, operation indicator "⏻" on indoor unit's display is ON (green indicator. The colour is different for different models), and indoor unit will give out a sound.

2. MODE button

Press this button to select your required operation mode.

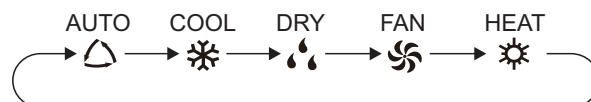

- When selecting auto mode, air conditioner will operate automatically according to ex-factory setting. Set temperature can't be adjusted and will not be displayed as well. Press "FAN" button can adjust fan speed. Press "SWING" button can adjust fan blowing angle.
- After selecting cool mode, air conditioner will operate under cool mode. Cool indicator "❄️" on indoor unit is ON. Press "▲" or "▼" button to adjust set temperature. Press "FAN" button to adjust fan speed. Press "SWING" button to adjust fan blowing angle.
- When selecting dry mode, the air conditioner operates at low speed under dry mode. Dry indicator "💧" on indoor unit is ON. Under dry mode, fan speed can't be adjusted. Press "SWING" button to adjust fan blowing angle.
- When selecting fan mode, the air conditioner will only blow fan, no cooling and no heating. All indicators are OFF. Press "FAN" button to adjust fan speed. Press "SWING" button to adjust fan blowing angle.
- When selecting heating mode, the air conditioner operates under heat mode. Heat indicator "☀️" on indoor unit is ON. Press "▲" or "▼" button to adjust set temperature. Press "FAN" button to adjust fan speed. Press "SWING" button to adjust fan blowing angle. (Cooling only unit won't receive heating mode signal. If setting heat mode with remote controller, press ON/OFF button can't start up the unit).

Note:

- For preventing cold air, after starting up heating mode, indoor unit will delay 1~5 minutes to blow air (actual delay time is depend on indoor ambient temperature).
- Set temperature range from remote controller: 16~30°C (60.8~86.0°F); Fan speed: auto, low speed, medium speed, high speed.

3. FAN button

Pressing this button can set fan speed circularly as: auto (AUTO), low(▲), medium(▲▲), high(▲▲▲).

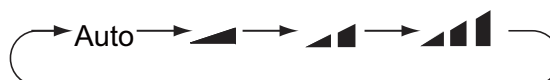

Caution:

- Under AUTO speed, air conditioner will select proper fan speed automatically according to ex-factory setting.
- Fan speed under dry mode is low speed.

4. SWING button

Press this button can select up&down swing angle. Fan blow angle can be selected circularly as below:

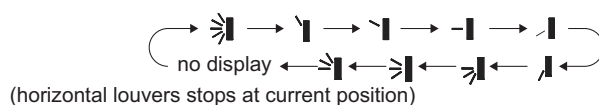

- When selecting "🌀", air conditioner is blowing fan automatically. Horizontal louver will automatically swing up & down at maximum angle.
- When selecting "┆", "┆┆", "┆┆┆", "┆┆┆┆", "┆┆┆┆┆", air conditioner is blowing fan at fixed position. Horizontal louver will stop at the fixed position.
- When selecting "↗", "↘", "↖", "↙", air conditioner is blowing fan at fixed angle. Horizontal louver will send air at the fixed angle.
- Hold "🌀" button above 2s to set your required swing angle. When reaching your required angle, release the button.

Note:

- "↗", "↘", "↖", "↙" may not be available. When air conditioner receives this signal, the air conditioner will blow fan automatically.

5. TURBO button

Under COOL or HEAT mode, press this button to turn to quick COOL or quick HEAT mode. "⚡" icon is displayed on remote controller. Press this button again to exit turbo function and "⚡" icon will disappear.

6. ▲/▼ button

- Press "▲" or "▼" button once increase or decrease set temperature 1°C (33.8°F). Holding "▲" or "▼" button, 2s later, set temperature on remote controller will change quickly. On releasing button after setting is finished, temperature indicator on indoor unit will change accordingly. (Temperature can't be adjusted under auto mode)
- When setting TIMER ON, TIMER OFF or CLOCK, press "▲" or "▲" button to adjust time. (Refer to CLOCK, TIMER ON, TIMER OFF buttons) When setting TIMER ON, TIMER OFF or CLOCK, press "▲" or "▲" button to adjust time. (Refer to CLOCK, TIMER ON, TIMER OFF buttons)

7. SLEEP button

Under COOL, HEAT or DRY mode, press this button to start up sleep function. "☾" icon is displayed on remote controller. Press this button again to cancel sleep function and "☾" icon will disappear.

8. TEMP button

By pressing this button, you can see indoor set temperature, indoor ambient temperature or outdoor ambient temperature on indoor unit's display. The setting on remote controller is selected circularly as below:

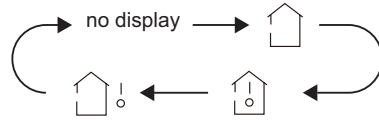

- When selecting "house icon" or no display with remote controller, temperature indicator on indoor unit displays set temperature.
- When selecting "house icon with thermometer" with remote controller, temperature indicator on indoor unit displays indoor ambient temperature.
- When selecting "house icon with thermometer and circle" with remote controller, temperature indicator on indoor unit displays outdoor ambient temperature.

Note:

- Outdoor temperature display is not available for some models. At that time, indoor unit receives "house icon with thermometer and circle" signal, while it displays indoor set temperature.
- It's defaulted to display set temperature when turning on the unit. There is no display in the remote controller.
- Only for the models whose indoor unit has dual-8 display.
- When selecting displaying of indoor or outdoor ambient temperature, indoor temperature indicator displays corresponding temperature and automatically turn to display set temperature after three or five seconds.

9. I FEEL button

Press this button to start I FEEL function and "I FEEL" icon will be displayed on the remote controller. After this function is set, the remote controller will send the detected ambient temperature to the controller and the unit will automatically adjust the indoor temperature according to the detected temperature. Press this button again to close I FEEL function and "I FEEL" icon will disappear.

- Please put the remote controller near user when this function is set. Do not put the remote controller near the object of high temperature or low temperature in order to avoid detecting inaccurate ambient temperature.

10. LIGHT button

Press this button to turn off display light on indoor unit. "light off" icon on remote controller disappears. Press this button again to turn on display light. "light on" icon is displayed.

11. CLOCK button

Press this button to set clock time. "clock" icon on remote controller will blink. Press "▲" or "▼" button within 5s to set clock time. Each pressing of "▲" or "▼" button, clock time will increase or decrease 1 minute. If hold "▲" or "▼" button, 2s later, time will change quickly. Release this button when reaching your required time. Press "CLOCK" button to confirm the time. "clock" icon stops blinking.

Note:

- Clock time adopts 24-hour mode.
- The interval between two operation can't exceeds 5s. Otherwise, remote controller will quit setting status. Operation for TIMER ON/TIMER OFF is the same.

12. TIMER ON / TIMER OFF button

• **TIMER ON button**

"TIMER ON" button can set the time for timer on. After pressing this button, "clock" icon disappears and the word "ON" on remote controller blinks. Press "▲" or "▼" button to adjust TIMER ON setting. After each pressing "▲" or "▼" button, TIMER ON setting will increase or decrease 1min. Hold "▲" or "▼" button, 2s later, the time will change quickly until reaching your required time. Press "TIMER ON" to confirm it. The word "ON" will stop blinking. "clock" icon resumes displaying. Cancel TIMER ON: Under the condition that TIMER ON is started up, press "TIMER ON" button to cancel it.

• **TIMER OFF button**

"TIMER OFF" button can set the time for timer off. After pressing this button, "clock" icon disappears and the word "OFF" on remote controller blinks. Press "▲" or "▼" button to adjust TIMER OFF setting. After each pressing "▲" or "▼" button, TIMER OFF setting will increase or decrease 1min. Hold "▲" or "▼" button, 2s later, the time will change quickly until reaching your required time. Press "TIMER OFF" word "OFF" will stop blinking. "clock" icon resumes displaying. Cancel TIMER OFF. Under the condition that TIMER OFF is started up, press "TIMER OFF" button to cancel it.

Note:

- Under on and off status, you can set TIMER OFF or TIMER ON simultaneously.
- Before setting TIMER ON or TIMER OFF, please adjust the clock time.
- After starting up TIMER ON or TIMER OFF, set the constant circulating valid. After that, air conditioner will be turned on or turned off according to setting time. ON/OFF button has no effect on setting. If you don't need this function, please use remote controller to cancel it.

Function introduction for combination buttons

1. Energy-saving function

Under cooling mode, press "TEMP" and "CLOCK" buttons simultaneously to start up or turn off energy-saving function. When energy-saving function is started up, "SE" will be shown on remote controller, and air conditioner will adjust the set temperature automatically according to ex-factory setting to reach to the best energy-saving effect. Press "TEMP" and "CLOCK" buttons simultaneously again to exit energy-saving function.

Note:

- Under energy-saving function, fan speed is defaulted at auto speed and it can't be adjusted.
- Under energy-saving function, set temperature can't be adjusted. Press "TURBO" button and the remote controller won't send signal.
- Sleep function and energy-saving function can't operate at the same time. If energy-saving function has been set under cooling mode, press sleep button will cancel energy-saving function. If sleep function has been set under cooling mode, start up the energy-saving function will cancel sleep function.

2. 8 °C heating function

Under heating mode, press "TEMP" and "CLOCK" buttons simultaneously to start up or turn off 8 °C heating function. When this function is started up, "8°C" and "8°C" will be shown on remote controller, and the air conditioner keep the heating status at 8 °C. Press "TEMP" and "CLOCK" buttons simultaneously again to exit 8 °C heating function.

Note:

- Under 8 °C heating function, fan speed is defaulted at auto speed and it can't be adjusted.
- Under 8 °C heating function, set temperature can't be adjusted. Press "TURBO" button and the remote controller won't send signal.
- Sleep function and 8 °C heating function can't operate at the same time. If 8 °C heating function has been set under cooling mode, press sleep button will cancel 8 °C heating function. If sleep function has been set under cooling mode, start up the 8 °C heating function will cancel sleep function.
- Under °F temperature display, the remote controller will display 46 °F heating.

3. Child lock function

Press "▲" and "▼" simultaneously to turn on or turn off child lock function. When child lock function is on, "🔒" icon is displayed on remote controller. If you operate the remote controller, the "🔒" icon will blink three times without sending signal to the unit.

4. Temperature display switchover function

Under OFF status, press "▼" and "MODE" buttons simultaneously to switch temperature display between °C and °F.

Operation guide

1. After putting through the power, press "ON/OFF" button on remote controller to turn on the air conditioner.
2. Press "MODE" button to select your required mode: AUTO, COOL, DRY, FAN, HEAT.
3. Press "▲" or "▼" button to set your required temperature. (Temperature can't be adjusted under auto mode).
4. Press "FAN" button to set your required fan speed: auto, low, medium and high speed.
5. Press "SWING" button to select fan blowing angle.

Replacement of batteries in remote controller

1. Press the back side of remote controller marked with "🔓", as shown in the fig, and then push out the cover of battery box along the arrow direction.
2. Replace two 7# (AAA 1.5V) dry batteries, and make sure the position of "+" polar and "-" polar are correct.
3. Reinstall the cover of battery box.

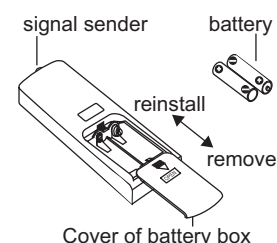

Note:

- During operation, point the remote control signal sender at the receiving window on indoor unit.
- The distance between signal sender and receiving window should be no more than 8m, and there should be no obstacles between them.
- Signal may be interfered easily in the room where there is fluorescent lamp or wireless telephone; remote controller should be close to indoor unit during operation.
- Replace new batteries of the same model when replacement is required.
- When you don't use remote controller for a long time, please take out the batteries.
- If the display on remote controller is fuzzy or there's no display, please replace batteries.

6.2 Brief Description of Modes and Functions

● Indoor Unit

1. Basic function of system

(1) Cooling mode

- (1) Under this mode, fan and swing operates at setting status. Temperature setting range is 60.8~86.0°F.
- (2) During malfunction of outdoor unit or the unit is stopped because of protection, indoor unit keeps original operation status.

(2) Drying mode

- (1) Under this mode, fan operates at low speed and swing operates at setting status. Temperature setting range is 60.8~86.0°F.
- (2) During malfunction of outdoor unit or the unit is stopped because of protection, indoor unit keeps original operation status.
- (3) Protection status is same as that under cooling mode.
- (4) Sleep function is not available for drying mode.

(3) Heating mode

- (1) Under this mode, Temperature setting range is 60.8~86.0°F.
- (2) Working condition and process for heating mode:

When turn on the unit under heating mode, indoor unit enters into cold air prevention status. When the unit is stopped or at OFF status, and indoor unit has been started up just now, the unit enters into residual heat-blowing status.

(4) Working method for AUTO mode:

1. Working condition and process for AUTO mode:
 - a. Under AUTO mode, standard heating Tpreset=68.0°F and standard cooling Tpreset=77.0°F. The unit will switch mode automatically according to ambient temperature.
2. Protection function
 - a. During cooling operation, protection function is same as that under cooling mode.
 - b. During heating operation, protection function is same as that under heating mode.
3. Display: Set temperature is the set value under each condition. Ambient temperature is (Tamb.-Tcompensation) for heat pump unit and Tamb. for cooling only unit.
4. If there's I feel function, Tcompensation is 0. Others are same as above.

(5) Fan mode

Under this mode, indoor fan operates at set fan speed. Compressor, outdoor fan, 4-way valve and electric heating tube stop operation. Indoor fan can select to operate at high, medium, low or auto fan speed. Temperature setting range is 60.8~86.0°F.

2. Other control

(1) Buzzer

Upon energization or availably operating the unit or remote controller, the buzzer will give out a beep.

(2) Auto button

If press this auto button when turning off the unit, the complete unit will operate at auto mode. Indoor fan operates at auto fan speed and swing function is turned on. Press this auto button at ON status to turn off the unit.

(3) Auto fan

Heating mode: During auto heating mode or normal heating mode, auto fan speed will adjust the fan speed automatically according to ambient temperature and set temperature.

(4) Sleep

After setting sleep function for a period of time, system will adjust set temperature automatically.

(5) Timer function:

General timer and clock timer functions are compatible by equipping remote controller with different functions.

(6) Memory function

memorize compensation temperature, off-peak energization value.

Memory content: mode, up&down swing, light, set temperature, set fan speed, general timer (clock timer can't be memorized).

After power recovery, the unit will be turned on automatically according to memory content.

(7) Health function

During operation of indoor fan, set health function by remote controller. Turn off the unit will also turn off health function.

Turn on the unit by pressing auto button, and the health is defaulted ON.

(8) I feel control mode

After controller received I feel control signal and ambient temperature sent by remote controller, controller will work according to the ambient temperature sent by remote controller.

(9) Compulsory defrosting function

(1) Start up compulsory defrosting function

Under ON status, set heating mode with remote controller and adjust the temperature to 60.8°F. Press "+, -, +, -, +,-" button successively within 5s and the complete unit will enter into compulsory defrosting status. Meanwhile, heating indicator on indoor unit will ON 10s and OFF 0.5s successively. (Note: If complete unit has malfunction or stops operation due to protection, compulsory defrosting function can be started up after malfunction or protection is resumed.

(2) Exit compulsory defrosting mode

After compulsory defrosting is started up, the complete unit will exit defrosting operation according to the actual defrosting result, and the complete unit will resume normal heating operation.

(10) Refrigerant recovery function:

(1) Enter refrigerant recycling function

Within 5min after energizing (unit ON or OFF status is ok), continuously press LIGHT button for 3 times within 3s to enter refrigerant recycling mode; Fo is displayed and refrigerant recycling function is started. At this moment, the maintenance people closes liquid valve. After 5min, stick the thimble of maintenance valve with a tool. If there is no refrigerant spraying out, close the gas valve immediately and then turn off the unit to remove the connection pipe.

(2) Exit refrigerant recycling function

After entering refrigerant recycling mode, when receive any remote control signal or enter refrigerant recycling mode for 25min, the unit will exit refrigerant recycling mode automatically. If the unit is in standby mode before refrigerant recycling, it will be still in standby mode after finishing refrigerant recycling; if the unit is in ON status before refrigerant recycling, it will still run in original operation mode.

(11) Ambient temperature display control mode

1. When user set the remote controller to display set temperature (corresponding remote control code: 01), current set temperature will be displayed.

2. Only when remote control signal is switched to indoor ambient temperature display status (corresponding remote control code: 10) from other display status (corresponding remote control code: 00, 01, 11), controller will display indoor ambient temperature for 3s and then turn back to display set temperature.

Under this mode, indoor fan operates at set fan speed. Compressor, outdoor fan, 4-way valve and electric heating tube stop operation. Indoor fan can select to operate at high, medium, low or auto fan speed. Temperature setting range is 60.8~86.0°F.

(12) Off-peak energization function:

Adjust compressor's minimum stop time. The original minimum stop time is 180s and then we change to:

The time interval between two start-ups of compressor can't be less than $180+T$ s ($0 \leq T \leq 15$). T is the variable of controller. That's to say the minimum stop time of compressor is 180s~195s. Read-in T into memory chip when refurbish the memory chip each time. After power recovery, compressor can only be started up after $180+T$ s at least.

(13) SE control mode

The unit operates at SE status.

(14) X-fan mode

When X-fan function is turned on, after turn off the unit, indoor fan will still operate at low speed for 2min and then the complete unit will be turned off. When x-fan function is turned off, after turn off the unit, the complete unit will be turned off directly.

(15) 8° heating function

Under heating mode, you can set 8° heating function by remote controller. The system will operate at 8° set temperature.

(16) Turbo fan control function

Set turbo function under cooling or heating mode to enter into turbo fan speed. Press fan speed button to cancel turbo wind.

No turbo function under auto, dry or fan mode.

Outdoor Units

1. Input Parameter Compensation and Calibration

(1) Check the ambient temperature compensation function Indoor ambient temperature compensation function.

- a. In cooling mode, the indoor ambient temperature participating in computing control = (T_{indoor ambient temperature} - Δ T_{cooling indoor ambient temperature compensation})
- b. In heating mode, the indoor ambient temperature participating in computing control = (T_{indoor ambient temperature} - Δ T_{heating indoor ambient temperature compensation})

(2) Check effective judgment controls of parameters

Effective judgment function of the outdoor exhaust temperature thermo-bulb When conditions a and b are satisfied, the outdoor exhaust temperature thermo-bulb is judged not to be connected into place, the mainboard of outer units will display failure of the outdoor exhaust temperature thermo-bulb (not connected into place), stop the machine for repairing, and resume the machine by remote controls of ON/OFF.

a. Judgment of exhaust detection temperature change:

After the compressor starts up and runs for 10 minutes, if the compressor frequency $f \geq 40\text{Hz}$, and the rising value T_{exhaust} ($T_{\text{exhaust (after start-up for 10 minutes)}} - T_{\text{exhaust (before start-up)}}$) $< 35.6^\circ\text{F}$, the outdoor exhaust temperature thermo-bulb can be judged not to be connected into place (judging once when the power is on the first time).

b. Comparative judgment of exhaust detection temperature and condenser detection temperature ($T_{\text{pipe temperature}} = T_{\text{outdoor pipe temperature in cooling mode}}$, $T_{\text{pipe temperature}} = T_{\text{indoor pipe temperature in heating mode}}$): After the compressor starts up and runs for 10 minutes, if the compressor frequency $f \geq 40\text{Hz}$, and $T_{\text{pipe temperature}} \geq (T_{\text{exhaust}} + 37.4)$, the outdoor exhaust temperature thermobulb can be judged not to be connected into place (judging once when power is on the first time).

2. Basic Functions

(1) Cooling Mode

1. Conditions and processes of cooling operation:

- (1) If the compressor is shut down, and $[T_{\text{setup}} - (T_{\text{indoor ambient temperature}} - \Delta T_{\text{cooling indoor ambient temperature compensation}})] \leq 32.9^\circ\text{F}$, start up the machine for cooling, the cooling operation will start;
- (2) During operations of cooling, if $32^\circ\text{F} \leq [T_{\text{setup}} - (T_{\text{indoor ambient temperature}} - \Delta T_{\text{cooling indoor ambient temperature compensation}})] < 35.6^\circ\text{F}$, the cooling operation will be still running;
- (3) During operations of cooling, if $35.6^\circ\text{F} \leq [T_{\text{setup}} - (T_{\text{indoor ambient temperature}} - \Delta T_{\text{cooling indoor ambient temperature compensation}})]$, the cooling operation will stop after reaching the temperature point.

2. Temperature setting range

- (1) If $T_{\text{outdoor ambient temperature}} \geq [T_{\text{low-temperature cooling temperature}}]$, the temperature can be set at: $60.8 \sim 86^\circ\text{F}$ (Cooling at room temperature);
- (2) If $T_{\text{outdoor ambient temperature}} < [T_{\text{low-temperature cooling temperature}}]$, the temperature can be set at: $77 \sim 86^\circ\text{F}$ (Cooling at low temperature), that is, the minimum setting temperature for outer units judgment is 77°F .

(2) Dehumidifying Mode

1. Conditions and processes of dehumidifying operations: Same as the cooling mode;
2. The temperature setting range is: $60.8 \sim 86^\circ\text{F}$;

(3) Air-supplying Mode

1. The compressor, outdoor fans and four-way valves are switched off;
2. The temperature setting range is: $60.8 \sim 86^\circ\text{F}$.

(4) Heating Mode

1. Conditions and processes of heating operations: ($T_{\text{indoor ambient temperature}}$ is the actual detection temperature of indoor environment thermo-bulb, $T_{\text{heating indoor ambient temperature compensation}}$ is the indoor ambient temperature compensation during heating operations)

- (1) If the compressor is shut down, and $[(T_{\text{indoor ambient temperature}} - \Delta T_{\text{heating indoor ambient temperature compensation}}) - T_{\text{setup}}] \leq 32.9^\circ\text{F}$, start the machine to enter into heating operations for heating;
 - (2) During operations of heating, if $32^\circ\text{F} \leq [(T_{\text{indoor ambient temperature}} - \Delta T_{\text{heating indoor ambient temperature compensation}}) - T_{\text{setup}}] < 35.6^\circ\text{F}$, the heating operation will be still running;
 - (3) During operations of heating, if $35.6^\circ\text{F} \leq [(T_{\text{indoor ambient temperature}} - \Delta T_{\text{heating indoor ambient temperature compensation}}) - T_{\text{setup}}]$, the heating operation will stop after reaching the temperature point.
2. The temperature setting range in this mode is: $60.8 \sim 86^\circ\text{F}$.

3. Special Functions

Defrosting Control

① Conditions for starting defrosting

After the time for defrosting is judged to be satisfied, if the temperature for defrosting is satisfied after detections for continuous 3minutes, the defrosting operation will start.

② Conditions of finishing defrosting

The defrosting operation can exit when any of the conditions below is satisfied:

③ $T_{\text{outdoor pipe temperature}} \geq (T_{\text{outdoor ambient temperature}} - [T_{\text{temperature 1 of finishing defrosting}}])$;

④ The continuous running time of defrosting reaches [tmax. defrosting time].

4. Control Logic

(1) Compressor Control

Start the compressor after starting cooling, heating, dehumidifying operations, and the outer fans start for 5s; When the machine is shutdown, in safety stops and when switching to air-supplying mode, the compressor will stop immediately. In all modes: once the compressor starts up, it will not be allowed to stop until having run for the [tmin. compressor running time] (Note: including cases of shutdown when the temperature point is reached; except the cases requiring stopping the compressor such as fault protection, remote shutdown, mode switching etc.); In all modes: once the compressor stops, it will be allowed to restart after 3-minute delay (Note: The indoor units have a function of power memory, the machine can be restarted after remote shutdown and powering up again without delay).

1. Cooling mode

Start the machine to enter into cooling operation for cooling, the compressor is switched on.

2. Dehumidifying mode

Same as the cooling mode.

3. Air-supplying mode

The compressor is switched off.

4. Heating mode

(1) Start the machine to enter into heating operation for heating, the compressor is switched on.

(2) Defrosting:

a. Defrosting starts: the compressor is shut down, and restarts it after 55-second delay.

b. Defrosting ends: the compressor stops, then starts it after 55-second delay.

(2) Outer Fans Control

Notes:

Only the outer fans run for at least 80s in each air flow speed can the air flow be switched;

After the outer fans run compulsively in high speed for 80s when the machine starts up, control the air flow according to the logic.

After remote shutdown, safety stops, and when the machine stops after reaching the temperature point, as well as after the compressor stops, extend 1 minute, the outer fans will stop (During the period in the 1 minute, the air flow of outer fans can be changed according to the outdoor ambient temperature changes); When running with force, the outdoor fans shall run in the highest air flow.

(3) 4-way valve control

1. The 4-way valve control under the modes of Cooling, dehumidification and supplying air: closing;

2. The status of 4-way valve control under the heating mode: getting power;

(1) 4-way valve power control under heating mode

a. Starts the machine under heating mode, the 4-way valve will get power immediately.

(2) 4-way valve power turn-off control under heating mode

a. When you should turn off the power or switch to other mode under heating mode, the power of 4-way valve will be cut after 2 minutes of the compressor stopped.

b. When all kinds of protection stops, the power of 4-way valve will be cut after delaying 4 minutes.

(3) Defrosting control under heating mode:

a. Defrosting begins: The power of 4-way valve will be cut after 50s of entering into the defrosting compressor.

b. Defrosting stops: The 4-way valve will get power after 50s of exiting the defrosting compressor.

(4) Evaporator frozen-preventing protection function

At the mode of Cooling, dehumidifying:

Evaporator frozen-preventing protection function is allowed to begin after 6 min of starting the compressor.

1. Starting estimation:

After the compressor stopped working for 180s, if $T_{\text{inner pipe}} > [T_{\text{frozen-preventing frequency-limited temperature}}$ (the temperature of hysteresis is 35.6°F), the machine is only allowed to start for operating, otherwise it should not be started, and should be stopped to treat according to the frozen-preventing protection: Clear the trouble under the mode of power turn-off / heating, and the protection times are not counted.

2. Frequency limited

If $[T_{\text{frozen-preventing normal speed frequency-reducing temperature}}] \leq [T_{\text{inner pipe}} T_{\text{frozen-preventing frequency-limited temperature}}]$, you should limit the frequency raising of compressor.

3. Reducing frequency at normal speed:

If $[T_{\text{frozen-preventing high speed frequency-reducing temperature}}] \leq [T_{\text{inner pipe}} T_{\text{frozen-preventing normal speed frequency-reducing temperature}}]$, you should adjust the compressor frequency by reducing 8Hz/90s till the lower limit;

4. Reducing frequency at high speed:

If $[T_{\text{frozen-preventing power turn-off temperature}}] \leq T_{\text{inner pipe}} [T_{\text{frozen-preventing high speed frequency-reducing temperature}}]$ you should adjust the compressor frequency by reducing 30Hz/90s till the lower limit;

5. Power turn-off:

If the $T_{\text{inner pipe}} < [T_{\text{frozen-preventing power turn-off temperature}}]$, then frozen-preventing protect to stop the machine; If $T_{\text{frozen-preventing frequency-limited temperature}} < T_{\text{inner pipe}}$, and the compressor has stopped working for 3 minutes, the whole machine should be allowed to operate.

6. If the frozen-preventing protection power turn-off continuously occurs for six times, it should not be resumed automatically, and you should press the ON/OFF button to resume if the fault keeps on. During the process of running, if the running time of compressor exceeds the t evaporator frozen-preventing protection times zero clearing time , the times of frozen-preventing power turn-off should be cleared to recount. The mode of stopping the machine or transferring to supply air will clear the trouble times immediately (if the trouble can not be resumed, mode transferring will not clear it).

(5) Overload protection function

Overload protection function at the mode of Cooling and dehumidifying

1. Starting estimation:

After the compressor stopped working for 180s, if $T_{\text{outer pipe}} < [T_{\text{Cooling overload frequency-limited temperature}}]$ (the temperature of hysteresis is 35.6°F), the machine is allowed to start, otherwise it should not be started, and should be stopped to treat according to the overload protection: Clear the trouble at the mode of power turn-off / heating, and the protection times are not counted.

2. Frequency limited

If $[T_{\text{Cooling overload frequency-limited temperature}}] \leq [T_{\text{outer pipe}} T_{\text{Cooling overload frequency reducing temperature at normal speed}}]$, you should limit the frequency raising of compressor.

3. Reducing frequency at normal speed and power turn-off:

If $[T_{\text{Cooling overload frequency reducing temperature at high speed}}] \leq T_{\text{outer pipe}} < [T_{\text{Cooling overload power turn-off temperature}}]$, you should adjust the compressor frequency by reducing 8Hz/90s till the lower limit; After it was running 90s at the lower limit, if $[T_{\text{Cooling overload frequency reducing temperature at normal speed}}] \leq T_{\text{outer pipe}}$, then Cooling overload protects machine stopping;

4. Reducing frequency at high speed and stop machine:

If $[T_{\text{Cooling overload frequency reducing temperature at high speed}}] \leq T_{\text{outer pipe}} [T_{\text{Cooling overload power turn-off temperature}}]$, you should adjust the compressor frequency by reducing 30Hz/90s till the lower limit; After it was running 90s at the lower limit, if $[T_{\text{Cooling overload frequency reducing temperature at normal speed}}] \leq [T_{\text{outer pipe}}]$, then Cooling overload protects machine stopping;

5. Power turn-off:

If the $[T_{\text{Cooling overload power turn-off temperature}}] \leq T_{\text{outer pipe}}$, then Cooling overload protects machine stopping; If $[T_{\text{outer pipe}}] < [T_{\text{Cooling overload frequency-limited temperature}}]$ and the compressor has been stopped working for 3 minutes, the machine should be allowed to operate.

6. If the Cooling overload protection power turn-off continuously occurs for six times, it should not be resumed automatically, and you should press the ON/OFF button to resume if the fault keeps on. During the process of running, if the running time of compressor exceeds the t overload protection times zero clearing time , the times of overload protection power turn-off should be cleared to recount. The mode of stopping the machine or transferring to supply air will clear the trouble times immediately (if the trouble can not be resumed, transferring mode will not clear it).

Overload protection function at the mode of heating

Starting estimation :

After the compressor stopped working for 180s, if $T_{\text{inner pipe}} T_{\text{heating overload frequency-limited temperature}}$ (the temperature of hysteresis is 35.6°F), the machine is allowed to start, otherwise it should not be started, and should be stopped to treat according to the overload protection:

Clear the trouble at the mode of power turn-off / heating, and the protection times are not counted.

1. Frequency limited

If $[T_{\text{heating overload frequency-limited temperature}}] \leq T_{\text{inner pipe}} < [T_{\text{heating overload frequency reducing temperature at normal speed}}]$, you should limit the frequency raising of compressor.

2. Reducing frequency at normal speed and stopping machine:

If $[T_{\text{heating overload frequency reducing temperature at normal speed}}] \leq T_{\text{inner pipe}} < [T_{\text{heating overload frequency reducing temperature at high speed}}]$, you should adjust the compressor frequency by reducing 8Hz/90s till the lower limit; After it was running 90s at the lower limit, if $T_{\text{heating overload frequency reducing temperature at normal speed}} \leq T_{\text{inner pipe}}$, then overload protects machine stopping;

3. Reducing frequency at high speed and power turn-off:

If $[T_{\text{heating overload frequency reducing temperature at high speed}}] \leq T_{\text{inner pipe}} < [T_{\text{heating overload power turn-off temperature}}]$, you should adjust the compressor frequency by reducing 30Hz/90s till the lower limit; After it was running 90s at the lower limit, if $T_{\text{heating overload frequency reducing temperature at normal speed}} \leq T_{\text{outer pipe}}$, then Cooling overload protects machine stopping;

4. Power turn-off:

If the $[T_{\text{heating overload power turn-off temperature}}] \leq T_{\text{inner pipe}}$, then overload protects machine stopping; If $T_{\text{inner pipe}} > T_{\text{heating overload frequency-limited temperature}}$ and the compressor has been stopped working for 3 minutes, the machine should be allowed to operate.

5. If the overload protection power turn-off continuously occurs for six times, it should not be resumed automatically, and you should press the ON/OFF button to resume if the fault keeps on. During the process of running, if the running time of compressor exceeds the $t_{\text{overload protection times zero clearing time}}$, the times of overload protection power turn-off should be cleared to recount. The mode of stopping the machine or transferring to supply air will clear the trouble times immediately (if the trouble can not be resumed, transferring mode will not clear it). Protective function for discharge temperature of compressor

1. Starting estimation:

After the compressor stopped working for 180s, if $T_{\text{Discharge}} < T_{\text{Discharge limited temperature}}$ (the temperature of hysteresis is 35.6°F), the machine is allowed to start, otherwise it should not be started, and should be stopped to treat according to the discharge temperature:

The machine should be stopped or transferred to supply air, the trouble should be cleared immediately, and the protection times are not counted.

2. Frequency limited

If $[T_{\text{Limited frequency temperature during discharging}}] \leq T_{\text{Discharge}} < [T_{\text{frequency reducing temperature at normal speed during discharging}}]$, you should limit the frequency raising of compressor.

3. Reducing frequency at normal speed and stopping machine:

If $[T_{\text{frequency reducing temperature at normal speed during discharging}}] \leq T_{\text{Discharge}} < [T_{\text{frequency reducing temperature at high speed during discharging}}]$, you should adjust the compressor frequency by reducing 8Hz/90s till the lower limit; After it was running 90s at the lower limit, if $[T_{\text{frequency reducing temperature at normal speed during discharging}}] \leq T_{\text{Discharge}}$, you should discharge to protect machine stopping;

4. Reducing frequency at high speed and power turn-off:

If $[T_{\text{frequency reducing temperature at high speed during discharging}}] \leq T_{\text{Discharge}} < [T_{\text{Stop temperature during discharging}}]$, you should adjust the compressor frequency by reducing 30Hz/90s till the lower limit; After it was running 90s at the lower limit, if $[T_{\text{frequency reducing temperature at normal speed during discharging}}] \leq T_{\text{Discharge}}$, you should discharge to protect machine stopping;

5. Power turn-off:

If the $[T_{\text{Power turn-off temperature during discharging}}] \leq T_{\text{Discharge}}$, you should discharge to protect machine stopping; If $[T_{\text{Discharge}}] < [T_{\text{Limited frequency temperature during discharging}}]$ and the compressor has been stopped for 3 minutes, the machine should be allowed to operate.

6. If the discharging temperature protection of compressor continuously occurs for six times, it should not be resumed automatically, and you should press the ON/OFF button to resume. During the process of running, if the running time of compressor exceeds the $t_{\text{Protection times clearing of discharge}}$, the discharge protection is cleared to recount. Stopped or transferred to supply air mode will clear the trouble times immediately (if the trouble can not be resumed, mode transferring also will not clear it).

7. Frequency limited

If $[I_{\text{Limited frequency when overcurrent}}] \leq I_{\text{AC Electric current}} < [I_{\text{frequency reducing when overcurrent}}]$, you should limit the frequency raising of compressor.

8. Reducing frequency:

If $[I_{\text{Frequency reducing when overcurrent}}] \leq [I_{\text{AC Electric current}} \text{ I Power turn-off when overcurrent}]$, you should reduce the compressor frequency till the lower limit or exit the frequency reducing condition;

9. Power turn-off:

If $[I_{\text{Power turn-off machine when overcurrent}}] \leq [I_{\text{AC Electric current}}]$, you should carry out the overcurrent stopping protection; If $I_{\text{AC Electric current}} < [I_{\text{Limited frequency when overcurrent}}]$ and the compressor has been stopped for 3 minutes, the machine should be allowed to operate.

10. If the overcurrent protection continuously occurs for six times, it should not be resumed automatically, and you should press the ON/OFF button to resume. During the process of running, if the running time of compressor exceeds the $[t_{\text{Protection times clearing of over current}}]$, the discharge protection is cleared to recount.

(6)Voltage sag protection

After start the compressor, if the time of DC link Voltage sag [$U_{\text{Sagging protection voltage}}$] is measured to be less than t Voltage sag protection time , the machine should be stop at once, hand on the voltage sag trouble, reboot automatically after 30 minutes.

(7)Communication fault

When you have not received any correct signal from the inner machine in three minutes, the machine will stop for communication fault. When you have not received any correct signal from driver IC (aim to the controller for the separating of main control IC and driver IC), and the machine will stop for communication fault. If the communication is resumed, the machine will be allowed to operate.

(8)Module protection

Testing the module protective signal immediately after started, once the module protective signal is measured, stop the machine with module protection immediately. If the module protection is resumed, the machine will be allowed to operate. If the module protection continuously occurs for three times, it should not be resumed automatically, and you should press the ON/OFF button to resume. If the running time of compressor exceeds the [$t_{\text{Protection times clearing of module}}$] , the module protection is cleared to recount.

(9)Module overheating protection

1. Starting estimation:

After the compressor stopped working for 180s, if $T_{\text{Module}} < [T_{\text{Module frequency limited temperature}}]$ (the temperature of hysteresis is 35.6°F), the machine is allowed to start, otherwise it should not be started, and should be stopped to treat according to the module overheating protection: The machine should be stopped or transferred to supply air, the trouble should be cleared immediately, and the protection times are not counted.

2. Frequency limited

If [$T_{\text{Limited frequency temperature of module}}$] $\leq T_{\text{Module}} < [T_{\text{frequency reducing temperature at normal speed of module}}]$, you should limit the frequency raising of compressor.

3. Reducing frequency at normal speed and power turn-off:

If [$T_{\text{frequency reducing temperature at normal speed of module}}$] $\leq T_{\text{Module}} < [T_{\text{frequency reducing temperature at high speed of module}}]$, you should adjust the compressor frequency by reducing 8Hz/90s till the lower limit; After it was running 90s at the lower limit, if [$T_{\text{frequency reducing temperature at normal speed of module}}$] $\leq T_{\text{Module}}$, you should stop the machine for module overheating protection;

4. Reducing frequency at high speed and power turn-off:

If [$T_{\text{frequency reducing temperature at high speed of module}}$] $\leq T_{\text{Module}} < [T_{\text{Power turn-off temperature of module}}]$ you should adjust the compressor frequency by reducing 30Hz/90s till the lower limit; After it was running 90s at the lower limit, if [$T_{\text{frequency reducing temperature at normal speed of module}}$] $\leq T_{\text{Module}}$, you should stop the machine for module overheating protection;

5. Power turn-off:

If the [$T_{\text{Power turn-off temperature of module}}$] $\leq T_{\text{Module}}$, you should stop the machine for module overheating protection; If $T_{\text{Module}} < [T_{\text{Limited frequency temperature of module}}]$ and the compressor has been stopped for 3 minutes, the machine should be allowed to operate.

6. If protection continuously occurs for six times, it should not be resumed automatically, and you should press the ON/OFF button to resume. During the process of running, if the running time of compressor exceeds the [$t_{\text{Protection times clearing of module}}$] , the discharge protection is cleared to recount. Stopped or transferred to supply air mode will clear the trouble times immediately (if the trouble can not be resumed, mode transferring also will not clear it).

(10)Compressor overloads protection

If you measure the compressor overload switch action in 3s, the compressor should be stopped for overloading. The machine should be allowed to operate after overload protection was measured to resume. If the overloading protection continuously occurs for three times, it should not be resumed automatically, and you should press the ON/OFF button to resume. The protection times of compressor is allowed to clear after the compressor run [$t_{\text{Protection times clearing of compressor overloading}}$] 30 minutes.

(11)Phase current overcurrent protection of compressor

During the running process of compressor, you could measure the phase current of the compressor, and control it according to the following steps:

1. Frequency limited

If [$I_{\text{Limited frequency phase current}}$] $\leq I_{\text{Phase current}} < [I_{\text{frequency reducing phase current}}]$, you should limit the frequency raising of compressor.

2. Reducing Frequency

If [$I_{\text{Frequency Reducing Phase Current}}$] $\leq I_{\text{Phase Current}} < [I_{\text{Power Turn-Off Phase Current}}]$, the compressor shall continue to reduce frequency till the lowest frequency limit or out of the condition of reducing frequency;

3. Power turn-off

If [$I_{\text{Phase Current}}$] $\geq [I_{\text{Power Turn-Off Phase Current}}]$, the compressor phase current shall stop working for overcurrent protection; if [$I_{\text{Phase Current}}$] $\leq [I_{\text{Frequency Reducing Phase Current}}]$, and the compressor have stopped working for 3 min, the machine shall be allowed to operate;

4. If the overcurrent protection of compressor phase current continuously occurs for six times, it should not be resumed automatically, and you should press the ON/OFF button to resume. During the process of running, if the running time of compressor exceeds the [$t_{\text{Clearing Time of Compressor Phase Current Times}}$] , the overcurrent protection is cleared to recount.

(12) Starting-up Failure Protection for Compressor

Stop the compressor after its starting-up fails, restart it after 20s if the fault doesn't shows, and if they are all failing for the successive start 3 times, it shall be reported as Starting-up Failure, and then restart up it after 3 min. When it still not be able to operate through carry out the above process for 5 times, it is available if press ON/OFF. And the compressor should be cleared the times after it run 2 min.

(13) Out-of-Step Protection for Compressor

The out-of-step protection signal should be detected immediately after starting-up compressor, and once find the out-of-step protection signal, the out-of-step protection shall be stopped; if it can run for lasting power turn-off 3 min, the machine shall be allowed to operate. If it still can't run automatically when the out-of-step protection for compressor happens to stop working for 6 times in succession, it needs to press ON/OFF to operate. And if the running time is more than 10 min, the power turn-off times for out-of-step protection shall be cleared and recounted.

(14) Voltage Abnormity Protection for DC Bus

To detect voltage abnormity protection for dc bus after completing the pre-charge:

1.Over-High Voltage Protection for DC Bus:

If it found the DCbus voltage $U_{DC} > [UDC_{Jiekuangchun\ Protection}]$, turn off PFC and stop the compressor at once, and it shall show the DC over-high voltage failure; it should clear out the failure when the voltage dropped to $U_{DC} < [UDC_{Jiekuangchun\ Recovery}]$ and the compressor stopped for 3 min.

2.Over-Low Voltage Protection for DC Bus:

If it found the DC bus voltage $U_{DC} < [U_{DC\ Wantuochun\ Protection}]$, turn off PFC and stop the compressor at once, and it shall show the DC over-low voltage; and it should clear out the failure when the voltage raised to $U_{DC} > [U_{DC\ Wantuochun\ Recovery}]$ and the compressor stopped for 3 min.

3.To detect voltage abnormity protect for DC bus when getting electricity:

If it found the DC bus voltage $U_{DC} > [U_{DC\ Over-High\ Voltage}]$, turn off the relay at once, and shows voltage abnormity failure for DC Bus. And the failure can't recover except to break off and get the electricity.

(15)Abnormity Protection for Four-way Valve

Under the model of heating operation in good condition: the compressor is detected $[T_{Inner\ Tube} < (T_{Inner\ Ring} - T_{Abnormity\ Temperature\ Difference\ For\ Four-Way\ Valve\ Reversion})]$, during the running, it should be regarded as four-way valve reversion abnormity. And then it can run if stop the reversion abnormity protection for four-way valve 3 min; and if it still can't run when the reversion abnormity protection for four-way valve happens to stop working for 3 times in succession, it is available if presses ON/OFF.

Attention: the protection shall be shielded during the testing mode and defrosting process, and it shall be cleared out the failure and its times immediately when turning off or delivering wind / cooling / dehumidifying mode conversed (the inverted mode don't clear out the failure when it can't recover to operate).

(16) PFC Protection

1. After start up the PFC, it should detect the protection signal of PFC immediately; under the condition of PFC protection, it should turn off the PFC and compressor at one time;
2. It shows the failure is cleared out if PFC Protection stopped working 3 min and recovers to run automatically;
3. If it still can't run when it occurs PFC protection for 3 times in succession, it is available if presses ON/OFF; and clear the PFC Protection times when start up PFC for 10min.

(17) Failure Detection for Sensor

1. Outdoor Ambient Sensor: detect the failure of sensor at all times.
2. Outdoor Tube Sensor: You should not detect the failure of outdoor tube sensor within 10 minutes heating operation compressor except the defrosting, and you could detect it at other time.
3. Outdoor Exhaust Sensor:
 - (a) The compressor only detect the sensor failure after it start up 3 min in normal mode;
 - (b) It should detect the exhaust sensor failure immediately in the testing mode.
4. Module Temperature Sensor:
 - (a) Short-Circuit Detection: the compressor should be detected immediately when the module temperature sensor occurs short-circuits;
 - (b) Open-Circuit Detection: the compressor should be detected on open-circuit when it runs 3min (it needn't 30s avoiding the module over-heated).
 - (c) Detect the sensor failure at all times in the testing mode.
5. Disposal for Sensor Protection
 - (1) When the short-circuit of sensor is detected within 30s, It is regarded as the temperature of sensor over-high (or infinitely high), and now according to the over-high sensor, the machine should carry out the corresponding protection to stop working, and show the corresponding temperature shutdown protection and sensor failure at the same time (for example: the compressor stops immediately when the outdoor tube sensor short-circuit, and the machine shall show the overload protection and outdoor tube sensor failure).
 - (2) When the open-circuit of sensor is detected within 30s, The protection shall be stopped and it shall show the corresponding sensor failure.

6. Electric Heating Function of Chassis

- (1) When Toutdoor amb. $\leq 32^{\circ}\text{F}$, the electric heating of chassis will operate;
- (2) When Toutdoor amb. $> 35.6^{\circ}\text{F}$, the electric heating of chassis will stop operation;
- (3) When $32^{\circ}\text{F} < \text{Toutdoor amb.} \leq 35.6^{\circ}\text{F}$, the electric heating of chassis will keep original status.

7. Electric Heating Function of Compressor

- (1) When Toutdoor amb. $\leq 23^{\circ}\text{F}$, compressor stops operation, while the electric heating of compressor starts operation;
- (2) When Toutdoor amb. $> 28.4^{\circ}\text{F}$, the electric heating of compressor stops operation;
- (3) When $23^{\circ}\text{F} < \text{Toutdoor amb.} \leq 28.4^{\circ}\text{F}$, the electric heating of compressor will keep original status.

Part II : Installation and Maintenance

7. Notes for Installation and Maintenance

Safety Precautions: Important!

Please read the safety precautions carefully before installation and maintenance.

The following contents are very important for installation and maintenance.

Please follow the instructions below.

- The installation or maintenance must accord with the instructions.
- Comply with all national electrical codes and local electrical codes.
- Pay attention to the warnings and cautions in this manual.
- All installation and maintenance shall be performed by distributor or qualified person.
- All electric work must be performed by a licensed technician according to local regulations and the instructions given in this manual.
- Be caution during installation and maintenance. Prohibit incorrect operation to prevent electric shock, casualty and other accidents.



Warnings

Electrical Safety Precautions:

1. Cut off the power supply of air conditioner before checking and maintenance.
2. The air condition must apply specialized circuit and prohibit share the same circuit with other appliances.
3. The air conditioner should be installed in suitable location and ensure the power plug is touchable.
4. Make sure each wiring terminal is connected firmly during installation and maintenance.
5. Have the unit adequately grounded. The grounding wire can't be used for other purposes.
6. Must apply protective accessories such as protective boards, cable-cross loop and wire clip.
7. The live wire, neutral wire and grounding wire of power supply must be corresponding to the live wire, neutral wire and grounding wire of the air conditioner.
8. The power cord and power connection wires can't be pressed by hard objects.
9. If power cord or connection wire is broken, it must be replaced by a qualified person.

10. If the power cord or connection wire is not long enough, please get the specialized power cord or connection wire from the manufacture or distributor. Prohibit prolong the wire by yourself.

11. For the air conditioner without plug, an air switch must be installed in the circuit. The air switch should be all-pole parting and the contact parting distance should be more than 1/8 inch.

12. Make sure all wires and pipes are connected properly and the valves are opened before energizing.

13. Check if there is electric leakage on the unit body. If yes, please eliminate the electric leakage.

14. Replace the fuse with a new one of the same specification if it is burnt down; don't replace it with a cooper wire or conducting wire.

15. If the unit is to be installed in a humid place, the circuit breaker must be installed.

Installation Safety Precautions:

1. Select the installation location according to the requirement of this manual.(See the requirements in installation part)
2. Handle unit transportation with care; the unit should not be carried by only one person if it is more than 44.09lb.
3. When installing the indoor unit and outdoor unit, a sufficient fixing bolt must be installed; make sure the installation support is firm.
4. Ware safety belt if the height of working is above 78 3/4 inch.
5. Use equipped components or appointed components during installation.
6. Make sure no foreign objects are left in the unit after finishing installation.

Refrigerant Safety Precautions:

1. Avoid contact between refrigerant and fire as it generates poisonous gas; Prohibit prolong the connection pipe by welding.
2. Apply specified refrigerant only. Never have it mixed with any other refrigerant. Never have air remain in the refrigerant line as it may lead to rupture or other hazards.
3. Make sure no refrigerant gas is leaking out when installation is completed.
4. If there is refrigerant leakage, please take sufficient measure to minimize the density of refrigerant.
5. Never touch the refrigerant piping or compressor without wearing glove to avoid scald or frostbite.

Improper installation may lead to fire hazard, explosion, electric shock or injury.

Main Tools for Installation and Maintenance

<p>1. Level meter, measuring tape</p> 	<p>2. Screw driver</p> 	<p>3. Impact drill, drill head, electric drill</p> 
<p>4. Electroprobe</p> 	<p>5. Universal meter</p> 	<p>6. Torque wrench, open-end wrench, inner hexagon spanner</p> 
<p>7. Electronic leakage detector</p> 	<p>8. Vacuum pump</p> 	<p>9. Pressure meter</p> 
<p>10. Pipe pliers, pipe cutter</p> 	<p>11. Pipe expander, pipe bender</p> 	<p>12. Soldering appliance, refrigerant container</p> 

8. Installation

8.1 Installation Dimension Diagram

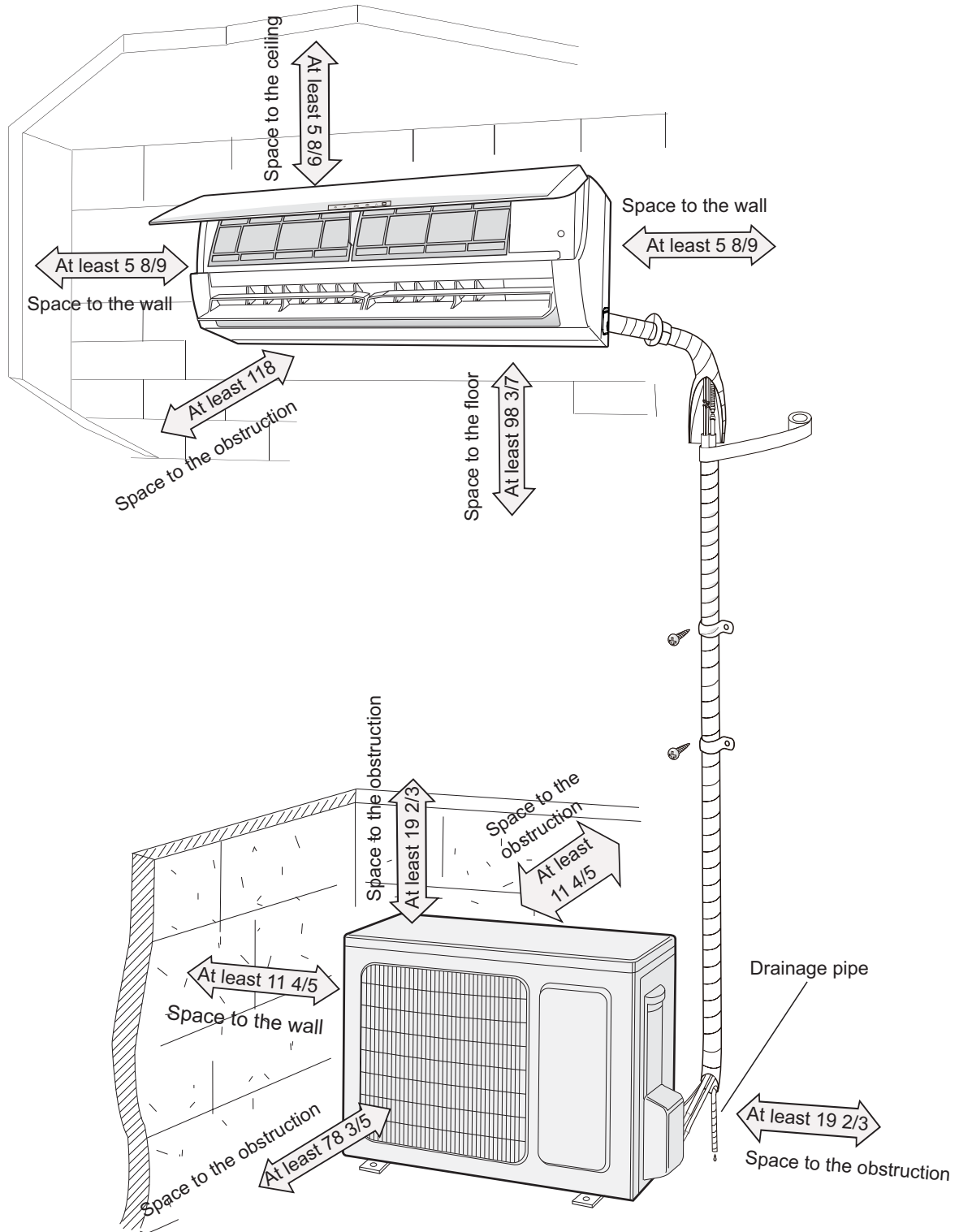

Unit:inch

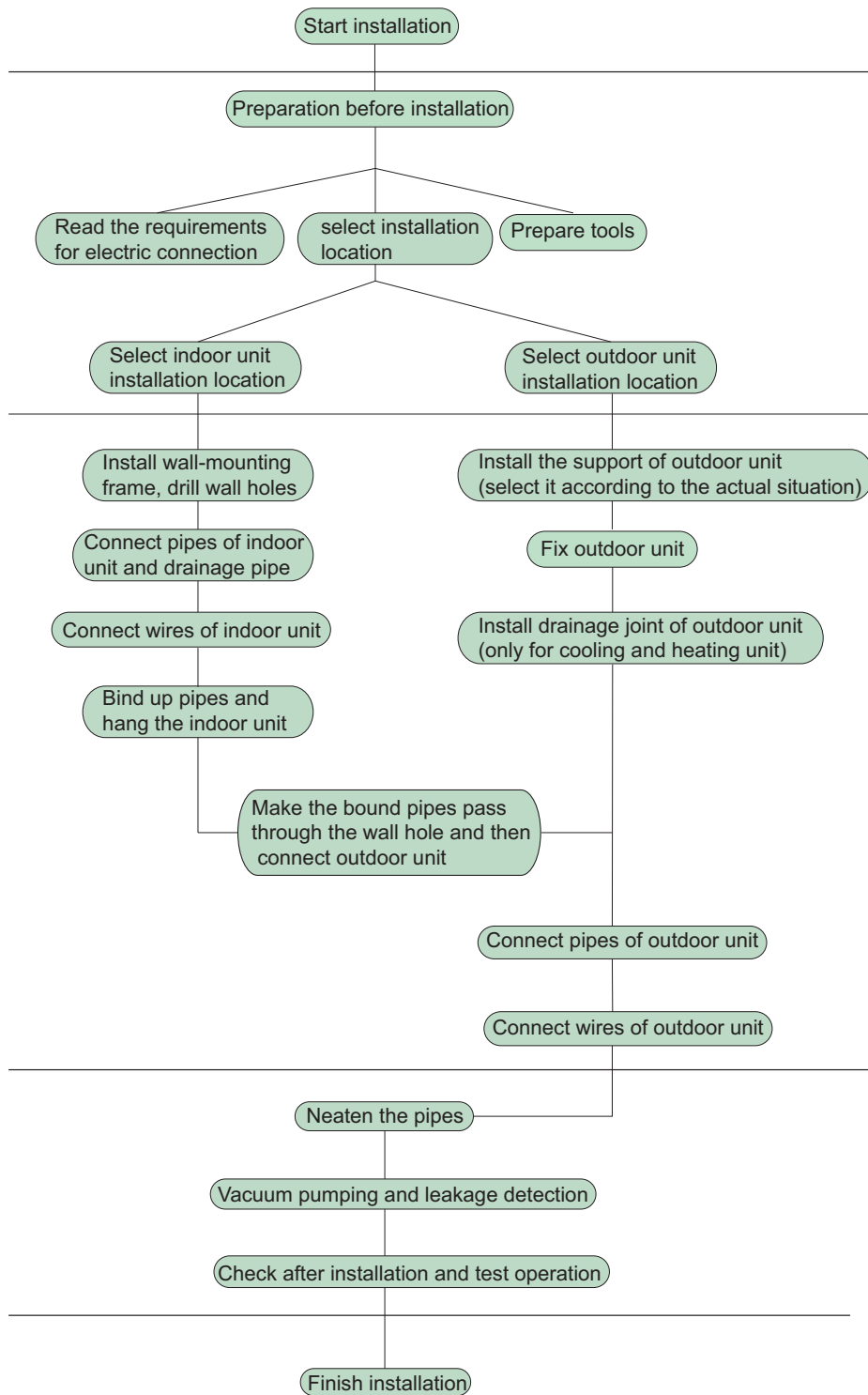

Note: this flow is only for reference; please find the more detailed installation steps in this section.

8.2 Installation Parts-checking

No.	Name	No.	Name
1	Indoor unit	8	Sealing gum
2	Outdoor unit	9	Wrapping tape
3	Connection pipe	10	Support of outdoor unit
4	Drainage pipe	11	Fixing screw
5	Wall-mounting frame	12	Drainage plug(cooling and heating unit)
6	Connecting cable(power cord)	13	Owner's manual, remote controller
7	Wall pipe		

⚠ Note:

- 1.Please contact the local agent for installation.
- 2.Don't use unqualified power cord.

8.3 Selection of Installation Location

1. Basic Requirement:

Installing the unit in the following places may cause malfunction. If it is unavoidable, please consult the local dealer:

- (1) The place with strong heat sources, vapors, flammable or explosive gas, or volatile objects spread in the air.
- (2) The place with high-frequency devices (such as welding machine, medical equipment).
- (3) The place near coast area.
- (4) The place with oil or fumes in the air.
- (5) The place with sulfureted gas.
- (6) Other places with special circumstances.

2. Indoor Unit:

- (1) There should be no obstruction near air inlet and air outlet.
- (2) Select a location where the condensation water can be dispersed easily and won't affect other people.
- (3) Select a location which is convenient to connect the outdoor unit and near the power socket.
- (4) Select a location which is out of reach for children.
- (5) The location should be able to withstand the weight of indoor unit and won't increase noise and vibration.
- (6) The appliance must be installed 98 3/7 inch above floor.
- (7) Don't install the indoor unit right above the electric appliance.
- (8) The appliance shall not be installed in the laundry.

3. Outdoor Unit:

- (1) Select a location where the noise and outflow air emitted by the outdoor unit will not affect neighborhood.
- (2) The location should be well ventilated and dry, in which the outdoor unit won't be exposed directly to sunlight or strong wind.
- (3) The location should be able to withstand the weight of outdoor unit.
- (4) Make sure that the installation follows the requirement of installation dimension diagram.
- (5) Select a location which is out of reach for children and far away from animals or plants.If it is unavoidable, please add fence for safety purpose.

8.4 Electric Connection Requirement

1. Safety Precaution

- (1) Must follow the electric safety regulations when installing the unit.
- (2) According to the local safety regulations, use qualified power supply circuit and air switch.
- (3) Make sure the power supply matches with the requirement of air conditioner. Unstable power supply or incorrect wiring may result in electric shock,fire hazard or malfunction. Please install proper power supply cables before using the air conditioner.

Air-conditioner	Air switch capacity
09/12K	15A

- (4) Properly connect the live wire, neutral wire and grounding wire of power socket.
- (5) Be sure to cut off the power supply before proceeding any work related to electricity and safety.
- (6) Do not put through the power before finishing installation.
- (7) For appliances with type Y attachment,the instructions shall contain the substance of thefollowing.If the supply cord is damaged,it must be replaced by the manufacturer,its service agent or similarly qualified persons in order to avoid a hazard.
- (8) The temperature of refrigerant circuit will be high, please keep the interconnection cable away from the copper tube.

2. Grounding Requirement:

- (1) The air conditioner is first class electric appliance. It must be properly grounding with specialized grounding device by a professional. Please make sure it is always grounded effectively, otherwise it may cause electric shock.
- (2) The yellow-green wire in air conditioner is grounding wire, which can't be used for other purposes.
- (3) The grounding resistance should comply with national electric safety regulations.
- (4) The appliance must be positioned so that the plug is accessible.
- (5) An all-pole disconnection switch having a contact separation of at least 1/8 inch in all poles should be connected in fixed wiring.
- (6) Including an air switch with suitable capacity, please note the following table. Air switch should be included magnet buckle and heating buckle function, it can protect the circuit-short and overload. (Caution: please do not use the fuse only for protect the circuit)

8.5 Installation of Indoor Unit

1. Choosing Installation location

Recommend the installation location to the client and then confirm it with the client.

2. Install Wall-mounting Frame

- (1) Hang the wall-mounting frame on the wall; adjust it in horizontal position with the level meter and then point out the screw fixing holes on the wall.
- (2) Drill the screw fixing holes on the wall with impact drill (the specification of drill head should be the same as the plastic expansion particle) and then fill the plastic expansion particles

in the holes.

(3) Fix the wall-mounting frame on the wall with tapping screws (ST4.2X25TA) and then check if the frame is firmly installed by pulling the frame. If the plastic expansion particle is loose, please drill another fixing hole nearby.

3. Install Wall-mounting Frame

(1) Choose the position of piping hole according to the direction of outlet pipe. The position of piping hole should be a little lower than the wall-mounted frame.(As show in Fig.1)

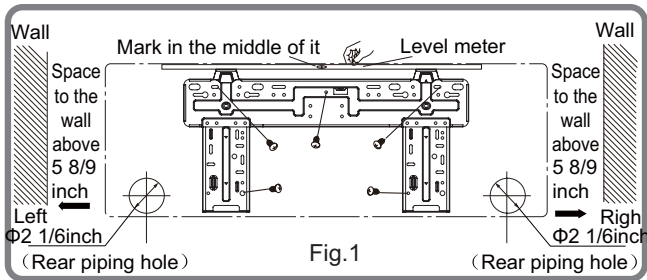

(2) Open a piping hole with the diameter of 2 1/6inch on the selected outlet pipe position. In order to drain smoothly, slant the piping hole on the wall slightly downward to the outdoor side with the gradient of 5-10°. (As show in Fig.2)

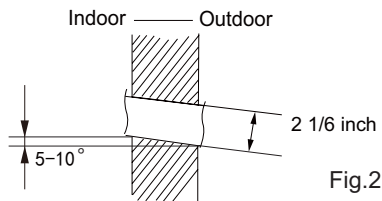

⚠ Note:

- (1) Pay attention to dust prevention and take relevant safety measures when opening the hole.
- (2) The plastic expansion particles are not provided and should be bought locally.

4. Outlet Pipe

- (1) The pipe can be led out in the direction of right, rear right, left or rear left. (As show in Fig.3)
- (2) When selecting leading out the pipe from left or right, please cut off the corresponding hole on the bottom case. (As show in Fig.4)

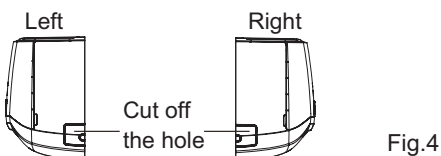
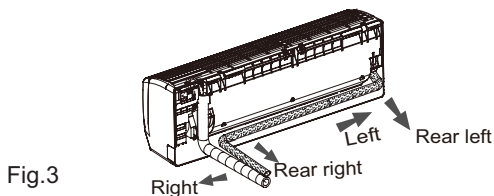

5. Connect the Pipe of Indoor Unit

- (1) Aim the pipe joint at the corresponding bellmouth. (As show in Fig.5)
- (2) Pretightening the union nut with hand.
- (3) Adjust the torque force by referring to the following sheet. Place the open-end wrench on the pipe joint and place the torque wrench on the union nut. Tighten the union nut with torque wrench. (As show in Fig.6)
- (4) Wrap the indoor pipe and joint of connection pipe with insulating pipe, and then wrap it with tape. (As show in Fig.7)

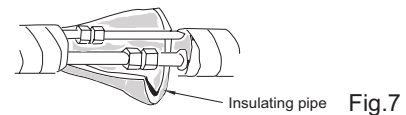
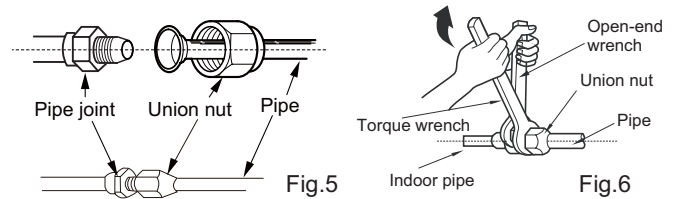

Refer to the following table for wrench moment of force :

Hex nut diameter(inch)	Tightening torque(ft-lbf)
Φ1/4	11.10~14.75
Φ3/8	22.12~29.50
Φ1/2	33.19~40.56
Φ5/8	44.24~47.94
Φ3/4	51.32~55.31

6. Install Drain Hose

- (1) Connect the drain hose to the outlet pipe of indoor unit. (As show in Fig.8)
- (2) Bind the joint with tape. (As show in Fig.9)

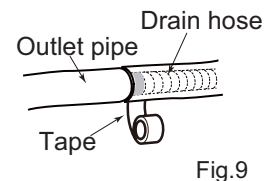
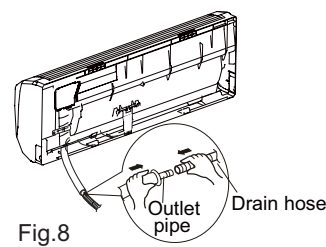

⚠ Note:

- (1) Add insulating pipe in the indoor drain hose in order to prevent condensation.
- (2) The plastic expansion particles are not provided. (As show in Fig.10)

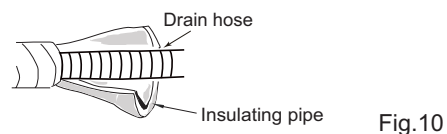

7. Connect Wire of Indoor Unit

(1) Open the panel, remove the screw on the wiring cover and then take down the cover.(As show in Fig.11)

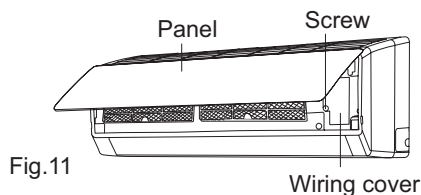

Fig.11

(2) Fix the wire crossing board on connection wire sleeve at the bottom case; let the connection wire sleeve go through the wire crossing hole at the back of indoor unit, and then pull it out from the front.(As show in Fig.12)

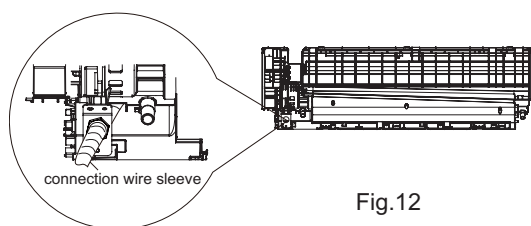

Fig.12

(3) Remove the wire clip; connect the power connection wire to the wiring terminal; tighten the screw and then fix the power connection wire with wire clip.(As show in Fig.13)

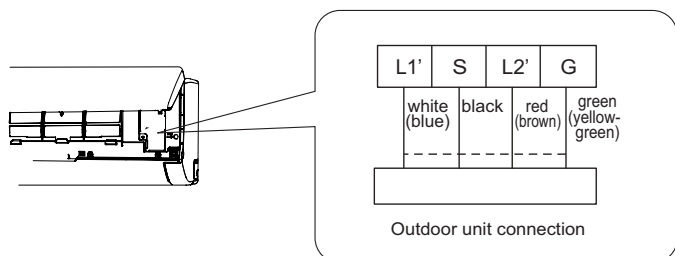

Fig.13

(4) Put wiring cover back and then tighten the screw.
 (5) Close the panel.

⚠ Note:

- (1) All wires of indoor unit and outdoor unit should be connected by a professional.
- (2) If the length of power connection wire is insufficient, please contact the supplier for a new one. Avoid extending the wire by yourself.
- (3) For the air conditioner with plug, the plug should be reachable after finishing installation.
- (4) For the air conditioner without plug, an air switch must be installed in the line. The air switch should be all-pole parting and the contact parting distance should be more than 3mm.

8. Bind up Pipe

- (1) Bind up the connection pipe, power cord and drain hose with the band.(As show in Fig.14)
- (2) Reserve a certain length of drain hose and power cord for installation when binding to a certain degree, separate the indoor power and then separate the drain hose.(As show in Fig.15)
- (3) Bind them evenly.
- (4) The liquid pipe and gas pipe should be bound separately at the end.

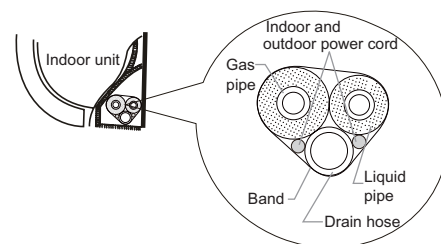

Fig.14

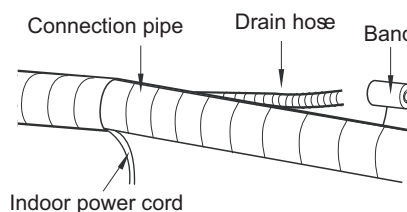

Fig.15

⚠ Note:

- (1) The power cord and control wire can't be crossed or winding.
- (2) The drain hose should be bound at the bottom.

9. Hang the Indoor Unit

- (1) Put the bound pipes in the wall pipe and then make them pass through the wall hole.
- (2) Hang the indoor unit on the wall-mounting frame.
- (3) Stuff the gap between pipes and wall hole with sealing gum.
- (4) Fix the wall pipe.(As show in Fig.16)
- (5) Check if the indoor unit is installed firmly and closed to the wall.(As show in Fig.17)

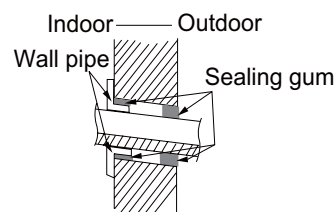

Fig.16

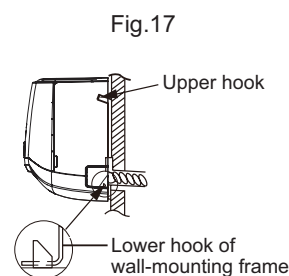

Fig.17

⚠ Note:

Do not bend the drain hose too excessively in order to prevent blocking.

8.6 Installation of Outdoor Unit

1. Fix the Support of Outdoor Unit(Select it according to the actual installation situation)

- (1) Select installation location according to the house structure.
- (2) Fix the support of outdoor unit on the selected location with expansion screws.

⚠ Note:

- (1) Take sufficient protective measures when installing the outdoor unit.
- (2) Make sure the support can withstand at least four times the unit weight.
- (3) The outdoor unit should be installed at least 1 1/6 inch above the floor in order to install drain joint.(As show in Fig.18)
- (4) For the unit with cooling capacity of 2300W~5000W, 6 expansion screws are needed; for the unit with cooling capacity of 6000W~8000W, 8 expansion screws are needed; for the unit with cooling capacity of 10000W~16000W, 10 expansion screws are needed.

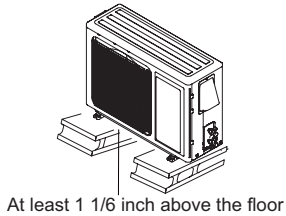

Fig.18

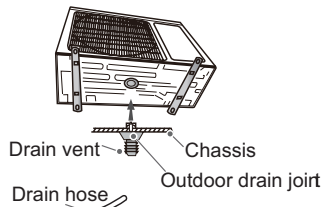

Fig.19

2. Install Drain Joint(only for cooling and heating unit)

- (1) Connect the outdoor drain joint into the hole on the chassis.
 - (2) Connect the drain hose into the drain vent.
- (As show in Fig.19)

3. Fix Outdoor Unit

- (1) Place the outdoor unit on the support.
 - (2) Fix the foot holes of outdoor unit with bolts.
- (As show in Fig.20)

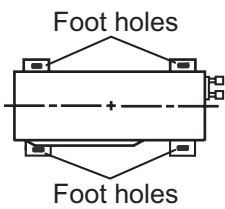

Fig.20

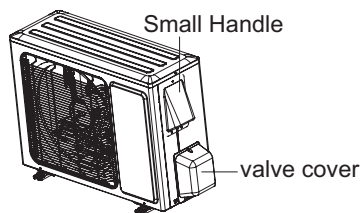

Fig.21

4. Connect Indoor and Outdoor Pipes

- (1) Remove the screw on the small handle and valve cover of outdoor unit and then remove the handle and valve cover.(As show in Fig.21)
- (2) Remove the screw cap of valve and aim the pipe joint at the bellmouth of pipe.(As show in Fig.22)

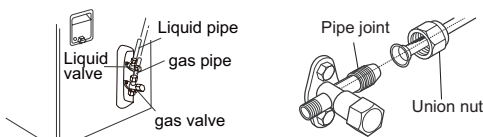

Fig.22

- (3) Pretightening the union nut with hand.
- (4) Tighten the union nut with torque wrench .

Refer to the following table for wrench moment of force :

Hex nut diameter(inch)	Tightening torque(ft·lbf)
Φ1/4	11.10~4.75
Φ3/8	22.12~29.50
Φ1/2	33.19~40.56
Φ5/8	44.24~47.94
Φ3/4	51.32~55.31

5. Connect Outdoor Electric Wire

- (1) Let the connection wire sleeve go through the two holes of baffle; tighten the connection joint of sleeve and baffle; remove the wire clip; connect the power connection wire and power cord to the wiring terminal according to the color; fix them with screws.(As show in Fig.23)

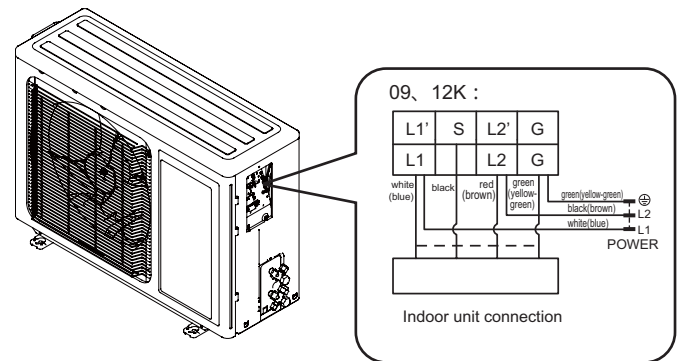

Fig.23

- (2) Fix the power connection wire and power cord with wire clip.
- (3) Fix the stopper on handle with screw.

⚠ Note:

- (1) After tightening the screw, pull the power cord slightly to check if it is firm.
- (2) Never cut the power connection wire to prolong or shorten the distance.

6. Neaten the Pipes

- (1) The pipes should be placed along the wall, bent reasonably and hidden possibly. Min. semidiameter of bending the pipe is 10cm.
- (2) If the outdoor unit is higher than the wall hole, you must set a U-shaped curve in the pipe before pipe goes into the room, in order to prevent rain from getting into the room.(As show in Fig.24)

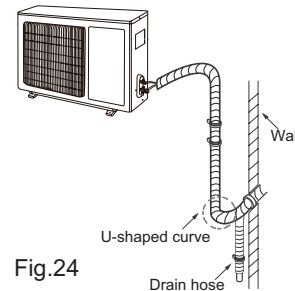

Fig.24

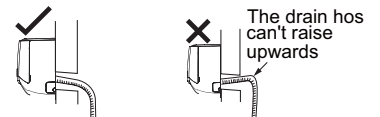
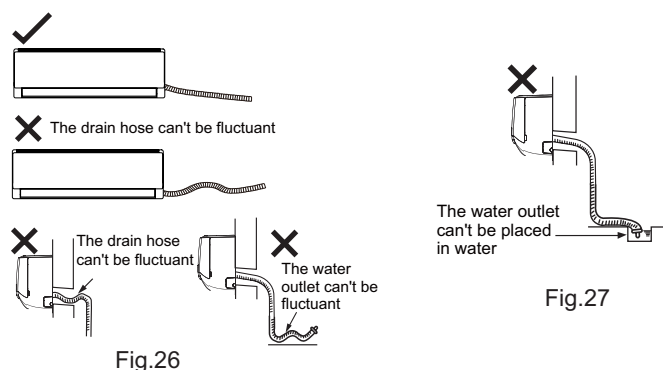

Fig.25

⚠ Note:

- (1) The through-wall height of drain hose shouldn't be higher than the outlet pipe hole of indoor unit.(As show in Fig.25)
- (2) Slant the drain hose slightly downwards. The drain hose can't be curved, raised and fluctuant, etc.(As show in Fig.26)

(3) The water outlet can't be placed in water in order to drain smoothly.(As show in Fig.27)



8.7 Vacuum Pumping and Leak Detection

1. Use Vacuum Pump

- (1) Remove the valve caps on the liquid valve and gas valve and the nut of refrigerant charging vent.
- (2) Connect the charging hose of piezometer to the refrigerant charging vent of gas valve and then connect the other charging hose to the vacuum pump.
- (3) Open the piezometer completely and operate for 10-15min to check if the pressure of piezometer remains in -0.1MPa.
- (4) Close the vacuum pump and maintain this status for 1-2min to check if the pressure of piezometer remains in -0.1MPa. If the pressure decreases, there may be leakage.
- (5) Remove the piezometer, open the valve core of liquid valve and gas valve completely with inner hexagon spanner.
- (6) Tighten the screw caps of valves and refrigerant charging vent.(As show in Fig.28)

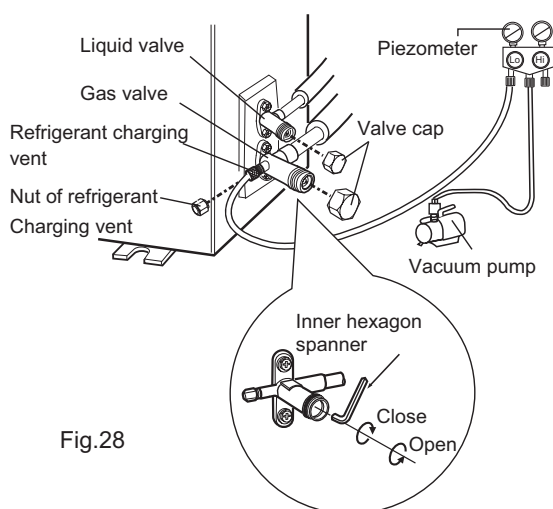

2. Leakage Detection

- (1) With leakage detector:
Check if there is leakage with leakage detector.
- (2) With soap water:
If leakage detector is not available, please use soap water for leakage detection. Apply soap water at the suspected position and keep the soap water for more than 3min. If there are air bubbles coming out of this position, there's a leakage.

8.8 Check after Installation and Test Operation

1. Check after Installation

Check according to the following requirement after finishing installation.

NO.	Items to be checked	Possible malfunction
1	Has the unit been installed firmly?	The unit may drop, shake or emit noise.
2	Have you done the refrigerant leakage test?	It may cause insufficient cooling (heating) capacity.
3	Is heat insulation of pipeline sufficient?	It may cause condensation and water dripping.
4	Is water drained well?	It may cause condensation and water dripping.
5	Is the voltage of power supply according to the voltage marked on the nameplate?	It may cause malfunction or damage the parts.
6	Is electric wiring and pipeline installed correctly?	It may cause malfunction or damage the parts.
7	Is the unit grounded securely?	It may cause electric leakage.
8	Does the power cord follow the specification?	It may cause malfunction or damage the parts.
9	Is there any obstruction in air inlet and air outlet?	It may cause insufficient cooling (heating).
10	The dust and sundries caused during installation are removed?	It may cause malfunction or damaging the parts.
11	The gas valve and liquid valve of connection pipe are open completely?	It may cause insufficient cooling (heating) capacity.

2. Test Operation

- (1) Preparation of test operation
 - The client approves the air conditioner installation.
 - Specify the important notes for air conditioner to the client.
- (2) Method of test operation
 - Put through the power, press ON/OFF button on the remote controller to start operation.
 - Press MODE button to select AUTO, COOL, DRY, FAN and HEAT to check whether the operation is normal or not.
 - If the ambient temperature is lower than 16°C , the air conditioner can't start cooling.

9. Maintenance

9.1 Error Code List

Name of malfunction	Display of indoor unit	Display of lamp (the times of blinking)					
		Indoor			Outdoor		
		R	C	H	Y	R	G
Anti-freezing protection	E2	2			3		
Block or Low pressure of refrigerant system	E3	3				9	
Compressor exhaust high temperature protection	E4	4			7		
AC over-current protection	E5	5			5		
Communication failure between indoor unit and outdoor unit	E6	6					O/U
Anti-high temperature protection	E8	8			6		
	H4			4	6		
No feedback of indoor fan motor	H6	11					
Jumper cap malfunction protection	C5	15					
Indoor unit and outdoor unit doesn't match	LP	19			16		
Outdoor DC fan motor malfunction	L3	23				14	
Power protection	L9	20			9		
Gathering refrigerant	Fo	1	1				
Indoor ambient sensor open or short circuit	F1		1				
Indoor tube sensor open or short circuit	F2		2				
Outdoor ambient sensor open or short circuit	F3		3			6	
Outdoor tube sensor open or short circuit	F4		4			5	
Exhaust sensor open or short circuit	F5		5			7	
Overload limit / drop frequency	F6		6			3	
Over current limit / drop frequency	F8		8			1	
High exhaust temperature limit / drop frequency	F9		9			2	
Refrigerant leakage protection	F0		10			9	
Anti-freezing limit / drop frequency	FH		2	2		4	
Defrosting	H1			1	2		
Compressor overload protection	H3			3	8		
IPM protection	H5			5	4		
Module temperature is too high	H5			5	10		
PFC protection	HC			6	14		
Loading EEPROM malfunction	EE			15	11		
High PN voltage protection	PH		11		13		
Low PN voltage protection	PL			21	12		
4-way valve reversal abnormal	U7		20				
DRED1 / DRED2 / DRED3	d1/d2/d3						
Compressor Min frequency in test state	P0						
Compressor rated frequency in test state	P1						
Compressor maximum frequency in test state	P2						
Compressor intermediate frequency in test state	P3						
Compressor is running(normal)					1		
The temperature for turning on the unit is reached(normal)						8	
Frequency limiting (module temperature)	EU		6	6		11	
Frequency limiting (power)	LU		24			13	

Notes: R(Indoor)--Running C--Cooling H--Heating Y--Yellow R(Outdoor)--Red G--Green
 O/U--OFF or Unblink The display difference between Fo and F0 is 'o' is the bottom part of figure 8

9.2 Troubleshooting for Main Malfunction

•Indoor unit:

1. Malfunction of Temperature Sensor F1, F2

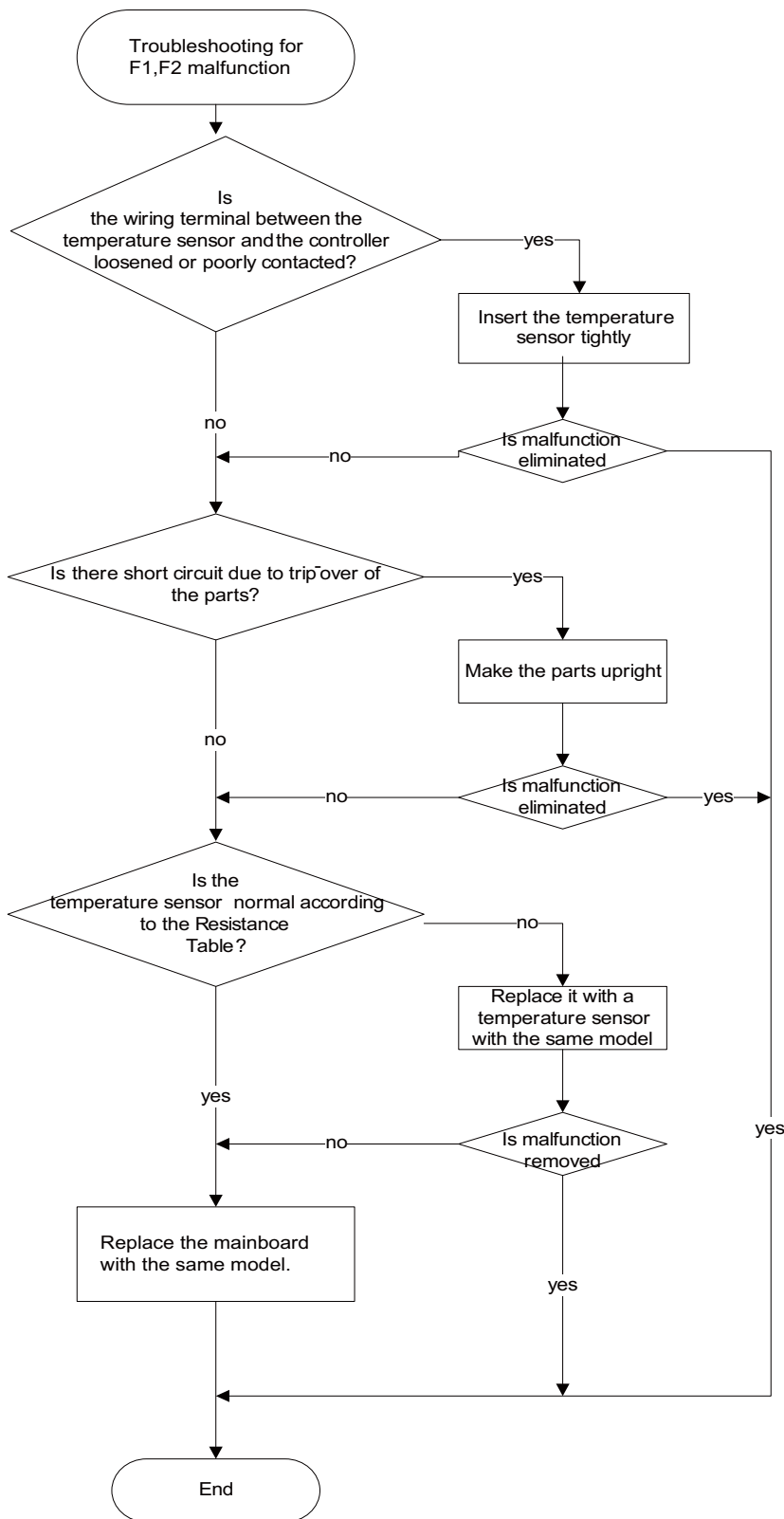

2. Malfunction of Blocked Protection of IDU Fan Motor H6

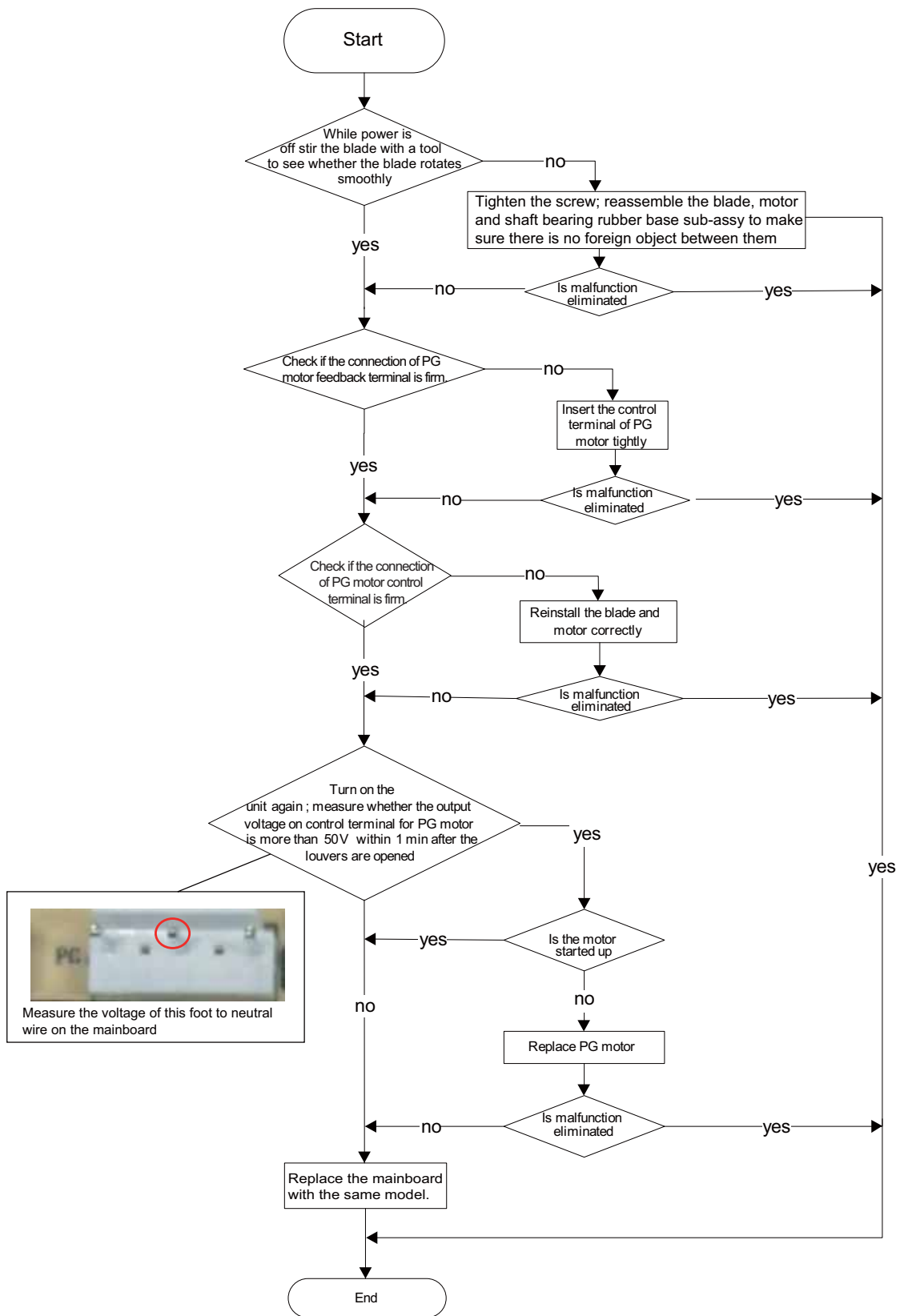

3. Malfunction of Protection of Jumper Cap C5

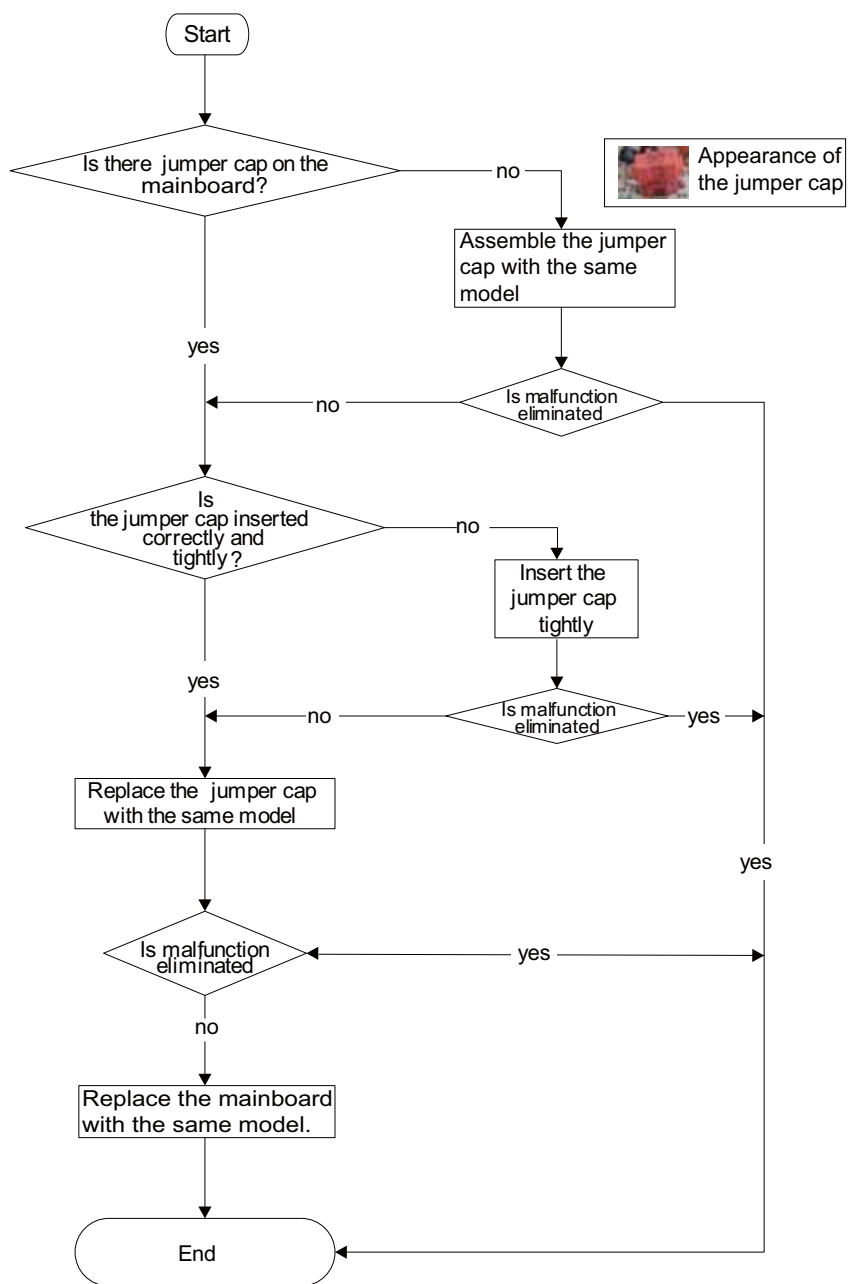

4. Communication malfunction E6

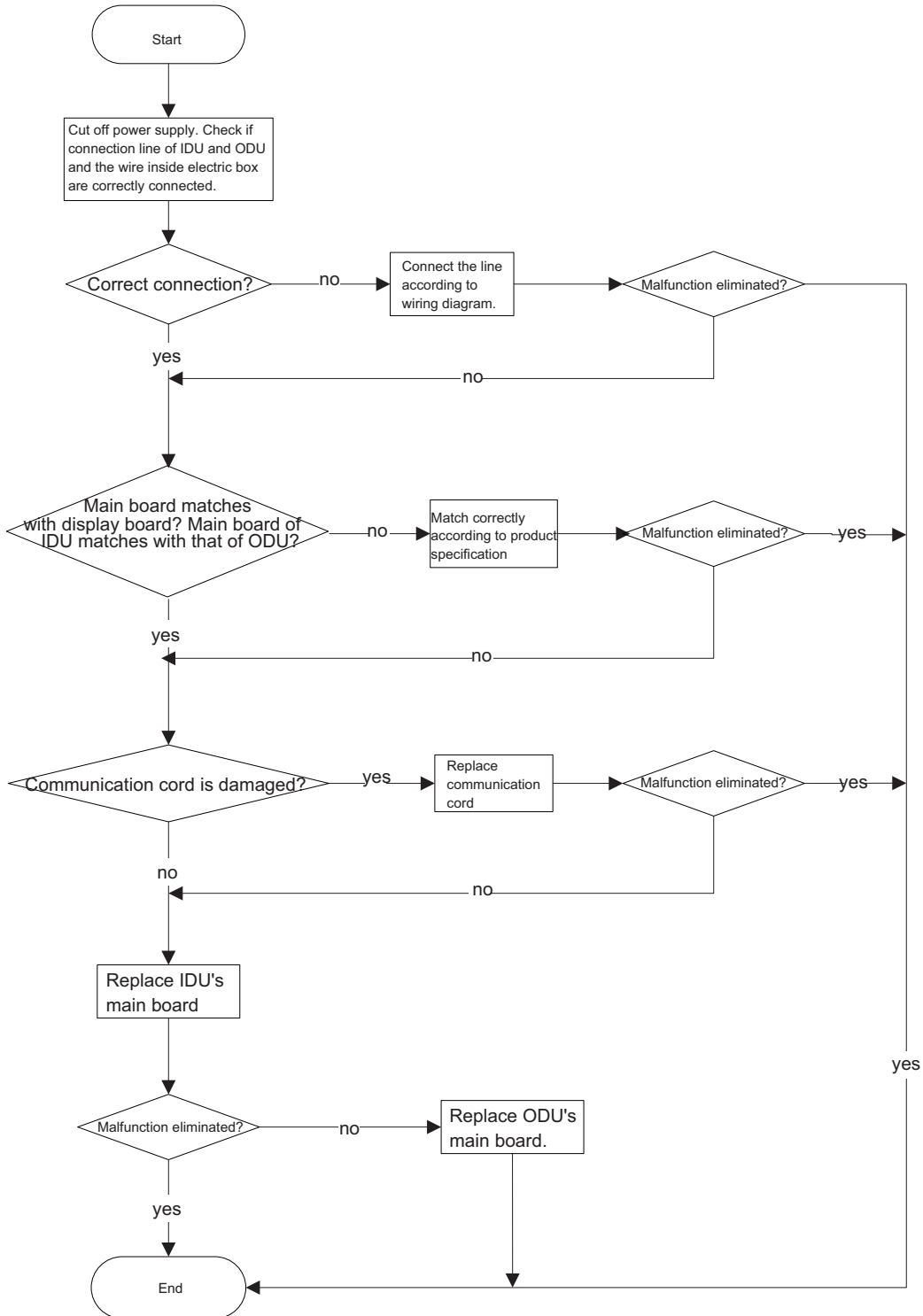

●Outdoor unit:

(1) Capacitor charge fault (Fault with outdoor unit) (AP1 below refers to the outdoor control panel)

Main Check Points:

- Use AC voltmeter to check if the voltage between terminal L and N on the wiring board is within 210VAC~240VAC.
- Is the reactor (L) correctly connected? Is the connection loose or fallen? Is the reactor (L) damaged?

Fault diagnosis process:

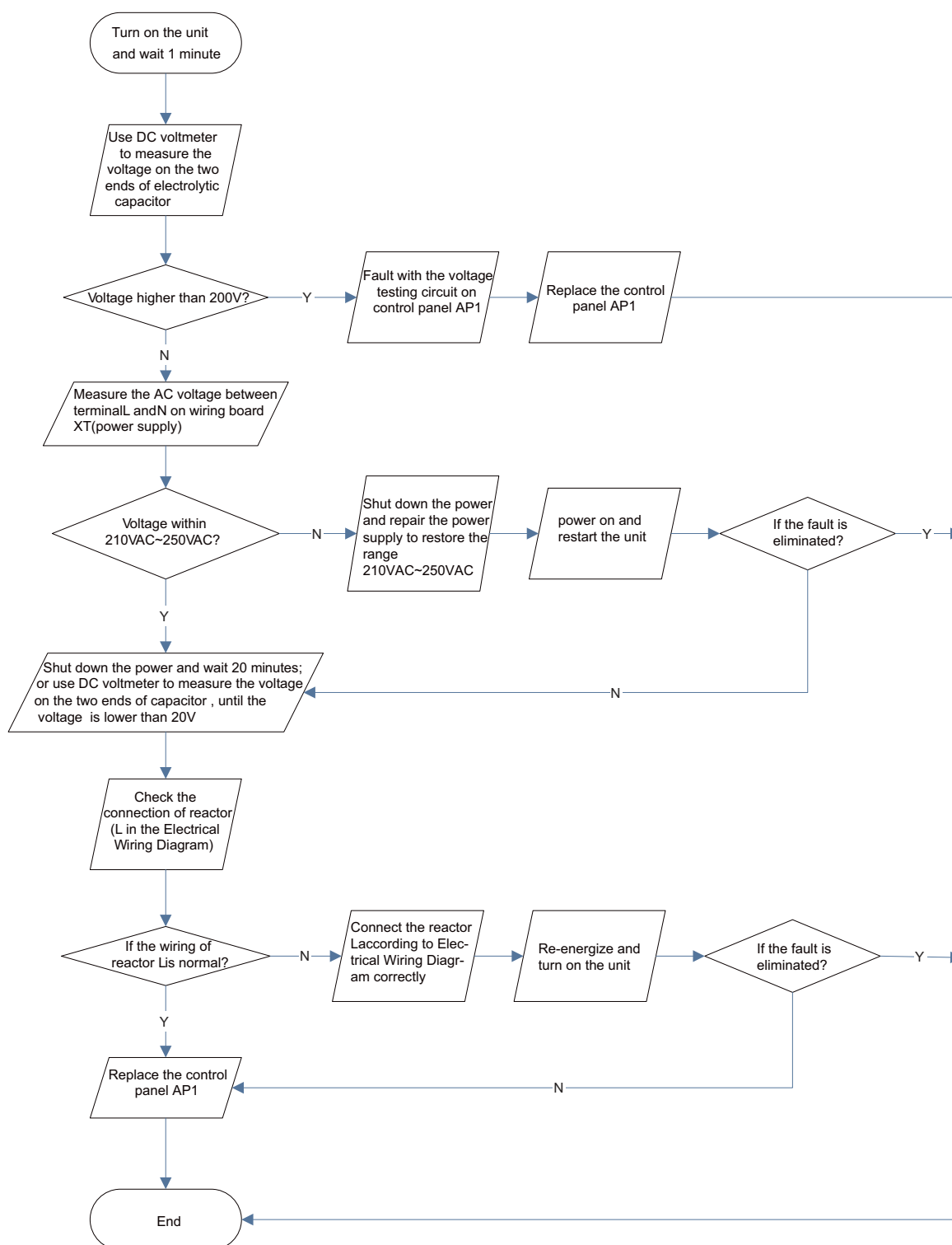

(2) IPM Protection, Out-of-step Fault, Compressor Phase Overcurrent (AP1 below refers to the outdoor control panel)

Main check points:

- Is the connection between control panel AP1 and compressor COMP secure? Loose? Is the connection in correct order?
- Is the voltage input of the machine within normal range? (Use AC voltmeter to measure the voltage between terminal L and N on the wiring board XT)
- Is the compressor coil resistance normal? Is the insulation of compressor coil against the copper tube in good condition?
- Is the working load of the machine too high? Is the radiation good?
- Is the charge volume of refrigerant correct?

Fault diagnosis process:

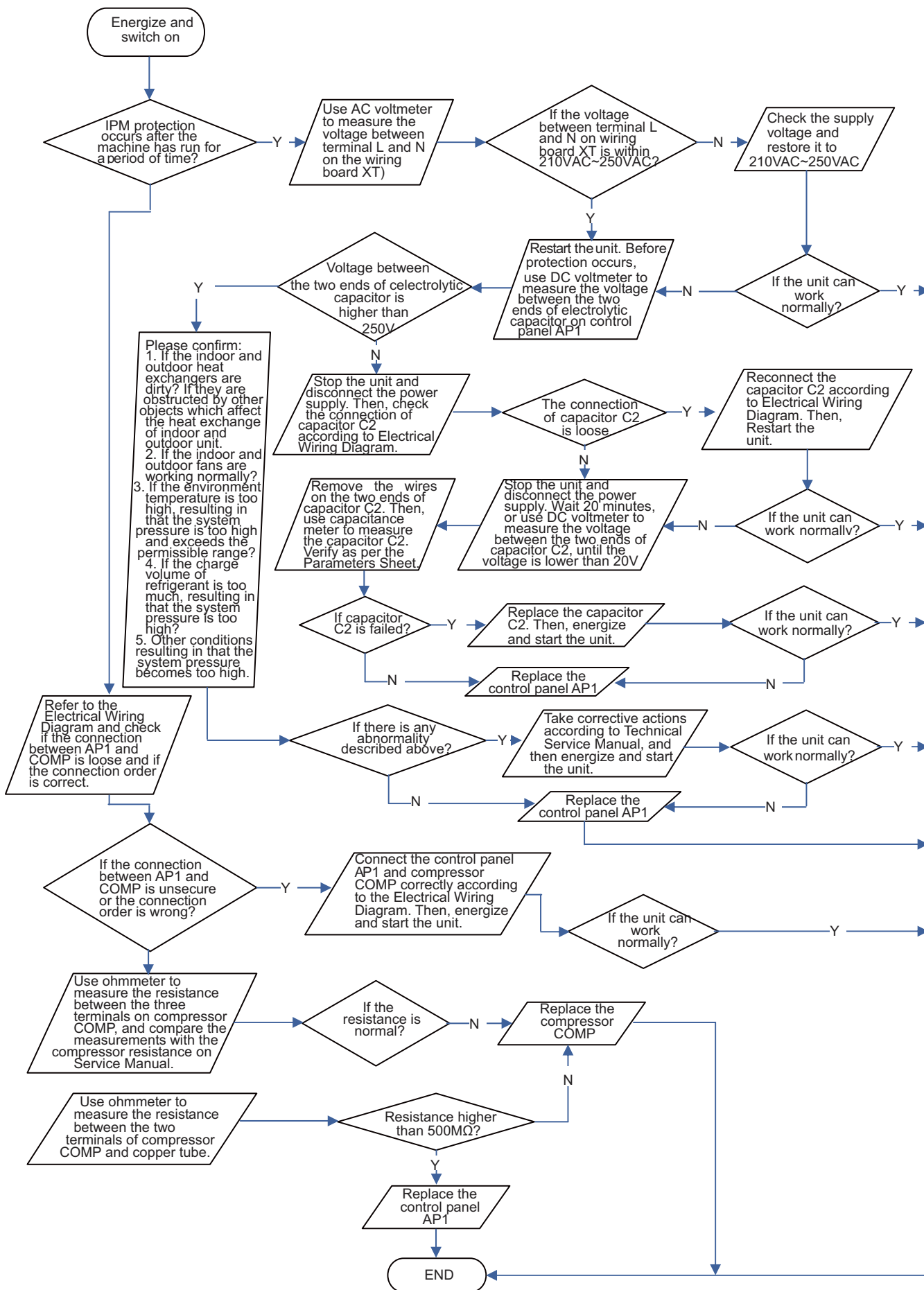

(3) High temperature and overload protection diagnosis (AP1 hereinafter refers to the control board of the outdoor unit)

Mainly detect:

- Is outdoor ambient temperature in normal range?
- Are the outdoor and indoor fans operating normally?
- Is the heat dissipation environment inside and outside the unit good?

Fault diagnosis process:

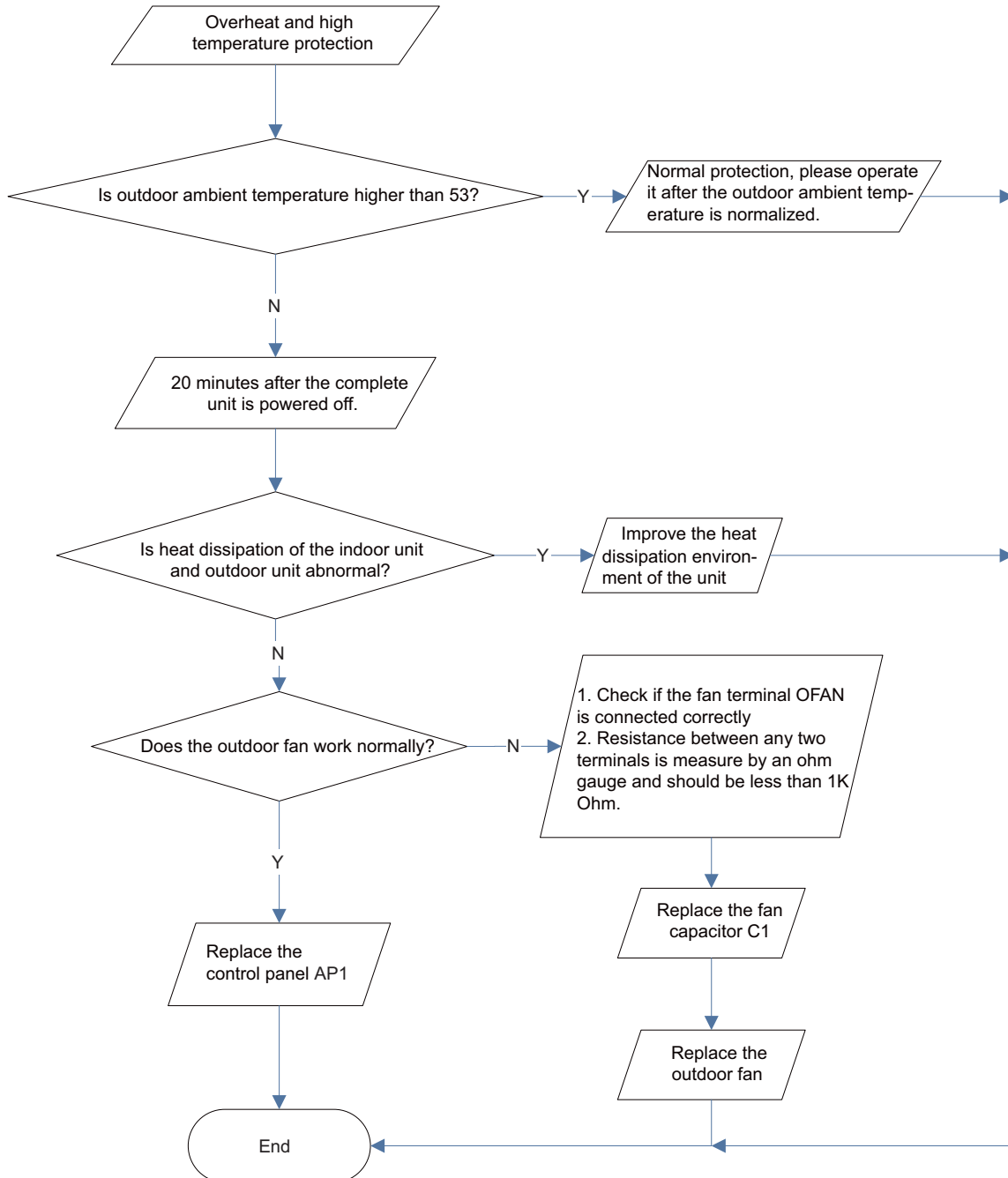

(4) Start-up failure (following AP1 for outdoor unit control board)

Mainly detect:

- Whether the compressor wiring is connected correct?
- Is compressor broken?
- Is time for compressor stopping enough?

Fault diagnosis process:

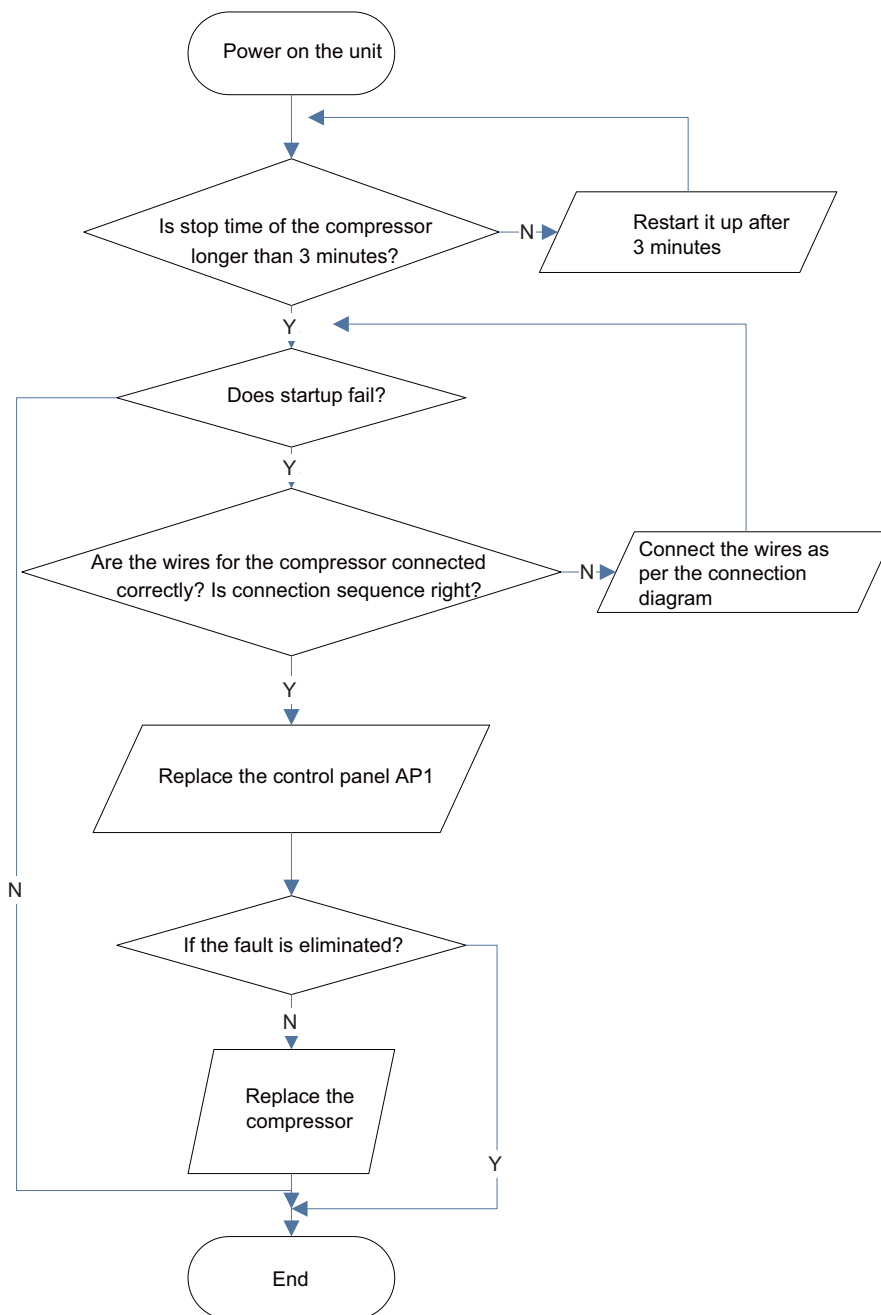

(5) Out of step diagnosis for the compressor (AP1 hereinafter refers to the control board of the outdoor unit)

Mainly detect:

- Is the system pressure too high?
- Is the input voltage too low?

Fault diagnosis process:

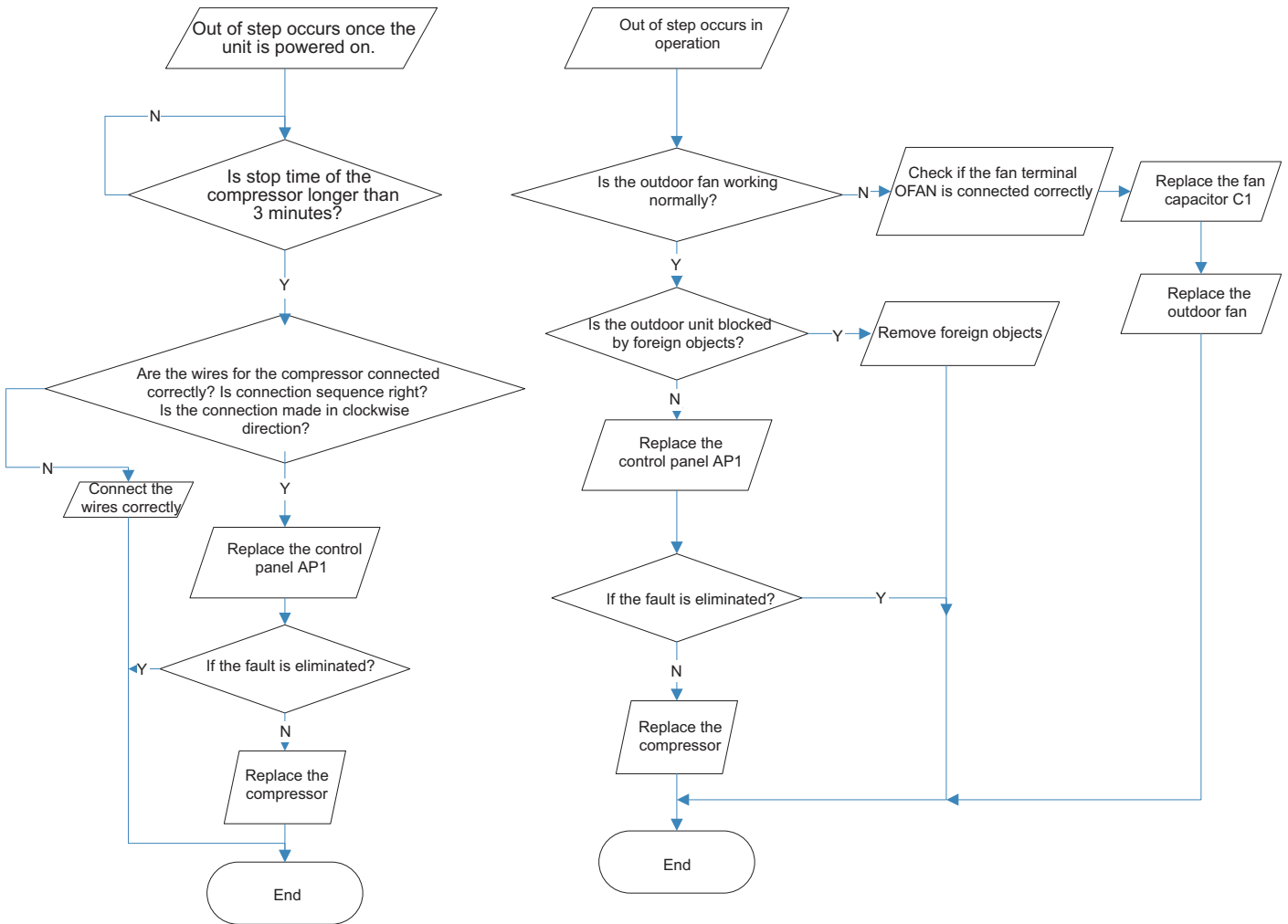

(6) Overload and air exhaust malfunction diagnosis (following AP1 for outdoor unit control board)

Mainly detect:

- Is the PMV connected well or not? Is PMV damaged?
- Is refrigerant leaked?

Fault diagnosis process:

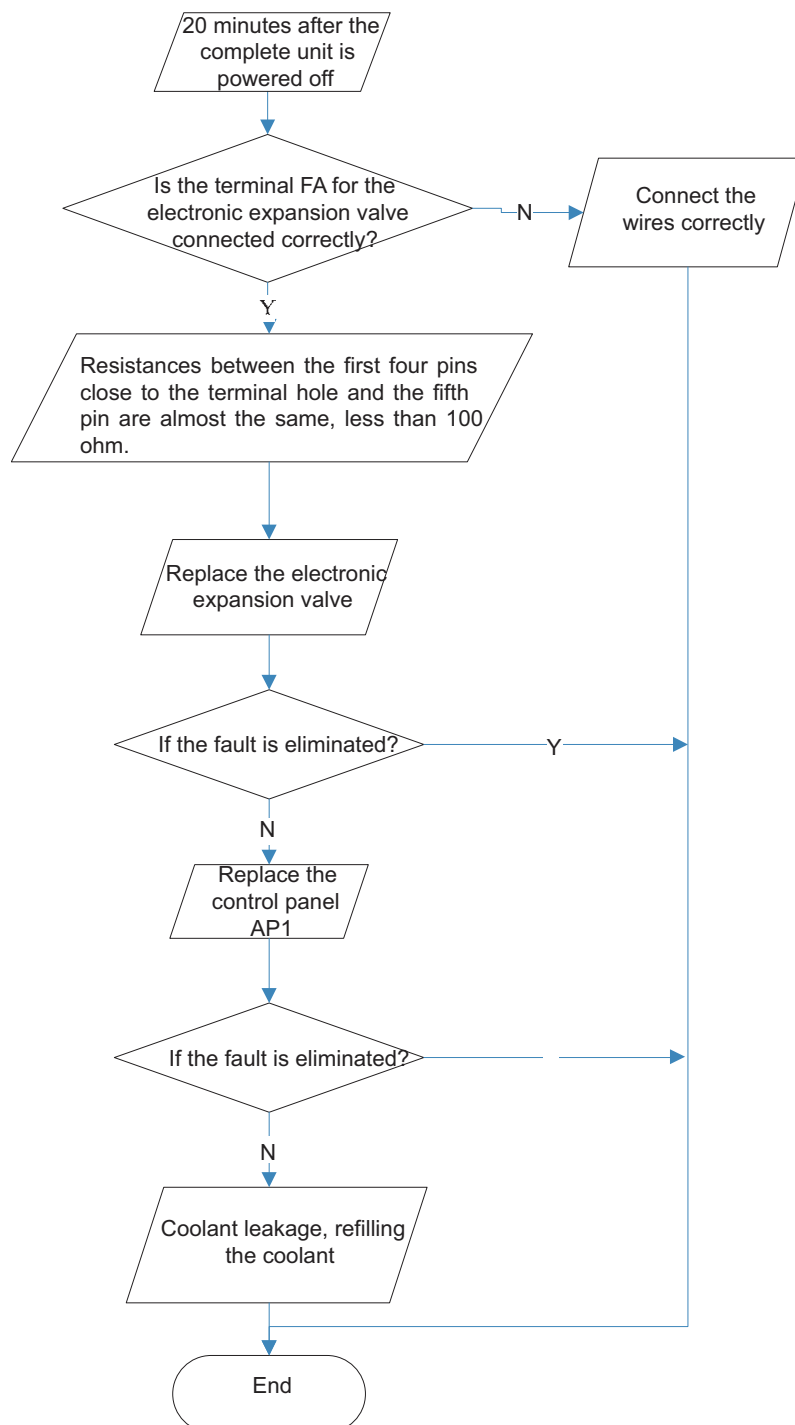

(7) Power factor correct or (PFC) fault (a fault of outdoor unit) (AP1 hereinafter refers to the control board of the outdoor unit)

Mainly detect:

- Check if the reactor (L) of the outdoor unit and the PFC capacitor are broken

Fault diagnosis process:

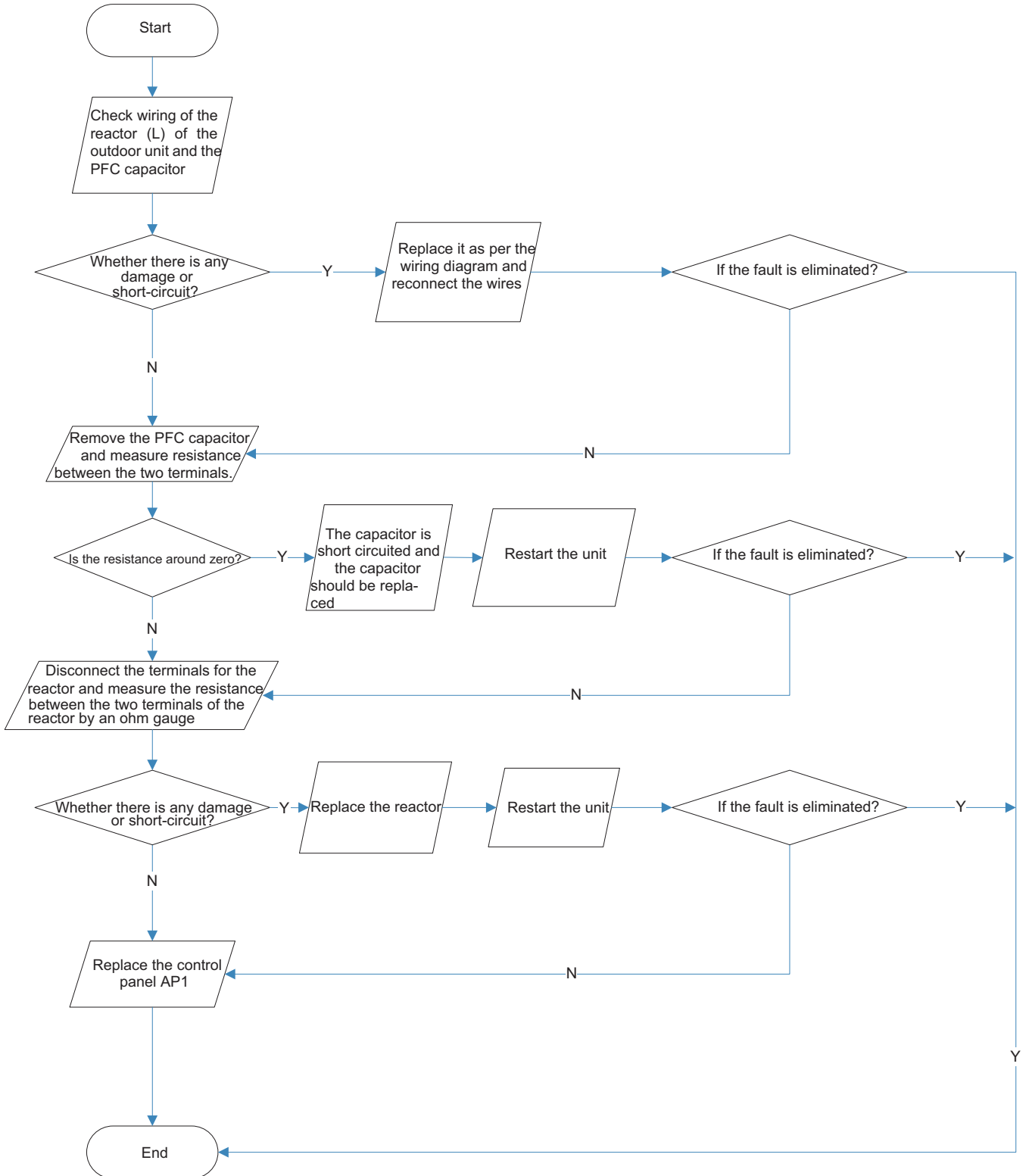

(8) Communication malfunction: (following AP1 for outdoor unit control board)

Mainly detect:

- Is there any damage for the indoor unit mainboard communication circuit? Is communication circuit damaged?
- Detect the indoor and outdoor units connection wire and indoor and outdoor units inside wiring is connect well or not, if is there any damage?

Fault diagnosis process:

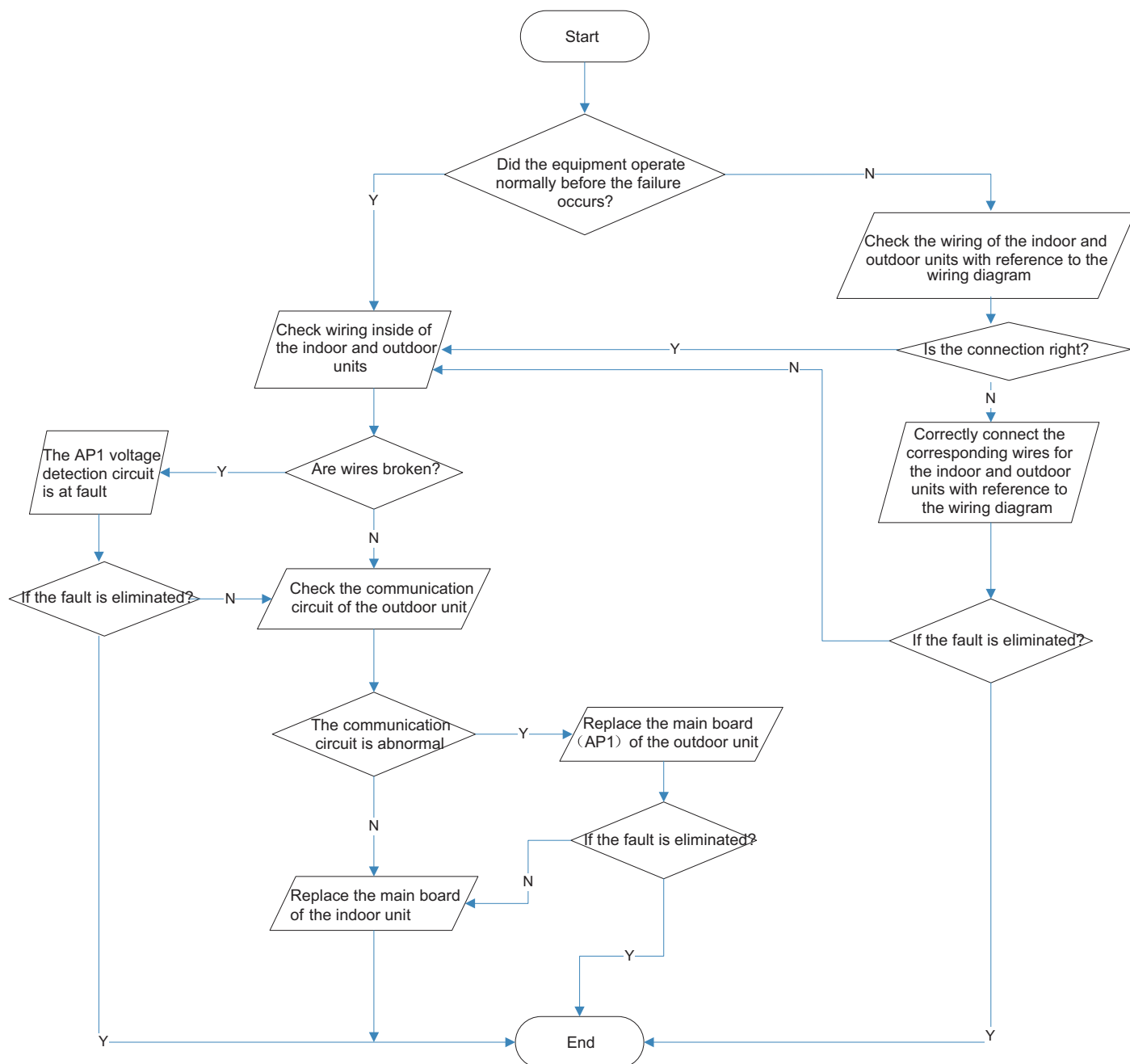

9.3 Troubleshooting for Normal Malfunction

1. Air Conditioner Can't be Started Up

Possible Causes	Discriminating Method (Air conditioner Status)	Troubleshooting
No power supply, or poor connection for power plug	After energization, operation indicator isn't bright and the buzzer can't give out sound	Confirm whether it's due to power failure. If yes, wait for power recovery. If not, check power supply circuit and make sure the power plug is connected well.
Wrong wire connection between indoor unit and outdoor unit, or poor connection for wiring terminals	Under normal power supply circumstances, operation indicator isn't bright after energization	Check the circuit according to circuit diagram and connect wires correctly. Make sure all wiring terminals are connected firmly
Electric leakage for air conditioner	After energization, room circuit breaker trips off at once	Make sure the air conditioner is grounded reliably Make sure wires of air conditioner is connected correctly Check the wiring inside air conditioner. Check whether the insulation layer of power cord is damaged; if yes, place the power cord.
Model selection for air switch is improper	After energization, air switch trips off	Select proper air switch
Malfunction of remote controller	After energization, operation indicator is bright, while no display on remote controller or buttons have no action.	Replace batteries for remote controller Repair or replace remote controller

2. Poor Cooling (Heating) for Air Conditioner

Possible Causes	Discriminating Method (Air conditioner Status)	Troubleshooting
Set temperature is improper	Observe the set temperature on remote controller	Adjust the set temperature
Rotation speed of the IDU fan motor is set too low	Small wind blow	Set the fan speed at high or medium
Filter of indoor unit is blocked	Check the filter to see it's blocked	Clean the filter
Installation position for indoor unit and outdoor unit is improper	Check whether the installation position is proper according to installation requirement for air conditioner	Adjust the installation position, and install the rainproof and sunproof for outdoor unit
Refrigerant is leaking	Discharged air temperature during cooling is higher than normal discharged wind temperature; Discharged air temperature during heating is lower than normal discharged wind temperature; Unit's pressure is much lower than regulated range	Find out the leakage causes and deal with it. Add refrigerant.
Malfunction of 4-way valve	Blow cold wind during heating	Replace the 4-way valve
Malfunction of capillary	Discharged air temperature during cooling is higher than normal discharged wind temperature; Discharged air temperature during heating is lower than normal discharged wind temperature; Unit's pressure is much lower than regulated range. If refrigerant isn't leaking, part of capillary is blocked	Replace the capillary
Flow volume of valve is insufficient	The pressure of valves is much lower than that stated in the specification	Open the valve completely
Malfunction of horizontal louver	Horizontal louver can't swing	Refer to point 3 of maintenance method for details
Malfunction of the IDU fan motor	The IDU fan motor can't operate	Refer to troubleshooting for H6 for maintenance method in details
Malfunction of the ODU fan motor	The ODU fan motor can't operate	Refer to point 4 of maintenance method for details
Malfunction of compressor	Compressor can't operate	Refer to point 5 of maintenance method for details

3. Horizontal Louver Can't Swing

Possible Causes	Discriminating Method (Air conditioner Status)	Troubleshooting
Wrong wire connection, or poor connection	Check the wiring status according to circuit diagram	Connect wires according to wiring diagram to make sure all wiring terminals are connected firmly
Stepping motor is damaged	Stepping motor can't operate	Repair or replace stepping motor
Main board is damaged	Others are all normal, while horizontal louver can't operate	Replace the main board with the same model

4. ODU Fan Motor Can't Operate

Possible causes	Discriminating method (air conditioner status)	Troubleshooting
Wrong wire connection, or poor connection	Check the wiring status according to circuit diagram	Connect wires according to wiring diagram to make sure all wiring terminals are connected firmly
Capacity of the ODU fan motor is damaged	Measure the capacity of fan capacitor with an universal meter and find that the capacity is out of the deviation range indicated on the nameplate of fan capacitor.	Replace the capacity of fan
Power voltage is a little low or high	Use universal meter to measure the power supply voltage. The voltage is a little high or low	Suggest to equip with voltage regulator
Motor of outdoor unit is damaged	When unit is on, cooling/heating performance is bad and ODU compressor generates a lot of noise and heat.	Change compressor oil and refrigerant. If no better, replace the compressor with a new one

5. Compressor Can't Operate

Possible causes	Discriminating method (air conditioner status)	Troubleshooting
Wrong wire connection, or poor connection	Check the wiring status according to circuit diagram	Connect wires according to wiring diagram to make sure all wiring terminals are connected firmly
Capacity of compressor is damaged	Measure the capacity of fan capacitor with an universal meter and find that the capacity is out of the deviation range indicated on the nameplate of fan capacitor.	Replace the compressor capacitor
Power voltage is a little low or high	Use universal meter to measure the power supply voltage. The voltage is a little high or low	Suggest to equip with voltage regulator
Coil of compressor is burnt out	Use universal meter to measure the resistance between compressor terminals and it's 0	Repair or replace compressor
Cylinder of compressor is blocked	Compressor can't operate	Repair or replace compressor

6. Air Conditioner is Leaking

Possible causes	Discriminating method (air conditioner status)	Troubleshooting
Drain pipe is blocked	Water leaking from indoor unit	Eliminate the foreign objects inside the drain pipe
Drain pipe is broken	Water leaking from drain pipe	Replace drain pipe
Wrapping is not tight	Water leaking from the pipe connection place of indoor unit	Wrap it again and bundle it tightly

7. Abnormal Sound and Vibration

Possible causes	Discriminating method (air conditioner status)	Troubleshooting
When turn on or turn off the unit, the panel and other parts will expand and there's abnormal sound	There's the sound of "PAPA"	Normal phenomenon. Abnormal sound will disappear after a few minutes.
When turn on or turn off the unit, there's abnormal sound due to flow of refrigerant inside air conditioner	Water-running sound can be heard	Normal phenomenon. Abnormal sound will disappear after a few minutes.
Foreign objects inside the indoor unit or there're parts touching together inside the indoor unit	There's abnormal sound fro indoor unit	Remove foreign objects. Adjust all parts' position of indoor unit, tighten screws and stick damping plaster between connected parts
Foreign objects inside the outdoor unit or there're parts touching together inside the outdoor unit	There's abnormal sound fro outdoor unit	Remove foreign objects. Adjust all parts' position of outdoor unit, tighten screws and stick damping plaster between connected parts
Short circuit inside the magnetic coil	During heating, the way valve has abnormal electromagnetic sound	Replace magnetic coil
Abnormal shake of compressor	Outdoor unit gives out abnormal sound	Adjust the support foot mat of compressor, tighten the bolts
Abnormal sound inside the compressor	Abnormal sound inside the compressor	If add too much refrigerant during maintenance, please reduce refrigerant properly. Replace compressor for other circumstances.

NO.	Description	Part Code		Qty
		GWC09QB-D3DNA6E/(LC)	GWH09QB-D3DNA6E/(LCLH)	
		Product Code		
		CB427N01900	CB427N02200	
1	Front Panel	2002269601S	2002269601S	1
2	Filter Sub-Assy	11122219	11122219	2
3	Display Board	30565265	30565265	1
4	Front Case Assy	00000200069	00000200069	1
5	Guide Louver	1051276301	1051276301	1
6	Helicoid Tongue	2611250802	2611250802	1
7	Left Axile Bush	10512037	10512037	1
8	Rear Case assy	00000100066	00000100066	1
9	Drainage Hose	0523001408	0523001408	1
10	Ring of Bearing	26152022	26152022	1
11	O-Gasket sub-assy of Bearing	7651205102	7651205102	1
12	Evaporator Supper	24212180	24212180	1
13	Cold Plasma Generator	/	/	/
14	Evaporator Assy	0100200004406	0100200004406	1
15	Wall Mounting Frame	01252043	01252043	1
16	Cross Flow Fan	10352059	10352059	1
17	Fan Motor	1501208905	1501208905	1
18	Connecting pipe clamp	2611216401	2611216401	1
19	Rubber Plug (Water Tray)	76712012	76712012	1
20	SteppingMotor	1521212901	1521212901	1
21	Crank	73012005	73012005	1
22	Electric Box Assy	10000201638	10000201639	1
23	Axile Bush	10542036	10542036	1
24	Terminal Board	4201123303	4201123303	1
25	Jumper	4202021911	4202021911	1
26	Main Board	30138000660	30138000659	1
27	Screw Cover	2425203001	2425203001	1
28	Electric Box Cover Sub-Assy	0140206501	0140206501	1
29	Shield Cover of Electric Box Cover	01592150	01592150	1
30	Electric Box Cover	2011220701	2011220701	1
31	Power Cord	/	/	/
32	Connecting Cable	/	/	/
33	Remote Controller	30510475	30510475	1

Above data is subject to change without notice.

NO.	Description	Part Code		Qty
		GWC12QC-D3DNA6E/I(LC)	GWH12QC-D3DNA6E/I(LCLH)	
	Product Code	CB427N01800	CB427N02100	
1	Front Panel	2002266101S	2002266101S	1
2	Filter Sub-Assy	11122468	11122468	2
3	Display Board	30565265	30565265	1
4	Front Case Assy	2002273101	2002273101	1
5	Guide Louver	1051293101	1051293101	1
6	Helicoid Tongue	26112507	26112507	1
7	Left Axile Bush	10512037	10512037	1
8	Rear Case assy	22202375	22202375	1
9	Drainage Hose	05230014	05230014	1
10	Ring of Bearing	26152022	26152022	1
11	O-Gasket sub-assy of Bearing	7651205102	7651205102	1
12	Evaporator Supper	24212179	24212179	1
13	Cold Plasma Generator	/	/	/
14	Evaporator Assy	0100297601	0100297601	1
15	Wall Mounting Frame	01252484	01252484	1
16	Cross Flow Fan	10352056	10352056	1
17	Fan Motor	1501214601	1501214601	1
18	Connecting pipe clamp	2611216401	2611216401	1
19	Rubber Plug (Water Tray)	76712012	76712012	1
20	SteppingMotor	1521210701	1521210701	1
21	Crank	73012005	73012005	1
22	Electric Box Assy	10000201640	10000201641	1
23	Axile Bush	10542036	10542036	1
24	Terminal Board	4201123303	4201123303	1
25	Jumper	4202021917	4202021917	1
26	Main Board	30138000655	30138000656	1
27	Screw Cover	2425203001	2425203001	1
28	Electric Box Cover Sub-Assy	0140206501	0140206501	1
29	Shield Cover of Electric Box Cover	01592150	01592150	1
30	Electric Box Cover	2011220701	2011220701	1
31	Power Cord	/	/	/
32	Connecting Cable	/	/	/
33	Remote Controller	30510475	30510475	1

Above data is subject to change without notice.

10.2 Outdoor Unit

Cooling only models

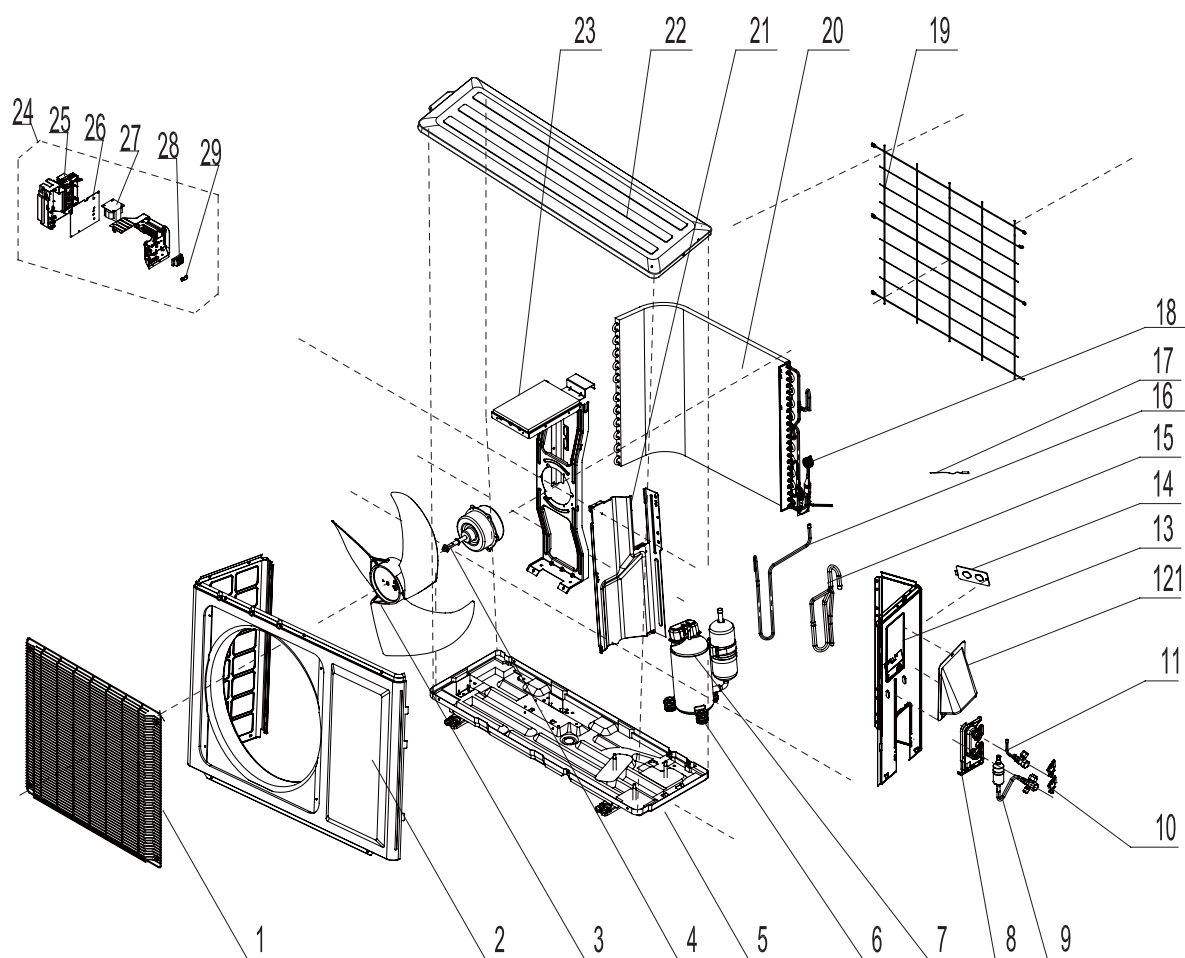

NO.	Description	Part Code		Qty
		GWC09QB-D3DNA6E/O(LC)	GWC12QC-D3DNA6E/O(LC)	
	Product Code	CB427W01900	CB427W01800	
1	Front Grill	01473012	01473012	1
2	Front Panel Assy	0153304804	0153304804	1
3	Axial Flow Fan	10333004	10333004	1
4	Fan Motor	1501306723	1501306723	1
5	Chassis Sub-assy	0170000009501P	02803187P	1
6	Compressor Gasket	76713027	76713027	3
7	Compressor and fittings	00103892	00103892	1
8	Valve Support	0171314201P	0171314201P	1
9	Cut off Valve Assy	07133474	07133474	1
10	Valve Support Block	26113017	26113017	2
11	Valve	07100003	07133082	1
12	Cable Cross Plate 2	02123014P	02123014P	1
13	Right Side Plate Assy	013030713	013030713	1
14	Cover of pass wire	01413069	01413069	1
15	Inhalation Tube Sub-assy	03001000262	03001000262	1
16	Discharge Tube	03500800572	03500800570	1
17	Temperature Sensor	3900030805	3900030805	1
18	Capillary Sub-assy	03000600338	03000600339	1
19	Rear Grill	01473009	01473009	1
20	Condenser Assy	01100200359	01100200360	1
21	Clapboard Sub-Assy	0123338502	0123338502	1
22	Top Cover Sub-Assy	01253073	01253073	1
23	Motor Support	01703104	0170310401	1
24	Electric Box Assy	10000100289	10000100290	1
25	Reactor	43130184	43130184	1
26	Electric Box Cover Sub-Assy	10000500128	10000500129	1
27	Main Board	30138000678	30138000680	1
28	Terminal Board	42010313	42010313	1
29	Wire Clamp	71010003	71010003	1

Above data is subject to change without notice.

Cooling and heating models

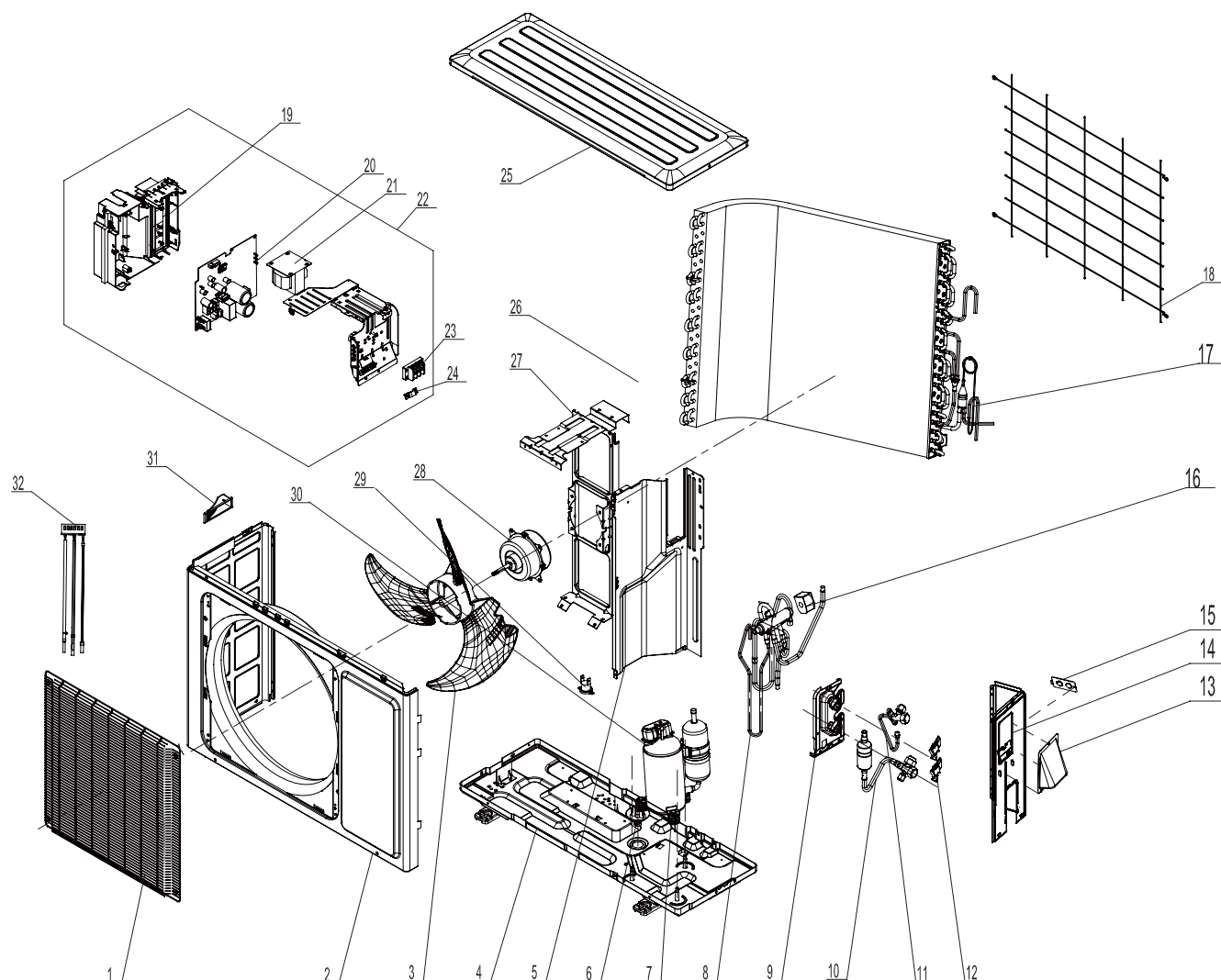

NO.	Description	Part Code		Qty
		GWH09QC-A3DNA1D/O	GWH12QC-D3DNA6E/O(LCLH)	
	Product Code	CB419W03900	CB427W02100	
1	Front Grill	01473012	01473012	1
2	Front Panel Assy	0153304804	0153304804	1
3	Axial Flow Fan	10333004	10333004	1
4	Chassis Sub-assy	01700000095P	01700000081P	1
5	Clapboard Sub-Assy	0123338502	0123338502	1
6	Drainage Connector	06123401	06123401	1
7	Compressor Gasket	76713027	76713027	3
8	4-Way Valve Assy	03073369	03073277	1
9	Valve Support	0171314201P	0171314201P	1
10	Cut off Valve Assy	07133474	07133474	1
11	Valve	07100003	07133082	1
12	Valve Support Block	26113017	26113017	2
13	Cover of Pass Wire	01413069	01413069	1
14	Right Side Plate Assy	013030713	013030713	1
15	Cable Cross Plate 2	02123014P	02123014P	1
16	Magnet Coil	4300040050	4300040050	1
17	Capillary Sub-assy	03000600331	03000600327	1
18	Rear Grill	01473009	01473009	1
19	Electric Box	20113033	20113033	1
20	Main Board	30138000679	30138000677	1
21	Reactor	43130184	43130184	1
22	Electric Box Assy	10000100292	10000100291	1
23	Terminal Board	42010313	42010313	1
24	Wire Clamp	71010003	71010003	1
25	Top Cover Sub-Assy	01253073	01253073	1
26	Condenser Assy	01100200349	01100200346	1
27	Motor Support	01703104	0170310401	1
28	Fan Motor	1501306723	1501306723	1
29	Compressor Overload Protector(External)	00183111	00183111	1
30	Compressor and Fittings	00103892	00103892	1
31	Small Handle	26233100	26233100	1
32	Temperature Sensor	3900030805	3900030805	1

Above data is subject to change without notice.

11. Removal Procedure

⚠ Warning: Be sure to wait for a minimum of 20 minutes after turning off all power supplies and discharge the refrigerant completely before removal.

11.1 Removal Procedure of Indoor Unit

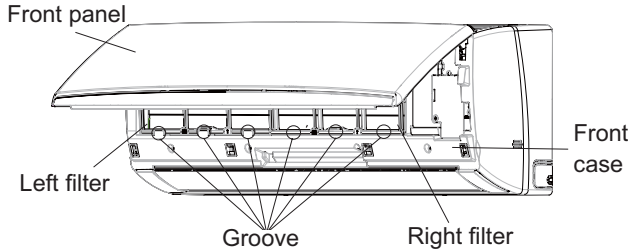
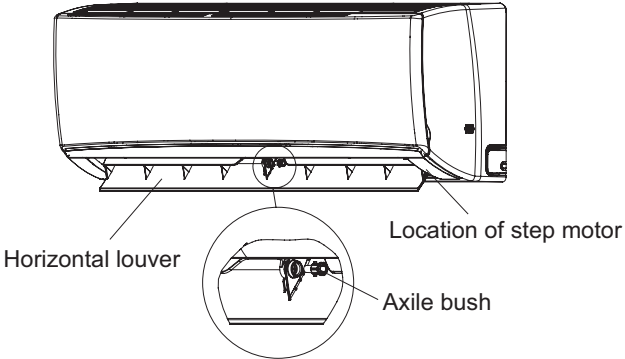
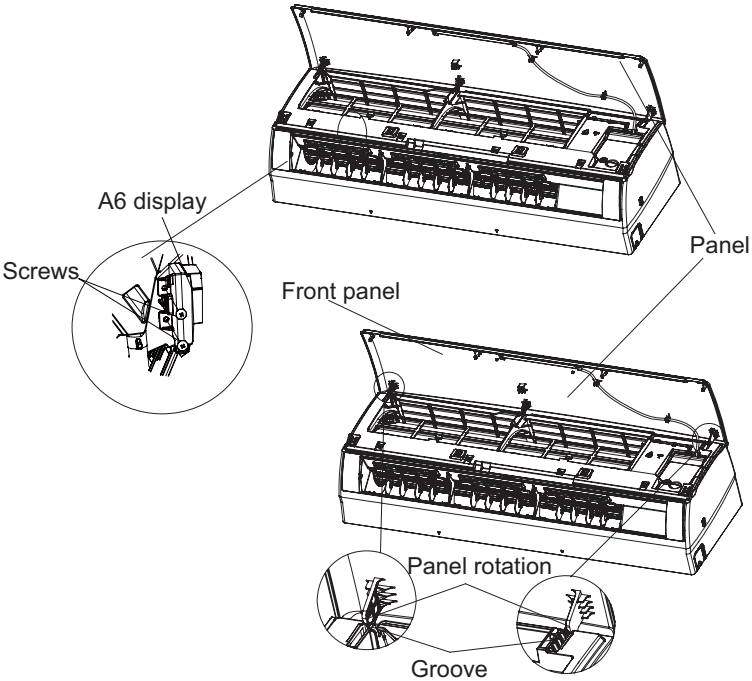
Step	Procedure	
1. Remove filter assembly	<p>Open the front panel. Push the left filter and right filter until they are separate from the groove on the front panel. Remove the left filter and right filter respectively.</p>	
2. Remove horizontal louver	<p>Push out the axle bush on horizontal louver. Bend the horizontal louver with hand and then separate the horizontal louver from the crankshaft of step motor to remove it.</p>	
3. Remove panel	<p>a (1)A1& A5 display: Screw off the 2 screws that are locking the display board. Separate the display board from the front panel. (2)A6 display: Screw off the 2 screws that are locking the display board.</p> <p>b Separate the panel rotation shaft from the groove fixing the front panel and then removes the front panel.</p>	

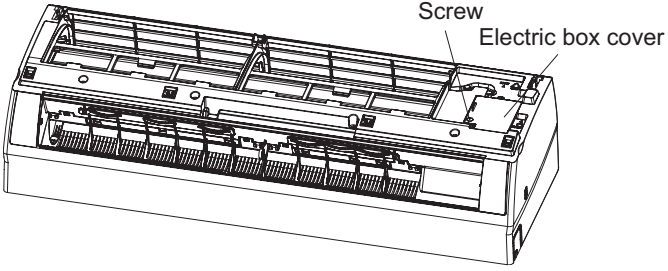
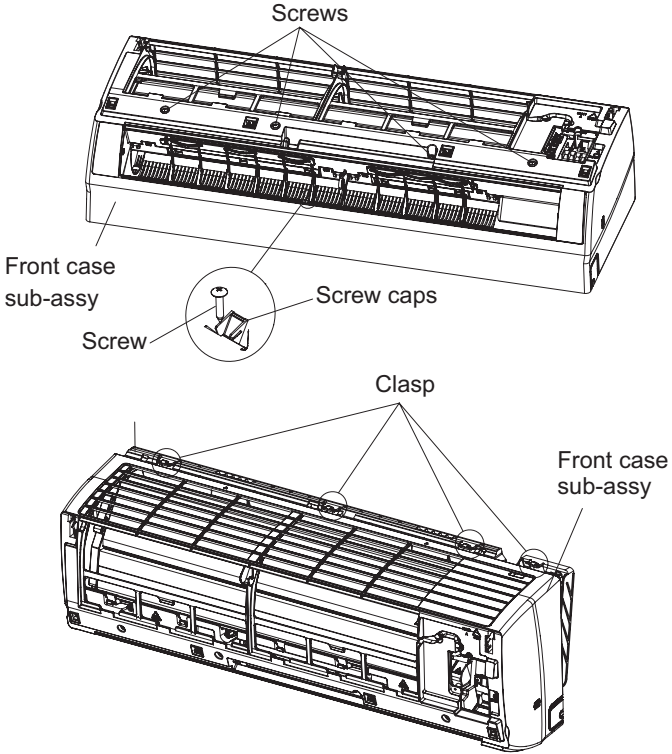
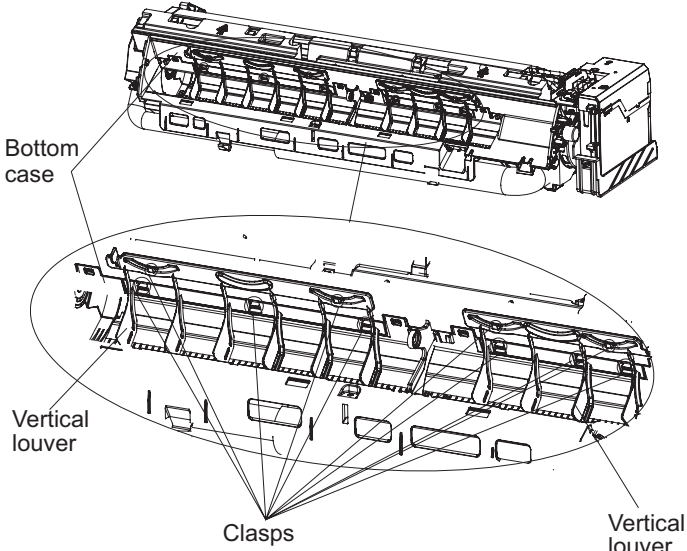
Step	Procedure
4. Remove electric box cover	<p>Remove the screws on the electric box cover to remove the electric box cover.</p> 
5. Remove front case sub-assy	<p>a Remove the screws fixing front case.</p> <p>Note: 1.Open the screw caps before removing the screws around the air outlet. 2.The quantity of screws fixing the front case sub-assy is different for different models.</p> <p>b Loosen the connection clasps between front case sub-assy and bottom case. Lift up the front case sub-assy and take it out.</p> 
6. Remove vertical louver	<p>Loosen the connection clasps between vertical louver and bottom case to remove vertical louver.</p> 

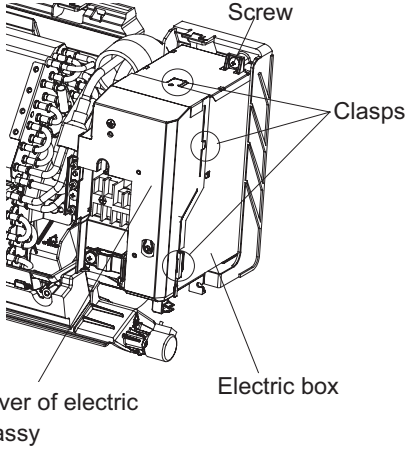
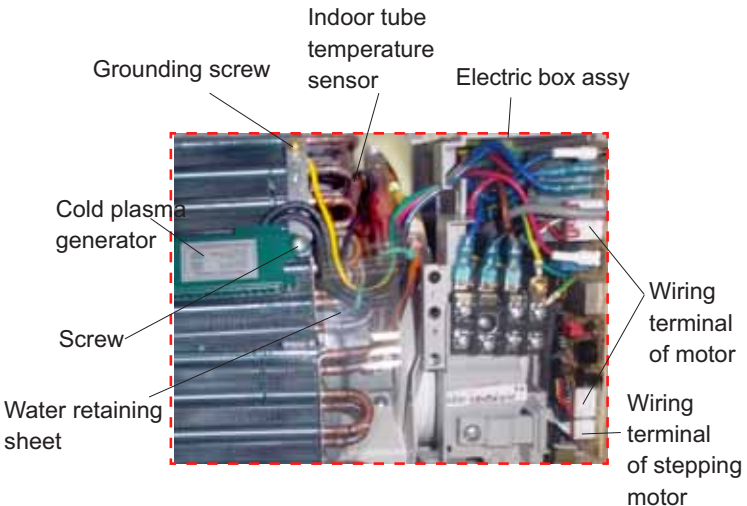
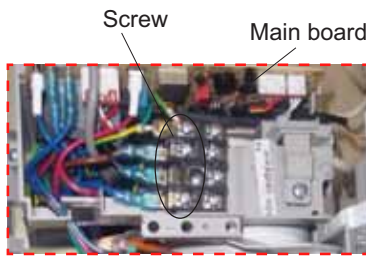
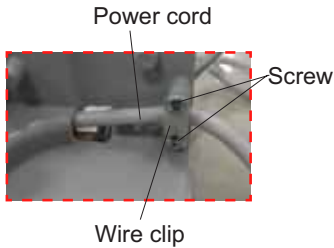
Step	Procedure
7. Remove electric box assy	
a	<p>Loosen the connection clasps between shield cover of electric box sub-assy and electric box, and then remove the shield cover of electric box sub-assy. Remove the screw fixing electric box assy .</p> 
b	<p>① Take off the water retaining sheet. Remove the cold plasma generator by screwing off the locking screw on the generator. ② Take off the indoor tube temperature sensor. ③ Screw off 1 grounding screw. ④ Remove the wiring terminals of motor and stepping motor. ⑤ Remove the electric box assy.</p> 
c	<p>Twist off the screws that are locking each lead wire and rotate the electric box assy. Twist off the screws that are locking the wire clip. Loosen the power cord and remove its wiring terminal. Lift up the main board and take it off.</p>  

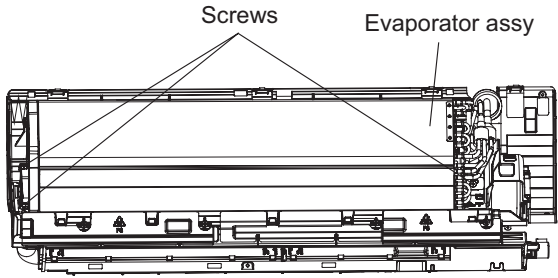
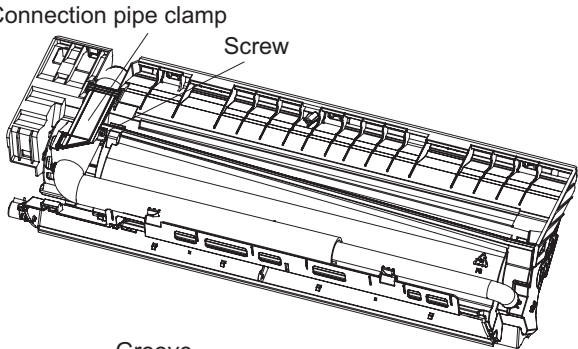
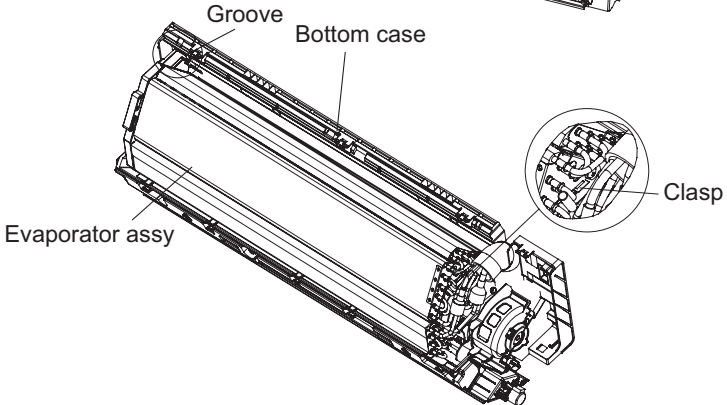
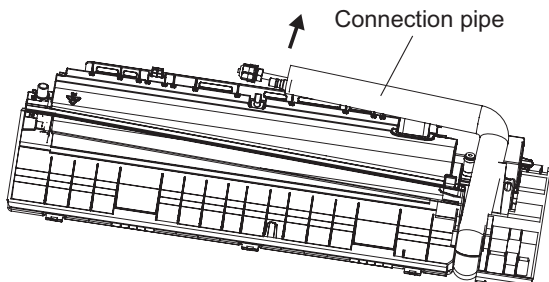
Step	Procedure	Image
	<p>Instruction: Some wiring terminal of this product is with lock catch and other devices. The pulling method is as below:</p> <p>1.Remove the soft sheath for some terminals at first, hold the circlip and then pull out the terminals.</p> <p>2.Pull out the holder for some terminals at first (holder is not available for some wiring terminal), hold the connector and then pull the terminal.</p>	 <p>Labels: circlip, soft sheath, holder, connector</p>
8. Remove evaporator assy		
a	Remove 3 screws fixing evaporator assy.	 <p>Labels: Screws, Evaporator assy</p>
b	At the back of the unit, remove the screw fixing connection pipe clamp and then remove the connection pipe clamp.	 <p>Labels: Connection pipe clamp, Screw</p>
c	First remove the left side of the evaporator from the groove of bottom case and then remove the right side from the clasp on the bottom case.	 <p>Labels: Groove, Bottom case, Evaporator assy, Clasp</p>
d	Adjust the position of connection pipe on evaporator slightly and then lift the evaporator upwards to remove it.	 <p>Labels: Connection pipe</p>

Step	Procedure
9. Remove motor and cross flow blade	
a	<p>Remove the screws fixing motor clamp and then remove the motor clamp.</p>
b	<p>Remove the screws at the connection place of cross flow blade and motor; lift the motor and cross flow blade upwards to remove them. Remove the bearing holder sub-assy. Remove the screw fixing step motor and then remove the step motor.</p>

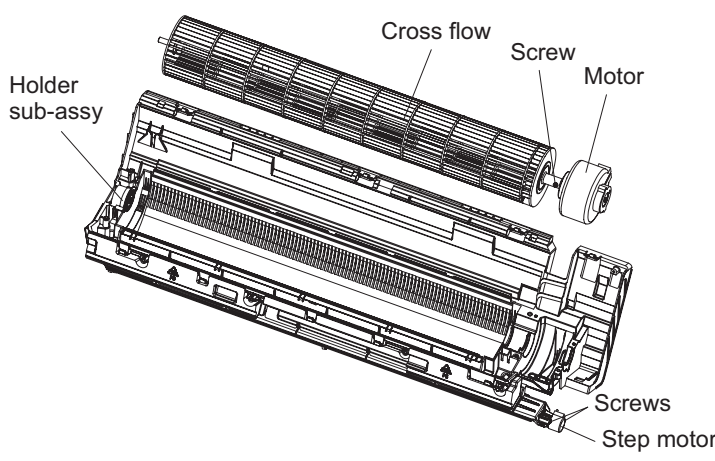
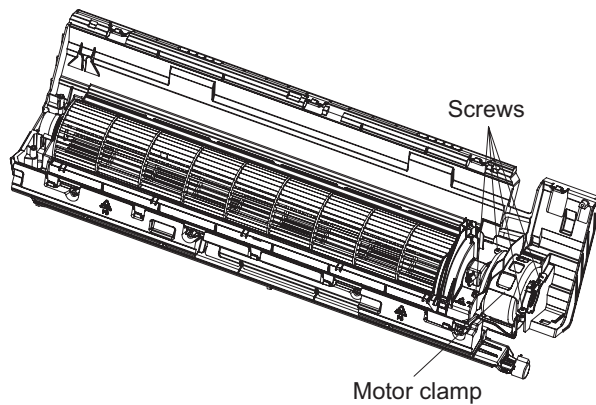

11.2 Removal Procedure of Outdoor Unit

⚠ Warning: Be sure to wait for a minimum of 20 minutes after turning off all power supplies and discharge the refrigerant completely before removal.

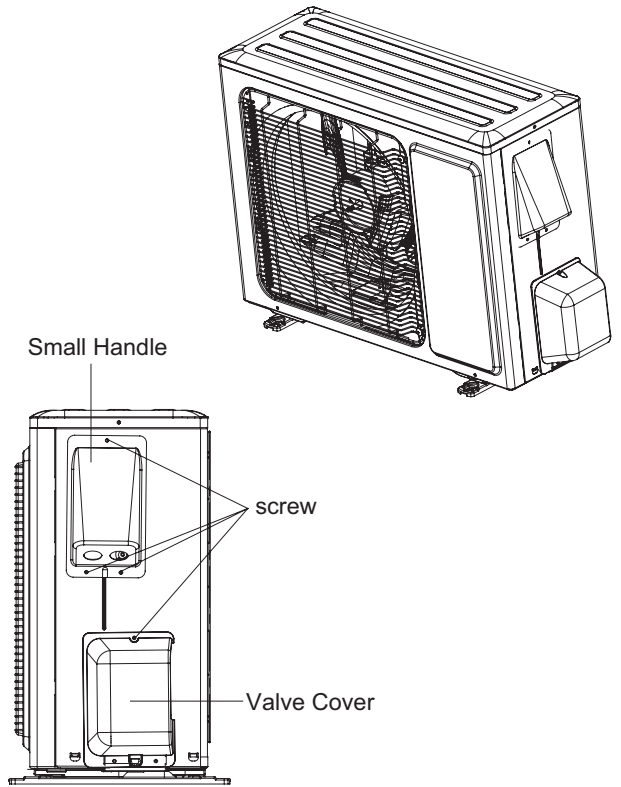
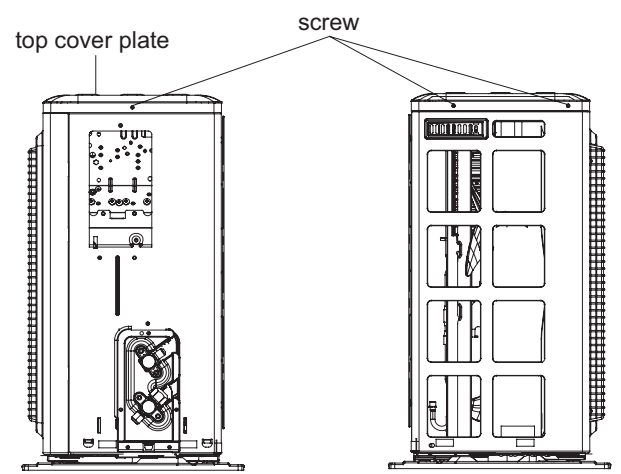
Steps	Procedure
<p>1.Remove big handle</p> <p>Before disassamble .</p> <p>Remove 3 connection screw fixing small handle and then remove the big handle.</p> <p>Remove 1 connection screw fixing valve cover and then remove the valve cover.</p>	 <p>The diagram shows an outdoor unit from a three-quarter perspective at the top. Below it, a front view shows a 'Small Handle' at the top, secured by three 'screw's. Below the handle is a 'Valve Cover' secured by one 'screw'.</p>
<p>2. Remove top cover</p> <p>Remove 3 connection screws among top cover plate, front panel and right side plate. Then remove top cover plate.</p>	 <p>The diagram shows two views of the outdoor unit. The left view shows the 'top cover plate' being removed, with three 'screw's indicated. The right view shows the unit with the top cover plate removed, revealing the internal components.</p>

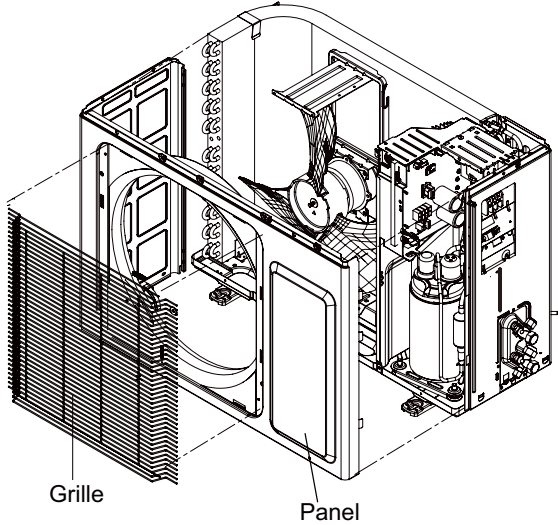
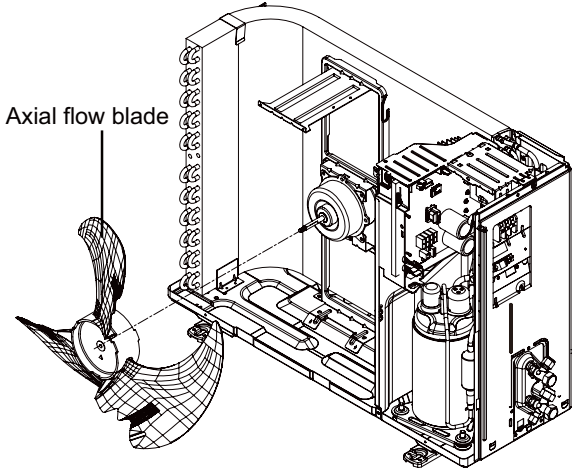
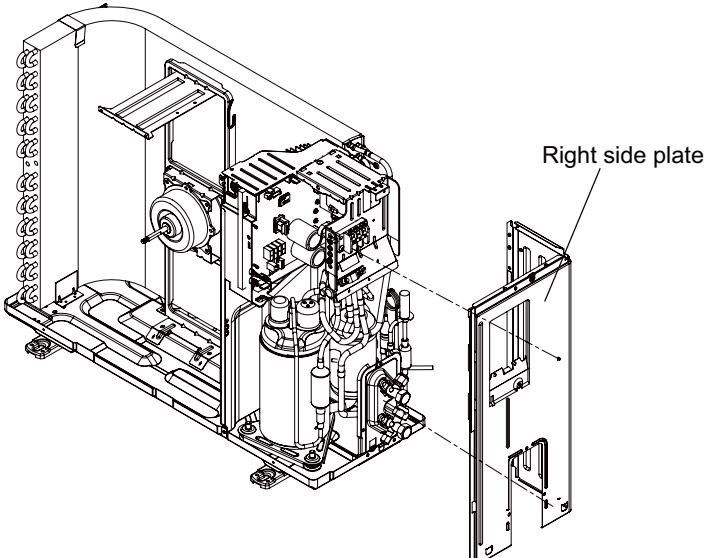
Steps	Procedure
3.Remove grille and front panel	<p>Remove connection screws between the front grille and the front panel. Then remove the front grille. Remove connection screws connecting the front panel with the chassis and the motor support, and then remove the front panel.</p>  <p>Grille</p> <p>Panel</p>
4.Remove axial flow blade	<p>Remove the nut fixing the blade and then remove the axial flow blade.</p>  <p>Axial flow blade</p>
5.Remove right side plate	<p>Remove connection screws connecting the right side plate with the valve support and the electric box. Then remove the right side plate.</p>  <p>Right side plate</p>

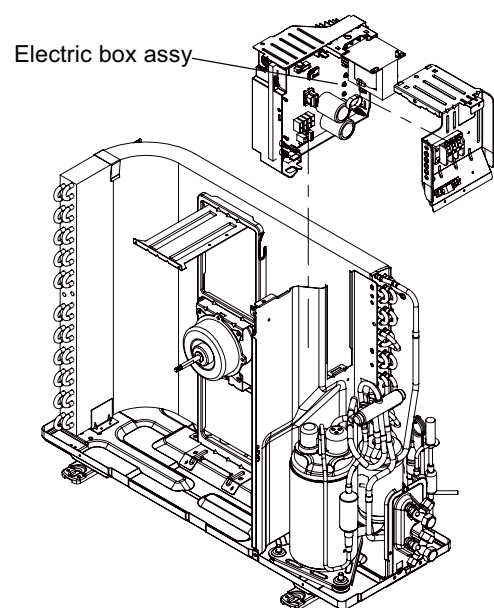
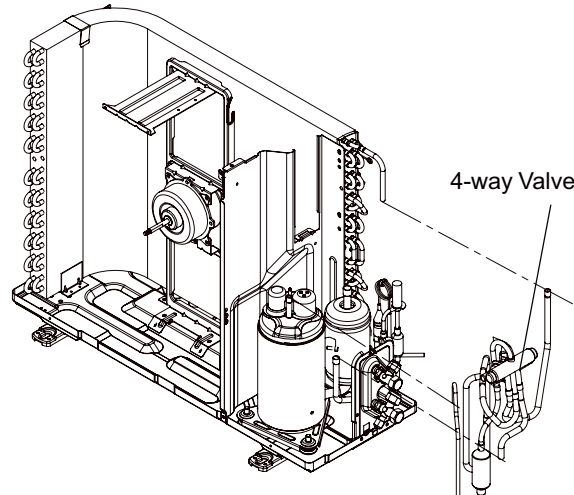
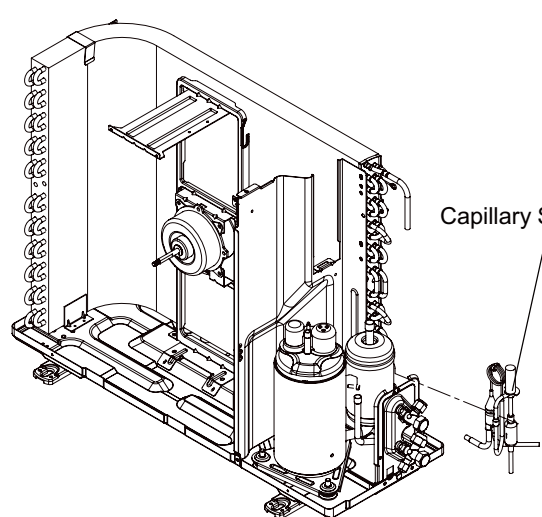
Steps	Procedure
<p>6.Remove electric box assy</p>	<p>Remove the 2 screws fixing the cover of electric box. Lift to remove the cover. Loosen the wire and disconnect the terminal. Lift to remove the electric box assy.</p>  <p>Electric box assy</p>
<p>7.Remove 4-way valve assy</p>	<p>Unscrew the fastening nut of the 4-way Valve Assy coil and remove the coil. Wrap the 4-way Valve Assy with wet cotton and unsolder the 4 weld spots connecting the 4-way Valve Assy to take it out.(Note: Refrigerant should be discharged firstly.) Welding process should be as quickly as possible and keep wrapping cotton wet all the time. Be sure not to burn out the lead-out wire of compressor.</p>  <p>4-way Valve Assy</p>
<p>8.Remove capillary sub-assy</p>	<p>Unsolder weld point of capillary Sub-assy, valve and outlet pipe of condensator. Then remove the capillary Sub-assy. Do not block the capillary when unsoldering it. (Note: before unsoldering,discharge refrigerants completely)</p>  <p>Capillary Sub-assy</p>

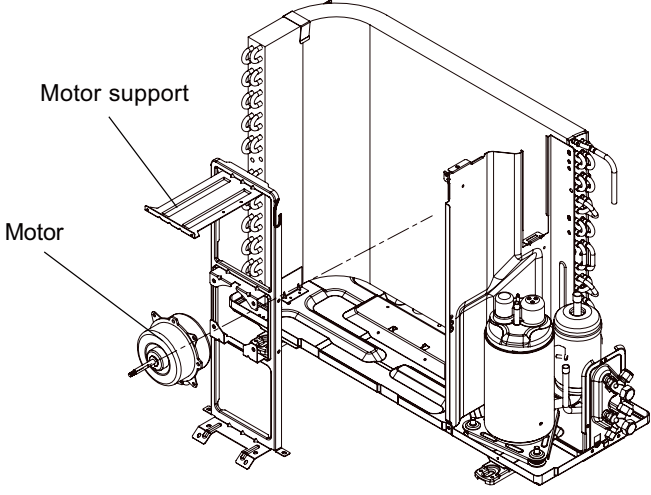
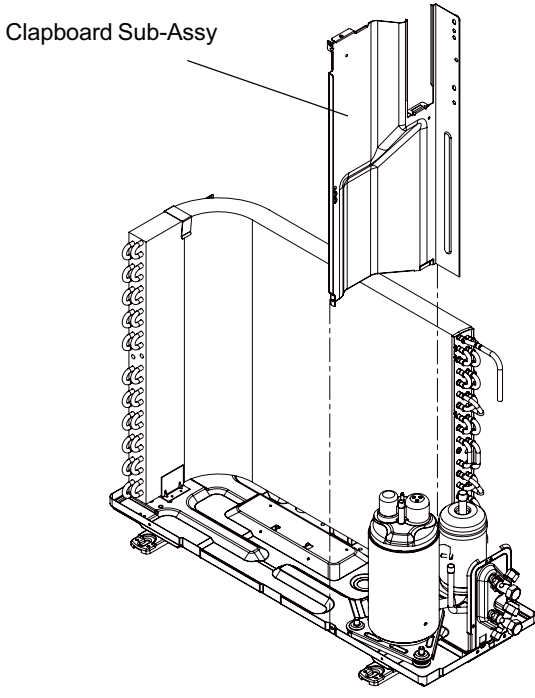
Steps	Procedure
<p>9.Remove motor and motor support</p>	<p>Remove the 4 tapping screws fixing the motor. Pull out the lead-out wire and remove the motor. Remove the 2 tapping screws fixing the motor support. Lift motor support to remove it.</p> 
<p>10.Remove clapboard sub-assy</p>	<p>Loosen the screws of the Clapboard Sub-Assy . The Clapboard Sub-Assy has a hook on the lower side. Lift and pull the Clapboard Sub-Assy to remove.</p> 

Appendix:

Appendix 1: Reference Sheet of Celsius and Fahrenheit

Conversion formula for Fahrenheit degree and Celsius degree: $T_f = T_c \times 1.8 + 32$

Set temperature

Fahrenheit display temperature (°F)	Fahrenheit (°F)	Celsius (°C)	Fahrenheit display temperature (°F)	Fahrenheit (°F)	Celsius (°C)	Fahrenheit display temperature (°F)	Fahrenheit (°F)	Celsius (°C)
61	60.8	16	69/70	69.8	21	78/79	78.8	26
62/63	62.6	17	71/72	71.6	22	80/81	80.6	27
64/65	64.4	18	73/74	73.4	23	82/83	82.4	28
66/67	66.2	19	75/76	75.2	24	84/85	84.2	29
68	68	20	77	77	25	86	86	30

Ambient temperature

Fahrenheit display temperature (°F)	Fahrenheit (°F)	Celsius (°C)	Fahrenheit display temperature (°F)	Fahrenheit (°F)	Celsius (°C)	Fahrenheit display temperature (°F)	Fahrenheit (°F)	Celsius (°C)
32/33	32	0	55/56	55.4	13	79/80	78.8	26
34/35	33.8	1	57/58	57.2	14	81	80.6	27
36	35.6	2	59/60	59	15	82/83	82.4	28
37/38	37.4	3	61/62	60.8	16	84/85	84.2	29
39/40	39.2	4	63	62.6	17	86/87	86	30
41/42	41	5	64/65	64.4	18	88/89	87.8	31
43/44	42.8	6	66/67	66.2	19	90	89.6	32
45	44.6	7	68/69	68	20	91/92	91.4	33
46/47	46.4	8	70/71	69.8	21	93/94	93.2	34
48/49	48.2	9	72	71.6	22	95/96	95	35
50/51	50	10	73/74	73.4	23	97/98	96.8	36
52/53	51.8	11	75/76	75.2	24	99	98.6	37
54	53.6	12	77/78	77	25			

Appendix 2: Configuration of Connection Pipe

1. Standard length of connection pipe

- 16.40ft, 24.61ft, 26.25ft.

2. Min. length of connection pipe is 9.84ft.

3. Max. length of connection pipe and max. high difference.

4. The additional refrigerant oil and refrigerant charging required after prolonging connection pipe

- After the length of connection pipe is prolonged for 32.81ft at the basis of standard length, you should add 0.0013gal of refrigerant oil for each additional 16.40ft of connection pipe.
- The calculation method of additional refrigerant charging amount (on the basis of liquid pipe):

Cooling capacity	Max length of connection pipe	Max height difference
5000 Btu/h(1465 W)	49.21ft	16.40ft
7000 Btu/h(2051 W)	49.21ft	16.40ft
9000 Btu/h(2637 W)	49.21ft	32.81ft
12000 Btu/h(3516 W)	65.62ft	32.81ft
18000 Btu/h(5274 W)	82.02ft	32.81ft
24000 Btu/h(7032 W)	82.02ft	32.81ft
28000 Btu/h(8204 W)	98.43ft	32.81ft
36000 Btu/h(10548 W)	98.43ft	65.62ft
42000 Btu/h(12306 W)	98.43ft	65.62ft
48000 Btu/h(14064 W)	98.43ft	65.62ft

- When the length of connection pipe is above 16.40ft, add refrigerant according to the prolonged length of liquid pipe. The additional refrigerant charging amount per meter is different according to the diameter of liquid pipe. See the following sheet.

- Additional refrigerant charging amount = prolonged length of liquid pipe X additional refrigerant charging amount per meter

Additional refrigerant charging amount for R22, R407C, R410A and R134a			
Diameter of connection pipe		Outdoor unit throttle	
Liquid pipe(inch)	Gas pipe(inch)	Cooling only(oz./ft.)	Cooling and heating(oz./ft.)
Φ0.24	Φ0.37 or Φ0.47	0.2	0.2
Φ0.24 or Φ0.37	Φ0.63 or Φ0.75	0.2	0.2
Φ0.47	Φ0.75 or Φ0.87	0.3	1.3
Φ0.63	Φ1 or Φ1.25	0.7	1.3
Φ0.75	/	2.7	2.7
Φ0.87	/	3.8	3.8

Appendix 3: Pipe Expanding Method

Note:

Improper pipe expanding is the main cause of refrigerant leakage. Please expand the pipe according to the following steps:

A: Cut the pipe

- Confirm the pipe length according to the distance of indoor unit and outdoor unit.
- Cut the required pipe with pipe cutter.

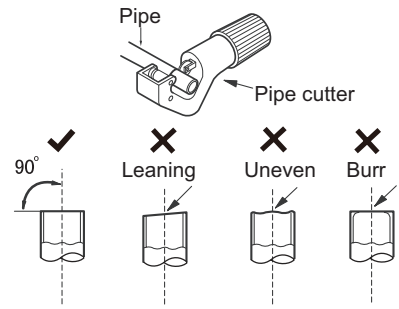

B: Remove the burrs

- Remove the burrs with shaper and prevent the burrs from getting into the pipe.

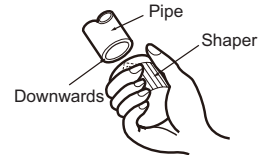

C: Put on suitable insulating pipe

D: Put on the union nut

- Remove the union nut on the indoor connection pipe and outdoor valve; install the union nut on the pipe.

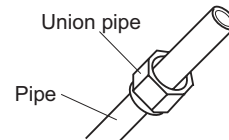

E: Expand the port

- Expand the port with expander.

Note:

- "A" is different according to the diameter, please refer to the sheet below:

Outer diameter(inch)	A(inch)	
	Max	Min
Φ0.24 - 0.25 (1/4")	0.05	0.03
Φ0.37 (3/8")	0.06	0.04
Φ0.47 - 0.50 (1/2")	0.07	0.04
Φ0.63 - 0.625 (5/8")	0.09	0.09

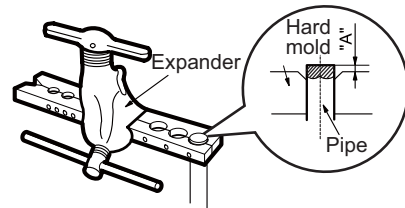

F: Inspection

- Check the quality of expanding port. If there is any blemish, expand the port again according to the steps above.

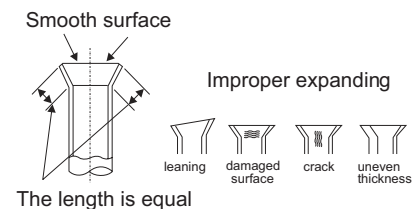

Appendix 4: List of Resistance for Temperature Sensor

Resistance Table of Ambient Temperature Sensor for Indoor and Outdoor(15K)

Temp.(°F)	Resistance(kΩ)	Temp.(°F)	Resistance(kΩ)	Temp.(°F)	Resistance(kΩ)	Temp.(°F)	Resistance(kΩ)
-2.2	138.1	68	18.75	138.2	3.848	208.4	1.071
-0.4	128.6	69.8	17.93	140	3.711	210.2	1.039
1.4	121.6	71.6	17.14	141.8	3.579	212	1.009
3.2	115	73.4	16.39	143.6	3.454	213.8	0.98
5	108.7	75.2	15.68	145.4	3.333	215.6	0.952
6.8	102.9	77	15	147.2	3.217	217.4	0.925
8.6	97.4	78.8	14.36	149	3.105	219.2	0.898
10.4	92.22	80.6	13.74	150.8	2.998	221	0.873
12.2	87.35	82.4	13.16	152.6	2.896	222.8	0.848
14	82.75	84.2	12.6	154.4	2.797	224.6	0.825
15.8	78.43	86	12.07	156.2	2.702	226.4	0.802
17.6	74.35	87.8	11.57	158	2.611	228.2	0.779
19.4	70.5	89.6	11.09	159.8	2.523	230	0.758
21.2	66.88	91.4	10.63	161.6	2.439	231.8	0.737
23	63.46	93.2	10.2	163.4	2.358	233.6	0.717
24.8	60.23	95	9.779	165.2	2.28	235.4	0.697
26.6	57.18	96.8	9.382	167	2.206	237.2	0.678
28.4	54.31	98.6	9.003	168.8	2.133	239	0.66
30.2	51.59	100.4	8.642	170.6	2.064	240.8	0.642
32	49.02	102.2	8.297	172.4	1.997	242.6	0.625
33.8	46.6	104	7.967	174.2	1.933	244.4	0.608
35.6	44.31	105.8	7.653	176	1.871	246.2	0.592
37.4	42.14	107.6	7.352	177.8	1.811	248	0.577
39.2	40.09	109.4	7.065	179.6	1.754	249.8	0.561
41	38.15	111.2	6.791	181.4	1.699	251.6	0.547
42.8	36.32	113	6.529	183.2	1.645	253.4	0.532
44.6	34.58	114.8	6.278	185	1.594	255.2	0.519
46.4	32.94	116.6	6.038	186.8	1.544	257	0.505
48.2	31.38	118.4	5.809	188.6	1.497	258.8	0.492
50	29.9	120.2	5.589	190.4	1.451	260.6	0.48
51.8	28.51	122	5.379	192.2	1.408	262.4	0.467
53.6	27.18	123.8	5.197	194	1.363	264.2	0.456
55.4	25.92	125.6	4.986	195.8	1.322	266	0.444
57.2	24.73	127.4	4.802	197.6	1.282	267.8	0.433
59	23.6	129.2	4.625	199.4	1.244	269.6	0.422
60.8	22.53	131	4.456	201.2	1.207	271.4	0.412
62.6	21.51	132.8	4.294	203	1.171	273.2	0.401
64.4	20.54	134.6	4.139	204.8	1.136	275	0.391
66.2	19.63	136.4	3.99	206.6	1.103	276.8	0.382

Resistance Table of Tube Temperature Sensors for Indoor and Outdoor (20K)

Temp.(°F)	Resistance(kΩ)	Temp.(°F)	Resistance(kΩ)	Temp.(°F)	Resistance(kΩ)	Temp.(°F)	Resistance(kΩ)
-2.2	181.4	68	25.01	138.2	5.13	208.4	1.427
-0.4	171.4	69.8	23.9	140	4.948	210.2	1.386
1.4	162.1	71.6	22.85	141.8	4.773	212	1.346
3.2	153.3	73.4	21.85	143.6	4.605	213.8	1.307
5	145	75.2	20.9	145.4	4.443	215.6	1.269
6.8	137.2	77	20	147.2	4.289	217.4	1.233
8.6	129.9	78.8	19.14	149	4.14	219.2	1.198
10.4	123	80.6	18.13	150.8	3.998	221	1.164
12.2	116.5	82.4	17.55	152.6	3.861	222.8	1.131
14	110.3	84.2	16.8	154.4	3.729	224.6	1.099
15.8	104.6	86	16.1	156.2	3.603	226.4	1.069
17.6	99.13	87.8	15.43	158	3.481	228.2	1.039
19.4	94	89.6	14.79	159.8	3.364	230	1.01
21.2	89.17	91.4	14.18	161.6	3.252	231.8	0.983
23	84.61	93.2	13.59	163.4	3.144	233.6	0.956
24.8	80.31	95	13.04	165.2	3.04	235.4	0.93
26.6	76.24	96.8	12.51	167	2.94	237.2	0.904
28.4	72.41	98.6	12	168.8	2.844	239	0.88
30.2	68.79	100.4	11.52	170.6	2.752	240.8	0.856
32	65.37	102.2	11.06	172.4	2.663	242.6	0.833
33.8	62.13	104	10.62	174.2	2.577	244.4	0.811
35.6	59.08	105.8	10.2	176	2.495	246.2	0.77
37.4	56.19	107.6	9.803	177.8	2.415	248	0.769
39.2	53.46	109.4	9.42	179.6	2.339	249.8	0.746
41	50.87	111.2	9.054	181.4	2.265	251.6	0.729
42.8	48.42	113	8.705	183.2	2.194	253.4	0.71
44.6	46.11	114.8	8.37	185	2.125	255.2	0.692
46.4	43.92	116.6	8.051	186.8	2.059	257	0.674
48.2	41.84	118.4	7.745	188.6	1.996	258.8	0.658
50	39.87	120.2	7.453	190.4	1.934	260.6	0.64
51.8	38.01	122	7.173	192.2	1.875	262.4	0.623
53.6	36.24	123.8	6.905	194	1.818	264.2	0.607
55.4	34.57	125.6	6.648	195.8	1.736	266	0.592
57.2	32.98	127.4	6.403	197.6	1.71	267.8	0.577
59	31.47	129.2	6.167	199.4	1.658	269.6	0.563
60.8	30.04	131	5.942	201.2	1.609	271.4	0.549
62.6	28.68	132.8	5.726	203	1.561	273.2	0.535
64.4	27.39	134.6	5.519	204.8	1.515	275	0.521
66.2	26.17	136.4	5.32	206.6	1.47	276.8	0.509

Resistance Table of Discharge Temperature Sensor for Outdoor(50K)

Temp.(°F)	Resistance(kΩ)	Temp.(°F)	Resistance(kΩ)	Temp.(°F)	Resistance(kΩ)	Temp.(°F)	Resistance(kΩ)
-20.2	853.5	50	98	120.2	18.34	190.4	4.754
-18.4	799.8	51.8	93.42	122	17.65	192.2	4.609
-16.6	750	53.6	89.07	123.8	16.99	194	4.469
-14.8	703.8	55.4	84.95	125.6	16.36	195.8	4.334
-13	660.8	57.2	81.05	127.4	15.75	197.6	4.204
-11.2	620.8	59	77.35	129.2	15.17	199.4	4.079
-9.4	580.6	60.8	73.83	131	14.62	201.2	3.958
-7.6	548.9	62.6	70.5	132.8	14.09	203	3.841
-5.8	516.6	64.4	67.34	134.6	13.58	204.8	3.728
-4	486.5	66.2	64.33	136.4	13.09	206.6	3.619
-2.2	458.3	68	61.48	138.2	12.62	208.4	3.514
-0.4	432	69.8	58.77	140	12.17	210.2	3.413
1.4	407.4	71.6	56.19	141.8	11.74	212	3.315
3.2	384.5	73.4	53.74	143.6	11.32	213.8	3.22
5	362.9	75.2	51.41	145.4	10.93	215.6	3.129
6.8	342.8	77	49.19	147.2	10.54	217.4	3.04
8.6	323.9	78.8	47.08	149	10.18	219.2	2.955
10.4	306.2	80.6	45.07	150.8	9.827	221	2.872
12.2	289.6	82.4	43.16	152.6	9.489	222.8	2.792
14	274	84.2	41.34	154.4	9.165	224.6	2.715
15.8	259.3	86	39.61	156.2	8.854	226.4	2.64
17.6	245.6	87.8	37.96	158	8.555	228.2	2.568
19.4	232.6	89.6	36.38	159.8	8.268	230	2.498
21.2	220.5	91.4	34.88	161.6	7.991	231.8	2.431
23	209	93.2	33.45	163.4	7.726	233.6	2.365
24.8	198.3	95	32.09	165.2	7.47	235.4	2.302
26.6	199.1	96.8	30.79	167	7.224	237.2	2.241
28.4	178.5	98.6	29.54	168.8	6.998	239	2.182
30.2	169.5	100.4	28.36	170.6	6.761	240.8	2.124
32	161	102.2	27.23	172.4	6.542	242.6	2.069
33.8	153	104	26.15	174.2	6.331	244.4	2.015
35.6	145.4	105.8	25.11	176	6.129	246.2	1.963
37.4	138.3	107.6	24.13	177.8	5.933	248	1.912
39.2	131.5	109.4	23.19	179.6	5.746	249.8	1.863
41	125.1	111.2	22.29	181.4	5.565	251.6	1.816
42.8	119.1	113	21.43	183.2	5.39	253.4	1.77
44.6	113.4	114.8	20.6	185	5.222	255.2	1.725
46.4	108	116.6	19.81	186.8	5.06	257	1.682
48.2	102.8	118.4	19.06	188.6	4.904	258.8	1.64

JF00302353



GREE ELECTRIC APPLIANCES, INC. OF ZHUHAI

Add: West Jinji Rd, Qianshan, Zhuhai, Guangdong, China 519070

Tel: (+86-756) 8522218 Fax: (+86-756) 8669426

Email: gree@gree.com.cn [Http://www.gree.com](http://www.gree.com)

HONG KONG GREE ELECTRIC APPLIANCES SALES LIMITED

Add: Unit 2612, 26/F., Miramar Tower 132 Nathan Road, TST, Kowloon, HK

Tel: (852) 31658898 Fax: (852) 31651029

For product improvement, specifications and appearance in this manual are subject to change without prior notice.