

SUBMITTAL DATA

GMV-ND07C/A-T(U) for use with VRF Outdoor Unit
7000 BTU/H Console Unit

Job Name	Location	Date
Purchaser	Engineer	
Submitted to	For	
Unit Designation	Schedule No.	

 <p>YAP1F</p>	 <p>GMV-ND07C/A-T(U)</p>	 <p>XK46 (Optional)</p>
--	---	--

GENERAL FEATURES

- Multiple Fan Speed
- Multiple Protections (Anti-freezing, Temperature Sensor Malfunction, Fan Motor Overload Protection)
- Detachable Grille and Long Life Filter
- Wireless Remote with LCD Display
- Wired Controller Options
- Performance Based On Outdoor Unit
- Coil (Indoor and Outdoor) Copper Tube / Aluminum Fin
- Blue Colored Fin - 500 Hrs Salt Spray Tested

SPECIFICATIONS, FEATURES & FUNCTION SUMMARY

SPECIFICATIONS		GMV-ND07C/A-T(U)		FEATURES & FUNCTIONS SUMMARY		GMV-ND07C/A-T(U)		
System Type		HEAT PUMP						
SYSTEM PERFORMANCE				SYSTEM FEATURES				
Cooling	Nominal	Btu/h	7500	Wired Controller Interface	Yes			
	Capacity @95°F	Btu/h		WiFi Included	No			
Heating	Nominal	Btu/h	8500	Easy Service Access	Yes			
	Capacity @5°F	Btu/h		Indoor Fan Type	Centrifugal			
	Capacity @17°F	Btu/h		Multi Fan Speeds	3 Speeds			
	Capacity @47°F	W		Indoor Unit Display	Yes			
SEER2				Auxiliary Electrical Heater	No			
EER2				Ventilation (Outdoor Air)	No			
HSPF2				REMOTE CONTROLLER FUNCTIONS				
COP @5°F	System Performance Based on the Connected Outdoor Unit Performance			Auto Mode	Yes			
COP @47°F				Auto Fan	Yes			
Cooling Temperature Range				°F	Auto Swing (Horizontal Auto Swing)	Yes		
Heating Temperature Range				°F	Auto Swing - 180° (Vertical Auto Swing)	Yes		
Refrigerant Type				R410A		Clock	Yes	
INDOOR UNIT		GMV-ND07C/A-T(U)		Dry Mode	Yes			
Air flow (Min-Max)	CFM	159 - 235		Dry Anti-Mildew (X-Fan) Mode	Yes			
Sound Pressure Level (Min - Max)	dB(A)	27 - 38		Energy Saving Mode	Yes			
Condensate Drain Size (OD)	in	1		Dirty Filter Alert	No			
External Dimensions (WxHxD)	in	27-1/2 x 23-5/8 x 8-1/2		Fan Speed Control (7 Speeds)	Yes			
Package Dimension (W x H x D)	in	31 x 30-5/8 x 11-1/8		I Feel Function	Yes			
Net Weight	lbs	35		Privacy Lock	Yes			
Gross Weight	lbs	42		Quiet Mode	Yes			
REFRIGERANT PIPING				Room Temperature Display	No			
Line Set Sized by the Indoor Unit (Liquid - Gas)	in	1/4 - 3/8		Sleep Mode	Yes			
ELECTRICAL				3 Sleep Mode Options	Yes			
Power Supply	208-230V / 1Ph / 60Hz (Powered by the Outdoor Unit)			Timer Mode	Yes			
MCA	A	1		Turbo Mode	Yes			
MOCP	A	15		Display On/Off Control	Yes			
				Freeze Guard Mode	Yes			
				Power Failure Mode	Yes			

DIMENSIONS & CLEARANCES

INDOOR UNIT

Unit: inch

GMV-ND07C/A-T(U)

DIMENSIONS & CLEARANCES

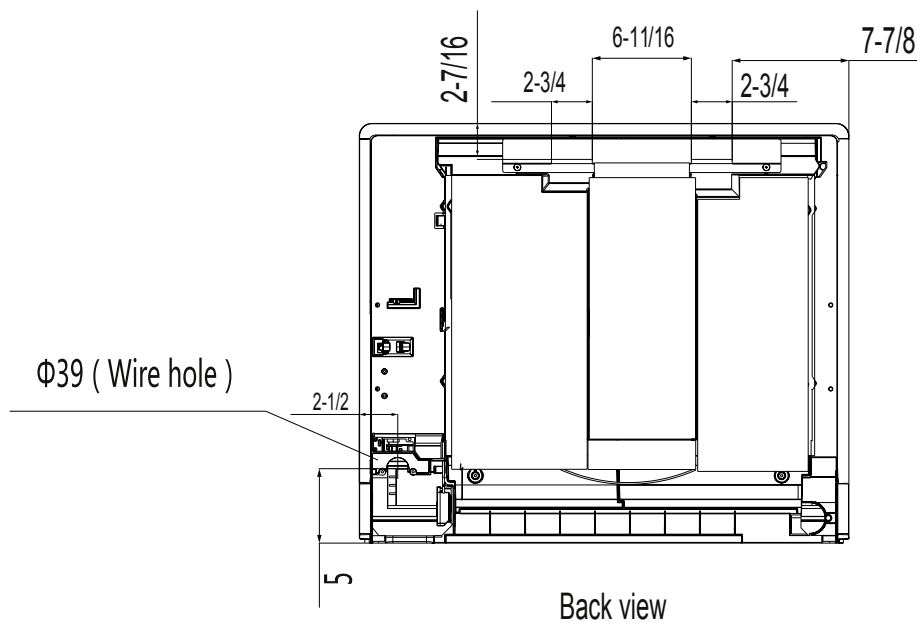
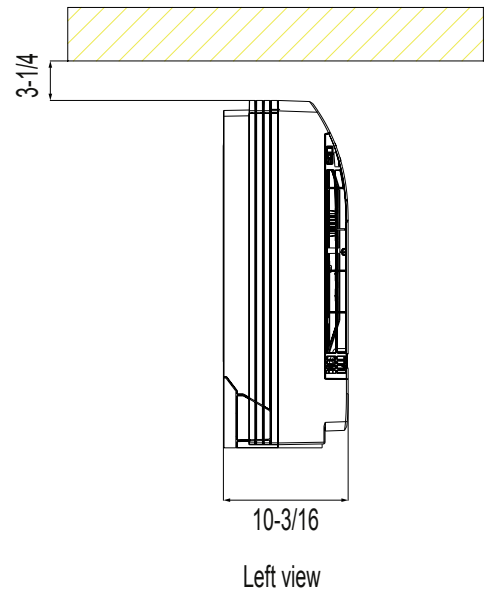
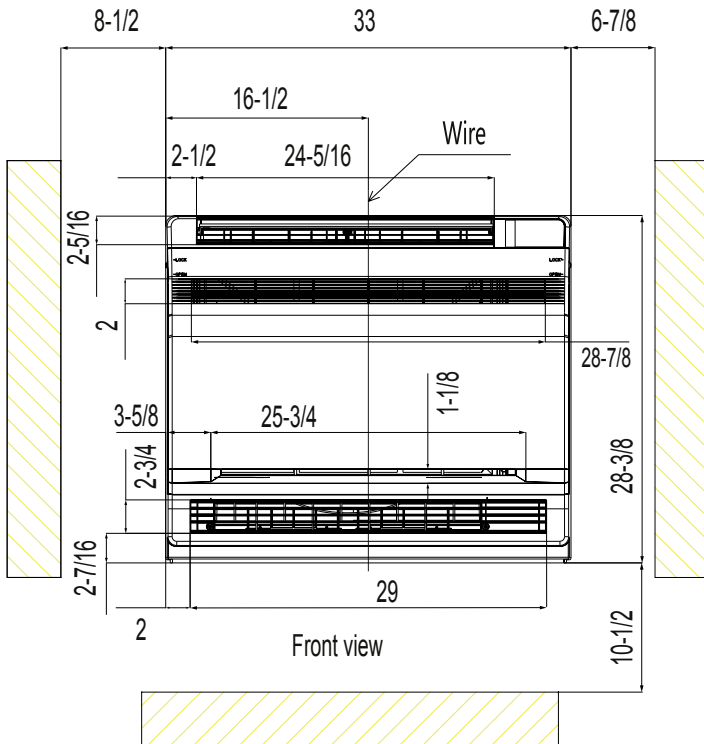

Specifications are subject to change without notice. Manufacturer reserves the right to discontinue or modify specifications or designs without notice or without incurring obligations. All Rights reserved.

GREECOMMERCIAL.COM/SYSTEM-DOCUMENTATION