

Super High Fan Coil 208~230V



Job Name: _____ Date: _____

System Reference No.: _____ Engineer Signature: _____

Model: GMV-ND07PHS/B-T(U)



Specifications	Unit	Parameter
Performance		GMV-ND07PHS/B-T(U)
Rated Cooling Capacity	kBtu/h	7.5
Rated Heating Capacity	kBtu/h	8.5
Sound Pressure Level (H/M/L)	dB(A)	35/33/31
Electrical Data		
Power supply	Voltage, Phase, Hertz	208/230, 1, 60
Minimum Circuit Amps (MCA)	A	1
Maximum Overcurrent Protection (MOP)	A	15
Fuse	A	15
Fan		
Type x Quantity		Centrifugal x 1
Air Flow Volume (H/M/L)	CFM	324/282/235
ESP	in.W.G.	0~0.6
Fan Motor Running Current	A	0.3
Fan Motor Power Input	W	150
Refrigerant Piping		
Connection Pipe	Gas (inch)	3/8
	Liquid (inch)	1/4
Connection Method		Brazing Connection
Refrigerant		R410A
Dimension/Weight		
Dimensions (WxDxH)	inch	27-9/16 x 27-9/16 x 11-13/16
Net Weight	lbs	73
Other		
Safety Certification		ETL

Outline and Physical Dimensions of GMV-ND07PHS/B-T(U).

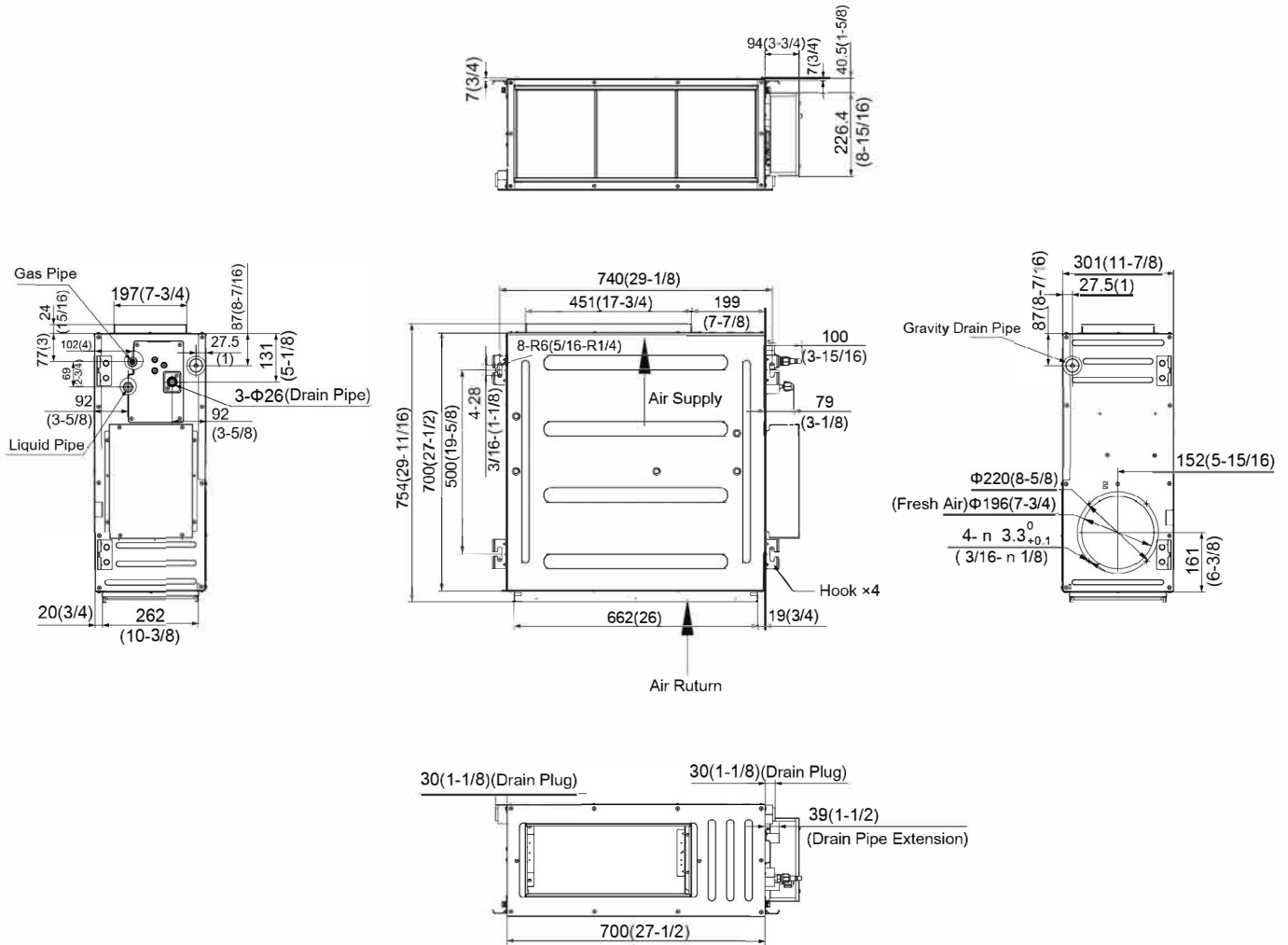

Unit:mm(in.)

